

PRICE LIST

APRIL
2023



LIVE THE ADVANTAGE





Power

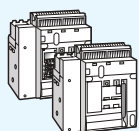

P. 15
DMX³ ACB from
630 A to 6300 A
Fixed version

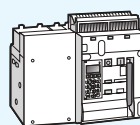

P. 16
DMX³ ACB from
630 A to 6300 A
Draw out version

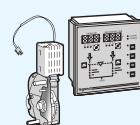

P. 18
Auxiliaries &
Accessories



P. 21
DMX SP 2500
Protection Units



P. 24
DRX MCCBs

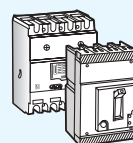

P. 25-39
DPX³ MCCBs &
Accessories

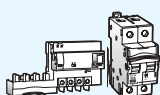

P. 56-57
E-Communicating
Infrastructure



P. 60
Power Supply

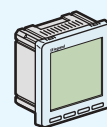

P. 63-64
EMDX³
Digital Meter



P. 78-81
MPCBs & MPX³
Accessories



P. 83
Alpx³ box type
capacitors standard
and heavy duty
440 V



P. 83
ALPX³ resin filled
capacitors standard
and heavy duty
440 V, 480 V & 525 V

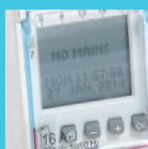

Protection, Isolation, Controlling, Signalling, Metering.

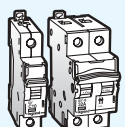

P. 88-91
DX³ MCB
& Isolators



P. 93-94
DX³ RCD
add-on module
with metering

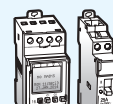

P. 94-95
DX³ Time switches
and Contactors



P. 100
Time lag switches

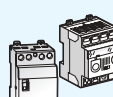

P. 100
Lexic dimmer and
Power contactors



P. 100
Lexic
Time delay
relay

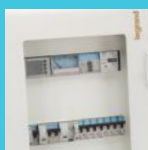

Distribution Boards



P. 105
Ekinox³
SPN & ETPN DBs

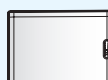

P. 106
Ekinox³
TPN DB-VTPN



P. 106-107 **NEW!**
Ekinox³
Phase Selector Neo DB,
TPN DB- 7/8 segment

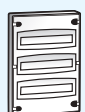

P. 109
Ekinox³ DBs
Plexo 3 boxes for
DX³ and Accessories



Arteor™ Wiring Accessories

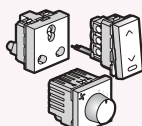

P. 124-125
Square- White
mechanism- Switches, Push
buttons, Dimmers, Regulators,
Indian standard sockets

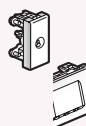

P. 125-126
Square- White
mechanism--USB Chargers, Data & voice,
Hotel functions, Audio Video, Energy plugs, USB
Charger, RJ11 Telephone Sockets, Information
outlets

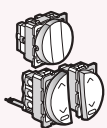

P. 129-130
Square Champagne
mechanisms-Data & voice,
Hotel functions, Audio Video,
Energy plugs, USB Charger

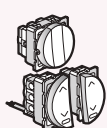

P. 130-131
Round- White
mechanism-
Switches,
Push buttons



P. 131-132
Round- Magnesium
mechanism- Switches,
Push buttons, Dimmers,
Regulators and Electronic
Functions



P. 144
Arteor™
Connected Home

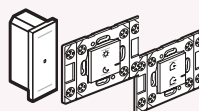

P. 144
White, Magnesium & Champagne Mechanism-
connected light switches, outlets, gateway pack,
wireless controls & wireless scene switches



P. 18
DMX³ ACB, Protection
Units, Locking, ACU,
Cable interlock &
Accessories

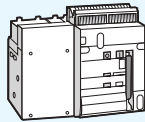

P. 20
DMX SP 2500 Switch
disconnectors 630 A
to 2500 A Fixed version
Draw-out version

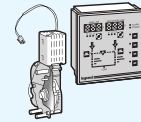

P. 21
Auxillaries &
Accessories

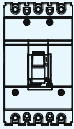

P. 42
DRX 125
MCCBs



P. 43-47
DRX 125,
250^{HP} & 630
MCCBs & Accessories

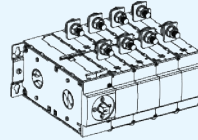

P. 55
DSX



P. 66-68
PMX
Digital Panel Meter

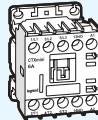

P. 70-72
CTX³ contactors

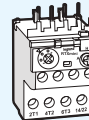

P. 73-74
RTX³
thermal relays

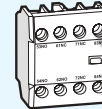

P. 75-77
CTX³
accessories



P. 84
Reactors and
power factor
controllers

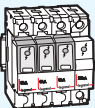

P. 96-99
SPD

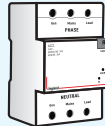

P. 99
ACCL

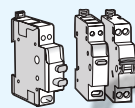

P. 99-100
DX3 changeover
switches,
Push buttons and
Indicators

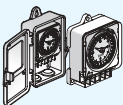

P. 100-101
Time switches and
Accessories



P. 107
Ekinox³
TPN DB - 7 Segment
& Metal Enclosures



P. 108
Ekinox³
P17 Tempra Plug
& Socket DBs



P. 108
Ekinox³
Metal
Enclosures

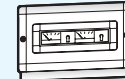

P. 108
Ekinox³
Cable end box,
Meter box, PPT Kit
& Accessories

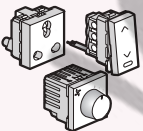

P. 126-127
Square- Magnesium
mechanism- Switches, Push
buttons, Dimmers, Regulators,
Indian standard sockets

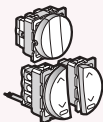

P. 127-128
Square Magnesium
mechanisms -Data & voice, Hotel
functions, Audio Video, Energy
plugs, USB Charger, RJ11

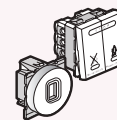

P. 128-129
Square- Champagne
mechanism- Switches, Push
buttons, Dimmers, Regulators,
Indian standard sockets

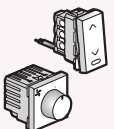

P.132
Round- Champagne
mechanism- Switches, Push
buttons, Dimmers, Regulators
and Electronic Functions

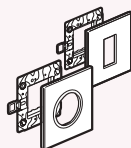

P. 132-136
Square cover plates,
Round cover plates

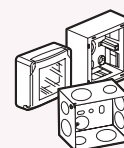

P. 137
Plastic surface,
Metal flush boxes,
Plexo boxes &
Accessories

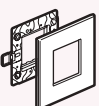

P. 145-147
COVER PLATES
White, Pearl Aluminium, Graphite, Magnesium, Champagne, Dark Bronze, Mirror, Silver
Baroque, Dark Baroque, Metal , Wood & Signature cover with overmoulded frame



P. 147
Cover plates without frame
& Accessories



**Myrius™
Accessories**

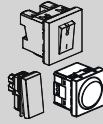

P. 152
Classic White Switches,
Push buttons, Dimmers
& Regulators, Emergency
Light



P. 152- 153
Hospitality Functions,
Sockets, Electronic
Function

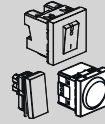

P. 154-155
Mechanisms Charcoal
Grey Switches, Push
buttons, Dimmers &
Regulators,
Emergency Light



P. 156-158
Plate With Frame
White, Ice White, Ice Black, Pearl Champagne,
Sonic Silver, Dark Fade, Interlude, Trinity,
Luminar & Stellar



P. 158
Plastic surface
boxes & Metal
surface boxes

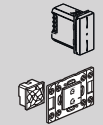

P. 164
Connected Home White & Charcoal Grey Mechanism
Light Switches, Connected outlets, Curtain/Roller binder, Gateway
pack, Wireless control, Wireless Scene Switches



**Myrius™
Regular**

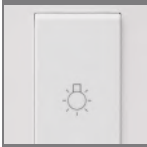

P. 172
Switches,
Push buttons, Sockets,
Dimmer and regulators

White mechanisms

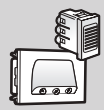

P. 172-173
Indicators,
Skirting light, Indicators,
Buzzers and Remote unit



P. 173-174
Hospitality
functions, Sockets
& connectors,
Data & voice



P. 175
Dimmer &
regulators, Switches
& Push buttons

Black mechanisms



P. 175
Indicators, Skirting
light, Indicators &
Buzzers.

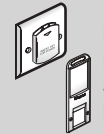

P. 175-176
Remote unit,
Hospitality functions,
Sockets & connectors,
Data & voice



**Mylinc™
Wiring
Accessories**

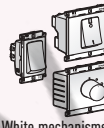

P. 181
Mylinc switches,
Dimmers and
Accessories
and remote unit

White mechanisms

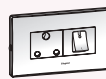

P. 181
Mylinc energy
sockets, Power
units and MCBs

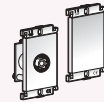

P. 181-182
Mylinc TV and
RJ 11 telephone
sockets and
Accessories



P. 182 - 183
Mylinc switches,
Dimmers, USB
charger, Remote unit
& Accessories

Grey mechanisms

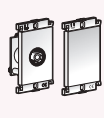

P. 183
Mylinc TV,
RJ 11 Telephone
Sockets &
Accessories

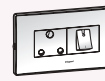

P.184
Mylinc energy
sockets,
Power units and
MCBs



**Lyncus™
Wiring
Accessories**

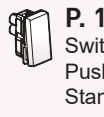

P. 187
Switches,
Push buttons,
Standard Sockets

White mechanisms



P.187
Dimmer and
regulators,
Hospitality
Functions

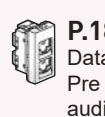

P.187-188
Data voice,
Pre terminated
audio video
connectors

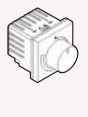

P. 188-189
Switches,
Push buttons,
Dimmer and regulators,
Accessories

Chic Grey Mechanism

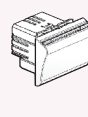

P.189
Hospitality
Functions,
Data voice,
Pre terminated



P. 189
Audio Video
Connectors, USB
chargers: Combi
Sockets + USB

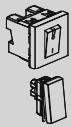

P. 155
Mechanisms Charcoal Grey
Hospitality Functions,
Sockets, Electronic Function

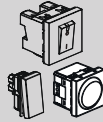

P. 155-156
Electronic Function,
Switches - Charcoal
Grey



P. 155-156
Mechanism
AntiBacterial &
Accessories



P. 158
Metal flush boxes



P. 164-167
Cover Frame
White, Ice White, Ice Black, Pearl Champagne,
Sonic Silver, Dark Fade, Interlude, Trinity,
Luminar & Stellar



P. 167
Cover plates without frame
& Accessories

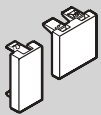

P. 173-174
Anti-Bacterial Switches
and Accessories



P. 173
USB chargers and
Audio & video con-
nectors

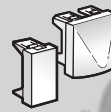

P. 173
Volume controller,
Protectors and
Accessories,
Modular MCBs



P. 176
White & Black
plastic plates

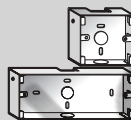

P. 176-177
Flush mounting &
Surface boxes



P. 182
Mylinc
Modular Plates -
White



P. 183
Mylinc modular
plates- Matt Grey, Pearl
white, Champagne,
Silver Alu, Dark Bronze

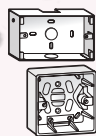

P. 184
Mylinc white
surrounds,
Flush & Surface
boxes



P. 188
USB Chargers:
Combi sockets + USB.



P. 189
sound diffusion
and loud speakers, Universal
dimmers, touch switches, reading
lights

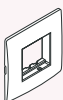

P. 189-190
Plate & Frame
White, Chic grey, Brushed
silver, Alu sunset,
Champagne, Matt silver

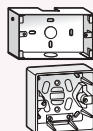

P. 191
Metal Flush box &
Plastic surface
boxes



Allzy ^{NEW} Wiring Accessories

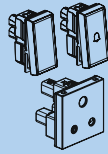

P. 196
Mechanisms White - Switches, Sockets & Dimmer and Fan Regulators

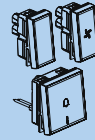

P. 196
Mechanisms White - Hospitality Functions, Sockets & Connectors & Protectors, Modular MCBs, Power Units and Accessories



Britzy™ Wiring Accessories

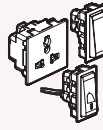

P. 201
Switches, sockets and push buttons

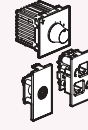

P. 201
Data & voice, television sockets, dimmers & regulators & accessories



Cable Management System and Accessories

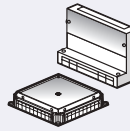

P. 212
Raceways & junction boxes for screed floors PVC, Metal and Accessories

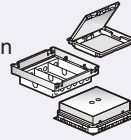

P. 213
Floor boxes for raised floor, Screed floor and tile/marble, Support Plates

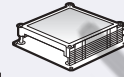

P. 214-218
Universal floor box, Heavy Duty in-screed floor box, Floor Boxes 3 module, Floor access unit for raised floors



P. 224-225
Selection chart: DLP PVC adaptable trunking system



P. 225
Selection Chart: DLP Mini Trunking Systems

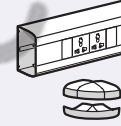

P. 228
Snap-On Trunking 45 mm, Routing sections and Accessories



VDI Structured Cabling

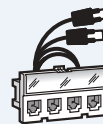

P. 233
LCS³, cat. 8 Patch Panels

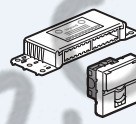

P. 233
LCS³, cat. 8 Cables and Cords

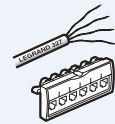

P. 233-236
LCS³, cat. 6A Patch panels, RJ 45, Cables and Cords

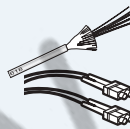

P. 245
LCS³, Audio/Video patch panel chord cables

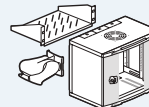

P. 244
Modular Panels cassettes for LCS³ fibre optic drawers

P. 245
LCS³ pigtails, case and quick-connect connectors



Movement Detectors and Door Phones



P. 251
Movement detectors



P. 251
Video door entry system



P17 Tempra Pro, Hypra and Plugs & Sockets

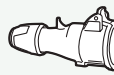

P. 258
P17 Tempra Pro sockets



P. 258-259
P17 Tempra Pro for refrigerated container



P. 260
Hypra industrial plugs and sockets

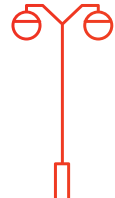
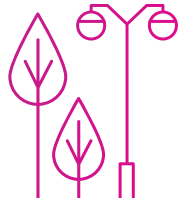
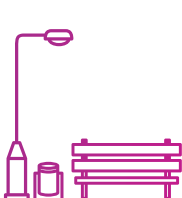

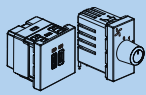

P. 197
Mechanisms
White - Electronic
Functions

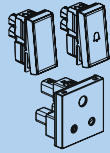

P. 197 - 198
Mechanisms Matt Black - Switches, Sockets & Dimmer and fan regulators, Hospitality Functions, Sockets 8 connectors and protectors and accessories, power unit , electronic function

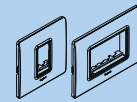

P. 198
Plates & Frames-
White, Matt Black, Gold,
Aluminium Champagne,
Rose Gold



P. 201-202
White plate, warm orange silver,
herb beige, urban bronze, orange
chrome with frame

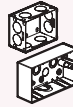

P. 203
Flush & surface
mounting boxes

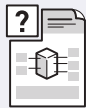

P. 215
Selection Chart:
Concrete Floor

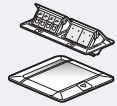

P. 218-219
Pop-up type
flush- mounting
boxes, Power & Data
desk grommets



P. 219
Flush Mounting
Power & data
module

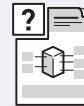

P. 222-223
Selection Chart:
Snap-On trunking



P. 226-227
Selection Chart :
DLP aluminium
Trunking system

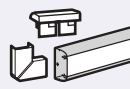

P. 228-229
DLP PVC Trunking
System, Trunking,
Mini-Trunking and
Accessories

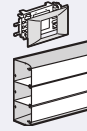

P. 230
DLP-S
PVC Trunking
system and Trunking
Accessories

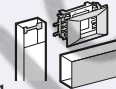

P. 230-231
DLP Aluminium
Adaptable Trunking
System, Aluminum
Snap-on columns

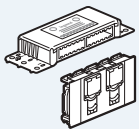

P. 236-240
LCS³,
cat. 6 Patch
Panels, RJ 45,
Cables and Cords

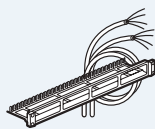

P. 240-241
LCS³,
cat. 5e Patch
panels, Cables
and Cords, RJ45

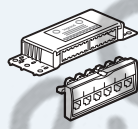

P. 241
LCS³,
cat. Splitter
sockets, adapters
and accessories

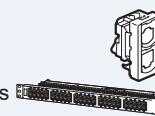

P. 243-244
LCS³, Audio/Video
Preterminated
sockets

P. 246-247
LCS³ High Density
and Very High
Density drawers
and cassettes

P. 247
LCS³
Preterminated fibre
optic and cable
solutions

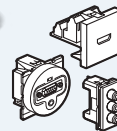

P. 249
9" fibre optic
drawers, LCS³
fibre optic blocks

P. 249
Patch chords



Intelligent EI

SMARTNESS THAT MAKES A DIFFERENCE

Our Intelligent EI is a fully interconnected electrical system that enables reliable delivery of energy to customers through real-time, automated control systems. An overlay of information-oriented software and services on top of the existing infrastructure provides more reasons and opportunities for customer participation to make informed decisions and better operational efficiency.

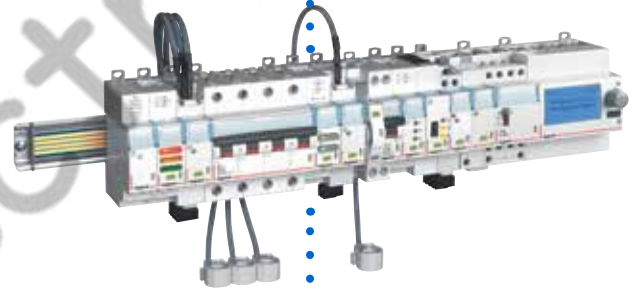

**PROGRAMMING
AND DISPLAY**



COMMUNICATION



MEASUREMENT



SIGNALLING



CONTROL



Scan to know more about the product.



SIGNALLING
AND CONTROL



CX³

A SMART PLATFORM FOR YOUR ENERGY MANAGEMENT NEEDS

The CX³ EMS energy management system allows the precise management and use of energy within a building. It allows full control of all activities and help supervises facility more effectively.



WEBSERVER



ACBs



MCCB'S



MEASURING UNIT



WATER



GAS



Scan to know more about the product.



3RD PARTY BMS/SCADA

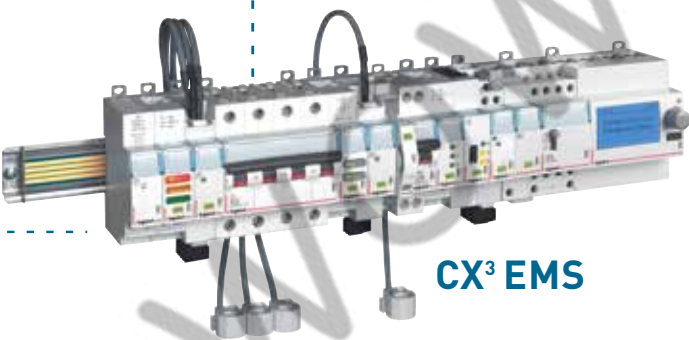

CX³ EMS



ENERGY
METER



ELECTRICITY

XL³ DO

FUTURE READY
ENCLOSURES DESIGNED
TO OUTPERFORM
ALL CONDITIONS

6300A
Integrated Switchboard Solutions



Scan to know more about
the product.

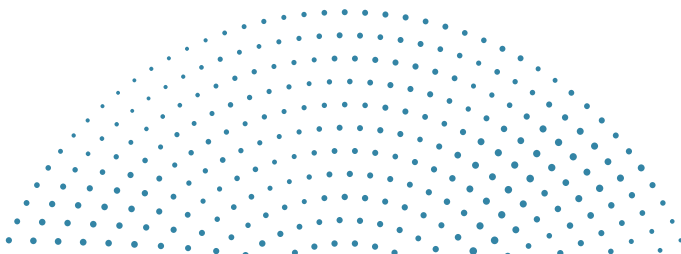

Advantages with XL3 DO:



Design verified assembly in accordance with IEC 61439, guarantees safe investment.



Internal arc withstand ensures additional personal safety.



Design Ambient of 50°C to withstand the harsh Indian conditions.



Available in IP43/54 configuration ensures further safety.



Be Connected and take control through communication capable products.



Sufficient cabling space with real front access foresees maintenance.



The wide choice of columns offers an unlimited number of XL3 DO enclosure configurations, so you can optimise and adapt your solutions to different types of environment.



Compact solution guarantees space saving.

AIR CIRCUIT BREAKERS

DMX³

EFFICIENT
PROTECTION
UP TO 6300 A



MP6 LSI/LSIg TOUCH SCREEN PROTECTION UNIT



LEDs INDICATING CORRECT
OPERATION, PRE-ALARM
AND ALARM FOR OVERLOAD
AND TEMPERATURE

SETTINGS LOCK

ON BUTTON

MINI USB
PORT FOR PC
CONNECTION

Innovative and user friendly touch screen tripping units



Scan to know more about
the product.

DMX³ Air Circuit Breakers



- Range – 630 A to 6300 A
- Three Optimum Frame Sizes
- Breaking Capacities of 50 kA, 65 kA & 100 kA
- Advanced Self Powered Electronic Protection Units
- Options for LSI and LSIG Trip Units
 - L : Ir – 0.4 to 1 In , tr – 5 to 30 sec
 - S : Isd – 1.5 to 10 Ir , tsd – 0.1 to 1 sec
 - I : Ii – 2 to 15 In
 - G : 0.2 to 1 In , tg – 0.1 to 1 sec
- Options of LCD and Touch Screen Multi Colour Displays
- Neutral Overload Protection – OFF-50 %-100 %
- Communication Ready
- In Built Temperature Protection
- Rotatable Terminals for Horizontal/Vertical Orientation
- Fast Operation
- Options to install various safety interlock
- Internal Battery for Trip Units
- Individual fault diagnosis
- Individual Fault Counter & Historical Trip Record
- Option to add 6 Programmable Digital Relay Contacts with Time Delay Changeover
- Option to Measure Current, Voltage, Frequency, Power, Energy, Power Factor and internal battery voltage
- Advanced Functions of Logical Selectivity, Reverse Power, Current Unbalance, Overvoltage, Undervoltage, Voltage Unbalance, Under Frequency, Over Frequency & Phase Reversal

Type and frame size	Rated Current (A)	3P			4P		
		Cat.Nos	MRP*/₹/Unit	Pack	Cat.Nos	MRP*/₹/Unit	Pack

Fixed Version

DMX ³ - N 2500, Icu 50 kA Frame - 1	630 A	0286 20	■	1	0286 30	■	1
	800 A	0286 21	■	1	0286 31	■	1
	1000 A	0286 22	■	1	0286 32	■	1
	1250 A	0286 23	■	1	0286 33	■	1
	1600 A	0286 24	■	1	0286 34	■	1
	2000 A	0286 25	■	1	0286 35	■	1
	2500 A	0286 26	■	1	0286 36	■	1
DMX ³ -N 4000 Icu 50 kA Frame - 2	3200 A	0286 27	■	1	0286 37	■	1
	4000 A	0286 28	■	1	0286 38	■	1
DMX ³ - H 2500, Icu 65 kA Frame - 1	630 A	0286 40	■	1	0286 50	■	1
	800 A	0286 41	■	1	0286 51	■	1
	1000 A	0286 42	■	1	0286 52	■	1
	1250 A	0286 43	■	1	0286 53	■	1
	1600 A	0286 44	■	1	0286 54	■	1
	2000 A	0286 45	■	1	0286 55	■	1
	2500 A	0286 46	■	1	0286 56	■	1
DMX ³ -H 4000 Icu 65 kA Frame - 2	3200 A	0286 47	■	1	0286 57	■	1
	4000 A	0286 48	■	1	0286 58	■	1
DMX ³ - L 2500, Icu 100 kA Frame - 2	630 A	0286 60	■	1	0286 70	■	1
	800 A	0286 61	■	1	0286 71	■	1
	1000 A	0286 62	■	1	0286 72	■	1
	1250 A	0286 63	■	1	0286 73	■	1
	1600 A	0286 64	■	1	0286 74	■	1
	2000 A	0286 65	■	1	0286 75	■	1
	2500 A	0286 66	■	1	0286 76	■	1
DMX ³ -L 4000 Icu 100 kA Frame - 2	3200 A	0286 67	■	1	0286 77	■	1
	4000 A	0286 68	■	1	0286 78	■	1
DMX ³ -L 6300 Icu 100 kA Frame - 3	5000 A	0289 50	■	1	0289 60	■	1
	6300 A	0289 51	■	1	0289 61	■	1

■ Price available on request.

* MRP - Maximum Retail Price Inclusive of all taxes including GST.

Bold Cat.Nos are products normally available with Legrand (India) Stockists. Cat.Nos that are not bold - delivery within 4 - 8 weeks from the date of order. Bold packing quantity is our mandatory packing. Orders to be placed by Legrand (India) Stockist in multiples of the same.

DMX³ Air Circuit Breakers

Type and frame size	Rated Current (A)	3P			4P		
		Cat.Nos	MRP*/₹/Unit	Pack	Cat.Nos	MRP*/₹/Unit	Pack

Draw - Out Version

DMX ³ - N 2500, Icu 50 kA Frame - 1	630 A	0287 20	■	1	0287 30	■	1
	800 A	0287 21	■	1	0287 31	■	1
	1000 A	0287 22	■	1	0287 32	■	1
	1250 A	0287 23	■	1	0287 33	■	1
	1600 A	0287 24	■	1	0287 34	■	1
	2000 A	0287 25	■	1	0287 35	■	1
	2500 A	0287 26	■	1	0287 36	■	1
DMX ³ -N 4000 Icu 50 kA Frame - 2	3200 A	0287 27	■	1	0287 37	■	1
	4000 A	0287 28	■	1	0287 38	■	1
DMX ³ - H 2500, Icu 65 kA Frame - 1	630 A	0287 40	■	1	0287 50	■	1
	800 A	0287 41	■	1	0287 51	■	1
	1000 A	0287 42	■	1	0287 52	■	1
	1250 A	0287 43	■	1	0287 53	■	1
	1600 A	0287 44	■	1	0287 54	■	1
	2000 A	0287 45	■	1	0287 55	■	1
	2500 A	0287 46	■	1	0287 56	■	1
DMX ³ -H 4000 Icu 65 kA Frame - 2	3200 A	0287 47	■	1	0287 57	■	1
	4000 A	0287 48	■	1	0287 58	■	1
DMX ³ - L 2500, Icu 100 kA Frame - 2	630 A	0287 60	■	1	0287 70	■	1
	800 A	0287 61	■	1	0287 71	■	1
	1000 A	0287 62	■	1	0287 72	■	1
	1250 A	0287 63	■	1	0287 73	■	1
	1600 A	0287 64	■	1	0287 74	■	1
	2000 A	0287 65	■	1	0287 75	■	1
	2500 A	0287 66	■	1	0287 76	■	1
DMX ³ -L 4000 Icu 100 kA Frame - 2	3200 A	0287 67	■	1	0287 77	■	1
	4000 A	0287 68	■	1	0287 78	■	1
DMX ³ -L 6300 Icu 100 kA Frame - 3	5000 A	0289 52	■	1	0289 62	■	1
	6300 A	0289 53	■	1	0289 63	■	1



0287 56

Switch Disconnecter (Trip Free Switches) from 1250 to 6300 A

Fixed Version

DMX ³ -I 2500 Frame - 1	1250 A	0286 83	■	1	0286 93	■	1
	1600 A	0286 84	■	1	0286 94	■	1
	2000 A	0286 85	■	1	0286 95	■	1
	2500 A	0286 86	■	1	0286 96	■	1
DMX ³ -I 4000 Frame - 2	3200 A	0286 87	■	1	0286 97	■	1
	4000 A	0286 88	■	1	0286 98	■	1
DMX ³ -I 6300 Frame - 3	6300 A	0289 70	■	1	0289 71	■	1



0286 96

Draw - Out Version

DMX ³ -I 2500 Frame - 1	1250 A	0287 83	■	1	0287 93	■	1
	1600 A	0287 84	■	1	0287 94	■	1
	2000 A	0287 85	■	1	0287 95	■	1
	2500 A	0287 86	■	1	0287 96	■	1
DMX ³ -I 4000 Frame - 2	3200 A	0287 87	■	1	0287 97	■	1
	4000 A	0287 88	■	1	0287 98	■	1
DMX ³ -I 6300 Frame - 3	6300 A	0289 77	■	1	0289 78	■	1



0287 96

* MRP - Maximum Retail Price Inclusive of all taxes including GST.
■ Price available on request.

Bold Cat.Nos are products normally available with Legrand (India) Stockists.
Cat.Nos that are not bold - delivery within 4 - 8 weeks from the date of order.
Bold packing quantity is our mandatory packing. Orders to be placed by Legrand (India) Stockist in multiples of the same.

DMX³

Electronic Protection Units

Cat.Nos	Description	MRP*/₹/Unit	Pack
---------	-------------	-------------	------

Electronic Protection Units MP4

0288 01	Electronic Protection Unit with LCD screen with Im, tm, lr, tr and li adjustments on the front	■	1
0288 02	Electronic Protection Unit with LCD screen with Im, tm, lr, tr, li, lg and tg adjustments on the front	■	1



0288 02

Electronic Protection Units MP6

0288 03	Electronic Protection Unit with Touch screen with Im, tm, lr, tr and li, adjustments on the front	■	1
0288 04	Electronic Protection Unit with Touch screen with Im, tm, lr, tr, li, lg and tg adjustments on the front	■	1



0288 03

Accessories for Electronic Protection Units

0288 10	External neutral CT for DMX ³ 6300	■	1
0288 11 ⁽¹⁾	External neutral CT	■	1

Type and frame size	3P			4P		
	Cat.Nos	MRP*/₹/Unit	Pack	Cat.Nos	MRP*/₹/Unit	Pack

Fixed Version

DMX ³ 2500, fixed version, frame - 1	0288 84	■	1	0288 85	■	1
	0288 82	■	1	0288 83	■	1
DMX ³ 4000, DMX ³ 6300 fixed version, frame - 2 & 3	0288 92	■	1	0288 93	■	1
DMX ³ 2500 draw-out version, Frame - 1	0288 96	■	1	0288 97	■	1
DMX ³ 4000, DMX ³ 6300 draw-out version, fram - 2 & 3	0288 94	■	1	0288 95	■	1
DMX ³ 2500, draw-out version, frame-1 suitable for Aluminium	0288 96A	■	1	0288 97A	■	1
DMX ³ 4000, DMX ³ 6300 draw-out version, frame - 2&3, suitable for Aluminium	0288 94A	■	1	0288 95A	■	1



0288 84



0288 82



0288 96

Spreaders

DMX ³ 2500, fixed version, frame - 1	0289 02	■	1	0288 87	■	1
	0288 88	■	1	0288 89	■	1
	0288 90	■	1	0288 91	■	1



0288 91

Equipment for conversion of a fixed device into draw-out device

Bases (cradle) for Draw-Out Device

DMX ³ /DMX ³ -I 2500, frame - 1	0289 02	■	1	0289 03	■	1
DMX ³ /DMX ³ -I 4000, frame - 2	0289 04	■	1	0289 05	■	1
DMX ³ /DMX ³ -I 6300, frame - 3	0289 13	■	1	0289 14	■	1

Transformation kit for Draw-Out Version

DMX ³ /DMX ³ -I 2500, frame - 1	0289 09	■	1	0289 10	■	1
DMX ³ /DMX ³ -I 4000, frame - 2	0289 11	■	1	0289 12	■	1
DMX ³ /DMX ³ -I 6300, frame - 3	0289 15	■	1	0289 16	■	1

* MRP - Maximum Retail Price inclusive of all taxes including GST.

■ Price available on request.

(1) Optional accessories to be ordered while ordering electronic protection unit and DMX³ air circuit breakers for factory assembly

Bold Cat.Nos are products normally available with Legrand (India) Stockists. Cat.Nos that are not bold - delivery within 4 - 8 weeks from the date of order. Bold packing quantity is our mandatory packing. Orders to be placed by Legrand (India) Stockist in multiples of the same.

DMX³ Auxiliaries and Accessories

Cat.Nos	Description	MRP* ₹ / Unit	Pack
---------	-------------	------------------	------

Control and signalling auxiliaries

Shunt trip

0288 48	24 V~/=	■	1
0288 49	48 V~/=	■	1
0288 50	110 V~/=	■	1
0288 51	230 V~/=	■	1
0288 52	415 V~	■	1



0288 51

Undervoltage Releases

0288 55	24 V~/=	■	1
0288 56	48 V~/=	■	1
0288 57	110 V~/=	■	1
0288 58	230 V~/=	■	1
0288 59	415 V~	■	1



0288 58

Undervoltage Releases with Delay

0288 62	110 V~/=	■	1
0288 63	230 V~/=	■	1

Motor operators

0288 34	24 V~/=	■	1
0288 35	48 V~/=	■	1
0288 36	110 V~/=	■	1
0288 37	230 V~/=	■	1
0288 38	415 V~	■	1



0288 37

Closing coils

0288 41	24 V~/=	■	1
0288 42	48 V~/=	■	1
0288 43	110 V~/=	■	1
0288 44	230 V~/=	■	1
0288 45	415 V~	■	1



0288 44

Locking

Key locking in "open" position

0288 31	Ronis lock (key included)	■	1
0288 29	Ronies key barrel	■	1
0288 30	Profalux lock (key included)	■	1
0288 28	2 hole support frame for Ronis locks	■	1

DMX³ Auxiliaries and Accessories

Cat.Nos	Description	MRP* ₹ / Unit	Pack
---------	-------------	------------------	------

Locking

Key locking in the draw-out position

0288 33	Ronis lock (key included)	■	1
0288 32	Profalux lock (key included)	■	1



0288 32
+
0288 33

Door locking

0288 20	Left-hand and right-hand side mounting	■	1
---------	--	---	---

Padlocks in "open" position

0288 21	Padlocking system for ACB	■	1
0288 24	Padlocking for button	■	1
0288 26	Padlocking system for shutters	■	1

Automation Control Unit

4226 81	Standard unit	■	1
4226 82	Advanced unit	■	1
4226 89▼	Communication module	■	1



4226 82

Equipment for supply invertors

0288 64	Interlock for DMX ³ 2500	■	1
0288 65	Interlock for DMX ³ 4000	■	1
0288 66	Interlock for DMX ³ 6300	■	1



0288 64

Cable interlock

0289 20	Type 1 (2600 mm)	■	1
0289 21	Type 2 (3000 mm)	■	1
0289 22	Type 3 (3600 mm)	■	1
0289 23	Type 4 (4000 mm)	■	1
0289 24	Type 5 (4600 mm)	■	1
0289 25	Type 6 (5600 mm)	■	1

Accessories

0288 25	Rating mis-insertion device	■	1
0288 23	Operations counter	■	1
0288 13	Inserted / test / Draw-out Contact	■	1
0288 14	Contact "ready to close" with charged springs	■	1
0288 15	Set of additional signalling contacts	■	1
0288 16	Signal Contact for Auxiliaries	■	1
0288 22	Door sealing IP 40	■	1
0288 79	Lifting plate	■	1

* MRP - Maximum Retail Price Inclusive of all taxes including GST.
■ Price available on request.
▼ For communication add 4226 82 + 4226 89

Bold Cat.Nos are products normally available with Legrand (India) Stockists. Cat.Nos that are not bold - delivery within 4 - 8 weeks from the date of order. Bold packing quantity is our mandatory packing. Orders to be placed by Legrand (India) Stockist in multiples of the same.

DMX

SP-2500

A SUPERIOR ACB IN
THE 630 A - 2500 A RANGE



OPTIMIZED



GENEROUS
CLEARANCES

SMART



ELECTRONIC RELEASES
OFFERING PRECISE
PROTECTION



IN - BUILT TEMPERATURE
PROTECTION

EFFICIENT



EASY INSTALLATION



EASY MAINTENANCE



Scan to know more about
the product.

DMX SP 2500 Air Circuit Breakers



- Range – 630 A to 2500 A
- Single Frame Size
- Options of Fixed and Drawout Versions
- Options of Manual & Electrical Versions
- Icu=Ics=Icw(1s)=50 kA
- Compact Dimensions
- Advanced Self Powered Electronic Protection Units
 - MP2 & MP4
- MP2 - Electronic PU with LSI/LSIg + Neutral O/L + Over Temperature Protection
- MP4 - Electronic PU with LSI/LSIg + Neutral O/L + Over Temperature Protection
 - + LCD Display with Current Metering + 10 Trip History + 10 Alarms + Logical Selectivity
- Options of LSI and LSIg Protections
 - L : I_r – 0.4 to 1 I_n, t_r – 5 to 30 sec
 - S : I_{sd} – 1.5 to 10 I_r, t_{sd} – 0.1 to 1 sec
 - I : I_{li} – 2 to 15 I_n
 - G : I_g – 0.2 to 1 I_n, t_g – 0.1 to 1 sec
- Neutral Overload Protection - OFF-50 %-100 %
- In Built Temperature Protection
- Rotatable Terminals for Horizontal/Vertical Orientation
- Fast Operation
- Options to install various safety interlock



6695 26



6695 31

Type and frame size	Rated Current (A)	3P			4P		
		Cat.Nos	MRP*/₹/Unit	Pack	Cat.Nos	MRP*/₹/Unit	Pack

Fixed Version

DMX SP 2500 Icu = 50 kA	630 A	6695 24	114708	1	6695 30	159776	1
	800 A	6695 25	114708	1	6695 31	159776	1
	1000 A	6695 26	122900	1	6695 32	172068	1
	1250 A	6695 27	145434	1	6695 33	200740	1
	1600 A	6695 28	168880	1	6695 34	221156	1
	2000 A	6695 29	202248	1	6695 35	272186	1
	2500 A	6695 76	256090	1	6695 77	297618	1

Drawout version

DMX SP 2500 Icu = 50 kA	630 A	6695 36	147478	1	6695 42	192542	1
	800 A	6695 37	147478	1	6695 43	192542	1
	1000 A	6695 38	155680	1	6695 44	204842	1
	1250 A	6695 39	178214	1	6695 45	233518	1
	1600 A	6695 40	201044	1	6695 46	253316	1
	2000 A	6695 41	249300	1	6695 47	296380	1
	2500 A	6695 78	290696	1	6695 79	346068	1

Switch Disconnectors / Trip Free Switches Fixed version

DMX SP 2500	630 A	6695 48	114708	1	6695 54	159776	1
	800 A	6695 49	114708	1	6695 55	159776	1
	1000 A	6695 50	122900	1	6695 56	172068	1
	1250 A	6695 51	145434	1	6695 57	200740	1
	1600 A	6695 52	168880	1	6695 58	221156	1
	2000 A	6695 53	202248	1	6695 59	265700	1
	2500 A	6695 80	256090	1	6695 81	297618	1

Drawout version

DMX SP 2500	630 A	6695 60	147478	1	6695 66	192542	1
	800 A	6695 61	147478	1	6695 67	192542	1
	1000 A	6695 62	155680	1	6695 68	204842	1
	1250 A	6695 63	178214	1	6695 69	233518	1
	1600 A	6695 64	201044	1	6695 70	253316	1
	2000 A	6695 65	249300	1	6695 71	296380	1
	2500 A	6695 82	290696	1	6695 83	346068	1

* MRP - Maximum Retail Price Inclusive of all taxes including GST.

Bold Cat.Nos are products normally available with Legrand (India) Stockists. Cat.Nos that are not bold - delivery within 4 - 8 weeks from the date of order. Bold packing quantity is our mandatory packing. Orders to be placed by Legrand (India) Stockist in multiples of the same.

DMX SP 2500

Electronic Protection Units

Cat.Nos	Description	MRP* ₹ / Unit	Pack
---------	-------------	------------------	------

Electronic Protection Units

0281 67	Electronic Protection Unit MP2 LSI	25426	1
0281 68	Electronic Protection Unit MP2 LSIG	31290	1
0281 65	Electronic Protection Unit MP4 LSI	30912	1
0281 66	Electronic Protection Unit MP4 LSIG	38640	1

Auxiliaries Accessories

Motor operator

0281 20	24 V~/=	36072	1
0281 21	48 V~/=	36072	1
0281 22	110-130 V~/=	36072	1
0281 23	220-250 V~/=	36072	1
0281 24	415-440 V~	36072	1

Closing coil

0281 26	24 V~/=	6078	1
0281 27	48 V~/=	6078	1
0281 28	110-130 V~/=	6078	1
0281 29	220-250 V~/=	6078	1
0281 30	415-440 V~	6078	1

Shunt release

0281 31	24 V~/=	6078	1
0281 32	48 V~/=	6078	1
0281 33	110-130 V~/=	6078	1
0281 34	220-250 V~/=	6078	1
0281 35	415-440 V~	6078	1

Undervoltage release

0281 36	24 V~/=	7820	1
0281 37	48 V~/=	7820	1
0281 38	110-130 V~/=	7820	1
0281 39	220-250 V~/=	7820	1
0281 40	415-440 V~	7820	1

Time Delay Module for Undervoltage release

0288 62	110 V~/=	■	1
0288 63	230 V~/=	■	1

Mechanical Accessories

Phase barriers / Insulated shields

6696 00	Fix Version 3P DMX SP	■	1
6696 01	Fix Version 4P DMX SP	■	1
6696 02	Draw-out Version 3P DMX SP	■	1
6696 03	Draw-out Version 4P DMX SP	■	1

■ Price available on request.

* MRP - Maximum Retail Price Inclusive of all taxes including GST.

DMX SP 2500

Auxiliaries Accessories

Cat.Nos	Description	MRP* ₹ / Unit	Pack
---------	-------------	------------------	------

Key lock

0281 78	Keylock in open position (1 lock 1 Ronis random) Frame 2500	5090	1
0281 79	Keylock in open position (1 lock 1 Ronis type "A") Frame 2500	5090	1
0281 80	Keylock in open position (1 lock 1 Ronis type "B") Frame 2500	5090	1
0281 81	Keylock in open position - Profalux DMX SP	5090	1
0281 82	Keylock ins./test/drawnout - Profalux DMX SP	5090	1
0281 83	Keylock ins./test/drawnout - Ronis DMX SP	5090	1
0281 84	Door lock for both right & left handle Frame 2500	5090	1
0281 87	Inserted/test/drawnout lock button	2348	1

Terminals

0288 84	Real terminals - flat connections with bars-3P	20298	1
0288 82	Real terminals - vertical connections with bars-4P	22552	1
0288 85	Real terminals - flat connections with bars-3P	26390	1
0288 83	Real terminals - vertical connections with bars-4P	30444	1
0288 96	Real terminals - vertical or horizontal connection with bars to be fixed onto plate-3P	12276	1
0288 97	Real terminals - vertical or horizontal connection with bars to be fixed onto plate-4P	16368	1

Additional Accessories

0281 88	Mechanical Counter	3914	1
0281 77	Padlock for Button	1560	1
6696 05	Enternal Neutral	7598	1
0281 73	Signalling Contact inserted-test-D/O	3064	1
0281 74	AUX Ready to close-charged springs	3126	1
0281 75	Module with 6 aux contacts	23468	1
0281 90	Mechanical Interlock two device	12548	1

Bold Cat.Nos are products normally available with Legrand (India) Stockists. Cat.Nos that are not bold - delivery within 4 - 8 weeks from the date of order. Bold packing quantity is our mandatory packing. Orders to be placed by Legrand (India) Stockist in multiples of the same.

DPX³

PRECISE PROTECTION
AND MEASUREMENT
UP TO 1600 A



TOTAL SELECTIVITY FOR OPTIMUM CONTINUITY OF SERVICE

DYNAMIC SELECTIVITY

Electronic DPX³ units have 2-position adjustment:

- Low for normal selectivity level
- High for high selectivity level

When electronic circuit breakers are set to High there is a slight tripping delay, enabling a high level of selectivity to be obtained, even for the highest short-circuit currents.

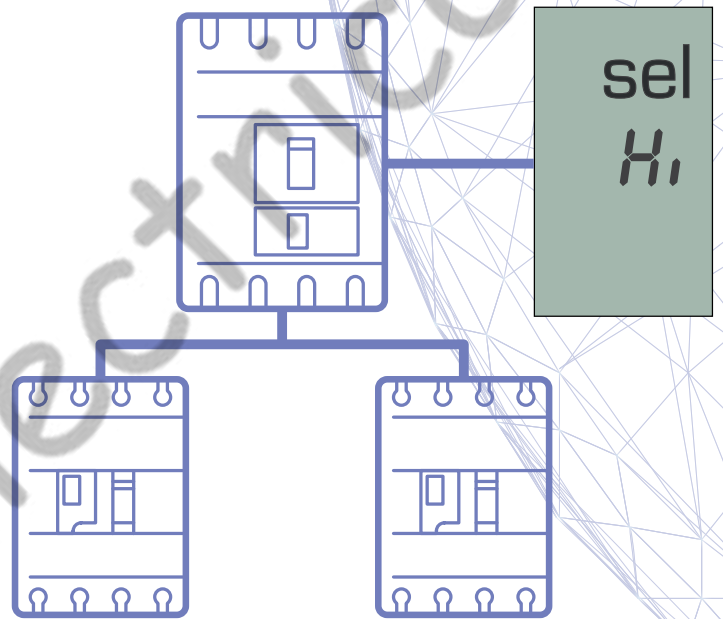

DPX³ 160



DPX³ 250



DPX³ 630



DPX³ 1600



Scan to know more about
the product.



NEW FUNCTIONS
TO SIMPLIFY USE

Integrated measurement From 40 to 1600 A

The measurement data can also be viewed remotely on a PC equipped with supervision software, via a communication interface.

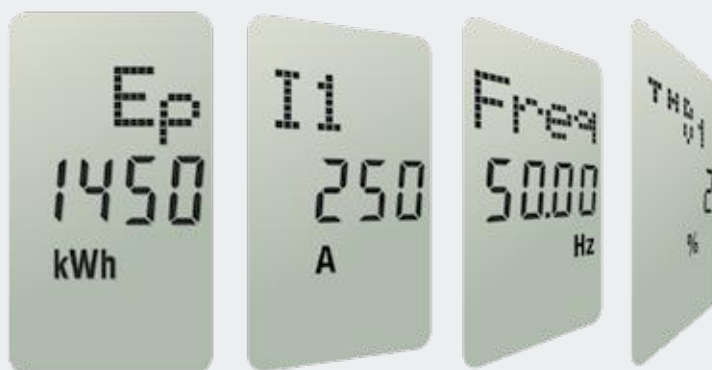

DRX™ MCCB

Type and frame size	Rated Current (A)	Poles	Cat.Nos	MRP* ₹ / Unit	Pack
---------------------	-------------------	-------	---------	---------------	------

DRX MCCBs

DRX 100	63 A	3 Pole	0270 39	3512	1/12
Icu = 10 kA	75 A	3 Pole	0270 07	3512	1/12
	100 A	3 Pole	0270 08	3512	1/12
	63 A	4 Pole	0270 29	5056	1/12
	75 A	4 Pole	0270 17	5056	1/12
	100 A	4 Pole	0270 18	5056	1/12

Description	Cat.Nos	MRP* ₹ / Unit	Pack
-------------	---------	---------------	------

DIN rail adaptor

DRX 100	0271 87	480	1
---------	---------	-----	---

Rotary handles - Direct

DRX 100	6687 70	1206	1
---------	---------	------	---

Rotary handles - vary-depth

DRX 100	6687 71	1850	1
---------	---------	------	---

Padlocking support for operating handle

DRX 100	0271 80	166	1
---------	---------	-----	---

Connection accessories

Set of 2 shields for 3 pole	0271 81	118	1
-----------------------------	---------	-----	---

Sealable terminal shields (moulded shrouds)

For DRX 100 - 3 pole	0271 83	1570	1
For DRX 100 - 4 pole	0271 84	1570	1

Cage terminals

For DRX 100 - 3 pole	0271 71	322	1
For DRX 100 - 4 pole	0271 73	315	1

Electrical accessories

Block with 1 auxiliary (1 AUX)	0271 40	1050	1
Block with 1 alarm (1 AL)	0271 41	1050	1
Block with 1 auxiliary + 1 alarm (1 AUX + 1 AL)	0271 42	1838	1

Current shunt coils

200/277 V~ and =	0271 54	2268	1
380/480 V~ and =	0271 55	2268	1

Undervoltage release coils

200/240 V~	0271 64	3150	1
380/415 V~	0271 65	3150	1

DRX spreader links

3 Links set for TP	6250 10	264	1
4 Links set for FP	6250 11	374	1

Metal one way enclosures for MCCB

Cat.Nos	Description	No. of modules	MRP* ₹ / Unit	Pack
5078 05	DRX 100 MCCB enclosure-TP	3	2774	1
5078 06	DRX 100 MCCB enclosure-FP	3	2616	1

* MRP - Maximum Retail Price Inclusive of all taxes including GST.

BUSBAR TRUNKING SYSTEM

FOR INDUSTRIAL, COMMERCIAL, RESIDENTIAL AND SERVICE SECTOR BUILDINGS

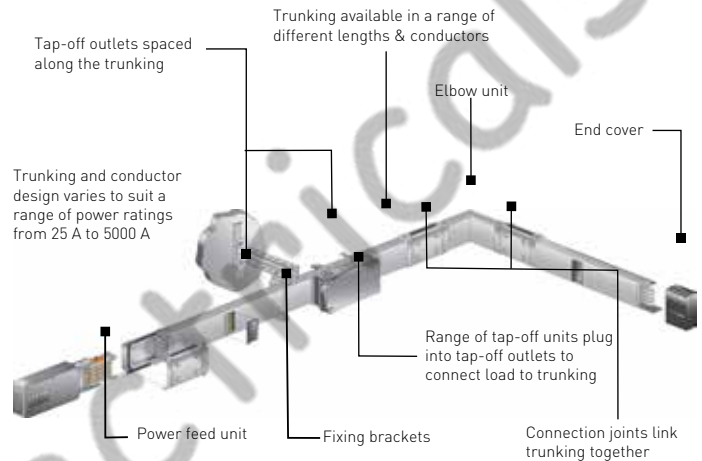

Exclusive features

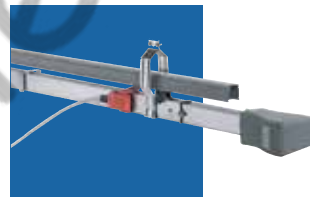

Low Power (25 A, 40 A, 63 A)

- Lighting busway
- 2, 4 & 6 pole
- IP 55 protection
- Tap off units at each 0.5 mt interval
- Copper busbars

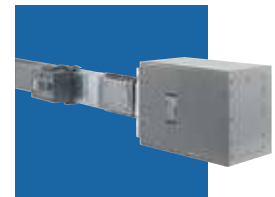

Medium Power (63 A - 1000 A)

- Riser mains application
- IP 40, IP 52, IP 55 protection
- Tap off units at each 1 mt interval
- Aluminium & copper busbars



Cast Resin Busbar (630 A - 6300 A)

- Fully insulated with epoxy resin
- IP68 suited for outdoor
- Industrial plants, Petrochemical plants, Chemical plants in areas with risk of flooding.

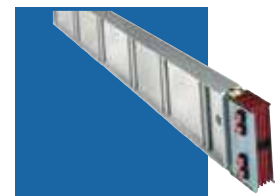

Super Compact (630 A - 6300 A)

- Sandwich type construction
- IP 65 protection
- Tap off boxes at each 1 mt interval
- Aluminium & copper busbars



Scan to know more about the product.

Bold Cat.Nos are products normally available with Legrand (India) Stockists. Cat.Nos that are not bold - delivery within 4 - 8 weeks from the date of order. Bold packing quantity is our mandatory packing. Orders to be placed by Legrand (India) Stockist in multiples of the same.

DPX³ MCCB

DPX³ MCCB with Thermal Magnetic Protection Unit

- Range: 16A – 1250A, Ics=100%Icu, Four Optimum Frames
 - Thermal Adjustable – 0.8 to 1In, Magnetic Adjustable** – 5 to 10In
 - Breaking Capacity# – 16kA, 25kA, 36kA, 50kA, 70kA & 100kA
 - Option for In built or add on module for Earth Leakage Protection##
 - Adjustable sensitivity: 0.03 - 0.3 - 1 - 3 A
 - Adjustable tripping: 0 - 0.3 - 1 - 3s
 - Suitable for Isolation
- ** Fixed at 10In for DPX³ 160
 # Refer Catalogue for frame wise data
 ## For DPX³ 160, DPX³ 250 and DPX³ 630 Only

Category	Type	Rated Current (A)	3P			4P		
			Cat.Nos	MRP*/₹/Unit	Pack	Cat.Nos	MRP*/₹/Unit	Pack

Thermal Magnetic : O/L & S/C protection

16 KA	DPX ³ 160	16	4200 00	7332	1	4200 10	9772	1
		25	4200 01	7332	1	4200 11	9772	1
		40	4200 02	7332	1	4200 12	9772	1
		63	4200 03	7332	1	4200 13	9772	1
		80	4200 04	7332	1	4200 14	9772	1
		100	4200 05	7332	1	4200 15	9772	1
		125	4200 06	7932	1	4200 16	9834	1
		160	4200 07	10228	1	4200 17	12876	1
25 KA	DPX ³ 160	16	4200 40	8570	1	4200 50	11912	1
		25	4200 41	8570	1	4200 51	11912	1
		40	4200 42	8570	1	4200 52	11912	1
		63	4200 43	8570	1	4200 53	11912	1
		80	4200 44	8570	1	4200 54	11912	1
		100	4200 45	8570	1	4200 55	11912	1
		125	4200 46	12400	1	4200 56	15046	1
		160	4200 47	16112	1	4200 57	19158	1
	DPX ³ 250	200	4202 08	22264	1	4202 18	26902	1
		250	4202 09	25810	1	4202 19	34778	1
36 KA	DPX ³ 160	16	4200 80	10862	1	4200 90	13552	1
		25	4200 81	10862	1	4200 91	13552	1
		40	4200 82	10862	1	4200 92	13552	1
		63	4200 83	10862	1	4200 93	13552	1
		80	4200 84	10862	1	4200 94	13552	1
		100	4200 85	10862	1	4200 95	13552	1
		125	4200 86	12738	1	4200 96	16616	1
		160	4200 87	16410	1	4200 97	19312	1
	DPX ³ 250	200	4202 38	28060	1	4202 48	35478	1
		250	4202 39	31138	1	4202 49	37994	1
	DPX ³ 630	320	4220 01	37418	1	4220 06	42498	1
		400	4220 02	37418	1	4220 07	43428	1
		500	4220 03	45028	1	4220 08	53558	1
		630	4220 04	45028	1	4220 09	54926	1
	DPX ³ 1600	800	4222 52	68702	1	4222 57	77294	1
		1000	4222 53	89672	1	4222 58	113364	1
		1250	4222 54	128128	1	4222 59	136378	1

■ Price available on request.

* MRP - Maximum Retail Price Inclusive of all taxes including GST.

Bold Cat.Nos are products normally available with Legrand (India) Stockists. Cat.Nos that are not bold - delivery within 4 - 8 weeks from the date of order. Bold packing quantity is our mandatory packing. Orders to be placed by Legrand (India) Stockist in multiples of the same.

DPX³ MCCB

DPX³ MCCB with Thermal Magnetic Protection Unit

Category	Type	Rated Current (A)	3P			4P		
			Cat.Nos	MRP*/₹/Unit	Pack	Cat.Nos	MRP*/₹/Unit	Pack
Thermal Magnetic : O/L & S/C protection								
50 KA	DPX ³ 160	16	4201 20	14468	1	4201 30	18226	1
		25	4201 21	14468	1	4201 31	18226	1
		40	4201 22	14468	1	4201 32	18226	1
		63	4201 23	14468	1	4201 33	18226	1
		80	4201 24	14468	1	4201 34	18226	1
		100	4201 25	14468	1	4201 35	18226	1
		125	4201 26	18958	1	4201 36	21844	1
		160	4201 27	21338	1	4201 37	24824	1
	DPX ³ 250	200	4202 68	33996	1	4202 78	42952	1
		250	4202 69	35894	1	4202 79	44672	1
	DPX ³ 630	320	4220 15	40626	1	4220 20	49514	1
		400	4220 16	41500	1	4220 21	49514	1
		500	4220 17	51376	1	4220 22	64880	1
		630	4220 18	51376	1	4220 23	66522	1
	DPX ³ 1600	800	4222 64	75642	1	4222 69	88792	1
		1000	4222 65	117992	1	4222 70	133198	1
		1250	4222 66	173338	1	4222 71	177596	1
	70 KA	DPX ³ 250	100	4206 05	29788	1	4206 15	32880
160			4206 07	37216	1	4206 17	46274	1
200			4206 08	45824	1	4206 18	56386	1
250			4206 09	48696	1	4206 19	58698	1
DPX ³ 630		320	4220 29	47526	1	4220 34	58860	1
		400	4220 30	47536	1	4220 35	58860	1
		500	4220 31	61994	1	4220 36	79862	1
		630	4220 32	65152	1	4220 37	79862	1
DPX ³ 1600		800	4222 76	122678	1	4222 81	142224	1
		1000	4222 77	185774	1	4222 82	263034	1
		1250	4222 78	190316	1	4222 83	303308	1

* MRP - Maximum Retail Price Inclusive of all taxes including GST.
 ■ Price available on request.

Bold Cat.Nos are products normally available with Legrand (India) Stockists. Cat.Nos that are not bold - delivery within 4 - 8 weeks from the date of order. Bold packing quantity is our mandatory packing. Orders to be placed by Legrand (India) Stockist in multiples of the same.

DPX³ MCCB

DPX³ MCCB with Thermal Magnetic Protection Unit

Category	Type	Rated Current (A)	3P			4P				
			Cat.Nos	MRP*/₹/Unit	Pack	Cat.Nos	MRP*/₹/Unit	Pack		
Thermal Magnetic + Electronic earth leakage module										
16 KA	DPX ³ 160	16	-	-	-	4200 30	32992	1		
		25	-	-	-	4200 31	32992	1		
		40	-	-	-	4200 32	32992	1		
		63	-	-	-	4200 33	32992	1		
		80	-	-	-	4200 34	32992	1		
		100	-	-	-	4200 35	32992	1		
		125	-	-	-	4200 36	34800	1		
		160	-	-	-	4200 37	44154	1		
25 KA	DPX ³ 160	16	-	-	-	4200 70	41772	1		
		25	-	-	-	4200 71	41772	1		
		40	-	-	-	4200 72	41772	1		
		63	-	-	-	4200 73	41772	1		
		80	-	-	-	4200 74	41772	1		
		100	-	-	-	4200 75	41772	1		
		125	-	-	-	4200 76	41788	1		
		160	-	-	-	4200 77	49330	1		
	DPX ³ 250	100	-	-	-	4202 25	50358	1		
		160	-	-	-	4202 27	52938	1		
		200	-	-	-	4202 28	54986	1		
		250	-	-	-	4202 29	58800	1		
		36 KA	DPX ³ 160	16	-	-	-	4201 10	50810	1
				25	-	-	-	4201 11	50810	1
40	-			-	-	4201 12	50810	1		
63	-			-	-	4201 13	50810	1		
80	-			-	-	4201 14	50810	1		
100	-			-	-	4201 15	50810	1		
125	-			-	-	4201 16	51084	1		
160	-			-	-	4201 17	60762	1		
DPX ³ 250	100	-	-	-	4202 55	52570	1			
	160	-	-	-	4202 57	61232	1			
	200	-	-	-	4202 58	64222	1			
	250	-	-	-	4202 59	68676	1			
	50 KA	DPX ³ 160	16	-	-	-	4201 50	58836	1	
			25	-	-	-	4201 51	58836	1	
40			-	-	-	4201 52	58836	1		
63			-	-	-	4201 53	58836	1		
80			-	-	-	4201 54	58836	1		
100			-	-	-	4201 55	58836	1		
125			-	-	-	4201 56	62690	1		
160			-	-	-	4201 57	67094	1		
DPX ³ 250		100	-	-	-	4202 85	63086	1		
		160	-	-	-	4202 87	73020	1		
	200	-	-	-	4202 88	76938	1			
	250	-	-	-	4202 89	81744	1			

■ Price available on request.

* MRP - Maximum Retail Price Inclusive of all taxes including GST.

Bold Cat.Nos are products normally available with Legrand (India) Stockists. Cat.Nos that are not bold - delivery within 4 - 8 weeks from the date of order. Bold packing quantity is our mandatory packing. Orders to be placed by Legrand (India) Stockist in multiples of the same.

DPX³ MCCB

DPX³ MCCB with Electronic S2* (LSI)* Protection Unit

- Range: 40A – 1600A, Ics=100%Icu, Three Optimum Frames
- Protection against overloads:
 - Ir adjustable from 0.4 to 1 x In
 - tr adjustable from 3 to 30s#
- Protection against short circuits:
 - I_{sd} adjustable from 1.5 to 10 x Ir
 - t_{sd} adjustable from 0 to 0.5s
- Inbuilt Instantaneous Protection:
 - Ii# – Fixed
- Option for In built or add on module for Earth Leakage Protection##
 - Adjustable sensitivity: 0.03 - 0.3 - 1 - 3 A
 - Adjustable tripping: 0 - 0.3 - 1 - 3s
- Breaking Capacity# – 25kA, 36kA, 50kA, 70kA & 100kA
- In built Display for Current Metering with accuracy of class 1
- Internal Battery with battery measure function
- Communication Ready via COMM Port
- Logical Selectivity Ready (Zone Selective Interlocking)
- Dynamic Selectivity as per Selectivity Charts
- In Built USB Port for Software Diagnosis
- Suitable for Isolation

Category	Type	Rated Current (A)	3P			4P		
			Cat.Nos	MRP*/₹/Unit	Pack	Cat.Nos	MRP*/₹/Unit	Pack

Electronic S2

25 KA	DPX ³ 250	40	4203 02	23752	1	4203 12	31186	1
		100	4203 05	23752	1	4203 15	31186	1
		160	4203 07	30774	1	4203 17	36804	1
		250	4203 09	40130	1	4203 19	49750	1
36 KA	DPX ³ 250	40	4203 32	25820	1	4203 42	31822	1
		100	4203 35	25820	1	4203 45	31822	1
		160	4203 37	32354	1	4203 47	43176	1
		250	4203 39	43348	1	4203 49	49880	1
	DPX ³ 630	320	4220 57	47680	1	4220 62	59518	1
		400	4220 58	47680	1	4220 63	58272	1
		500	4220 59	53352	1	4220 64	71562	1
		630	4220 60	54468	1	4220 65	73068	1
DPX ³ 1600	800	4223 00	91186	1	4223 06	112604	1	
	1000	4223 01	139622	1	4223 07	206026	1	
	1250	4223 02	168242	1	4223 08	250594	1	
	1600	4223 03	208210	1	4223 09	279668	1	
50 KA	DPX ³ 250	40	4203 62	30692	1	4203 72	40904	1
		100	4203 65	30692	1	4203 75	40240	1
		160	4203 67	37062	1	4203 77	44252	1
		250	4203 69	49454	1	4203 79	59858	1
	DPX ³ 630	320	4220 67	54140	1	4220 72	69050	1
		400	4220 68	54140	1	4220 73	69050	1
		500	4220 69	63260	1	4220 74	79078	1
		630	4220 70	63260	1	4220 75	79078	1
	DPX ³ 1600	800	4223 12	107438	1	4223 18	144874	1
		1000	4223 13	149434	1	4223 19	208268	1
		1250	4223 14	181332	1	4223 20	264316	1
		1600	4223 15	253956	1	4223 21	298968	1

* MRP - Maximum Retail Price Inclusive of all taxes including GST.
 ■ Price available on request.

Bold Cat.Nos are products normally available with Legrand (India) Stockists. Cat.Nos that are not bold - delivery within 4 - 8 weeks from the date of order. Bold packing quantity is our mandatory packing. Orders to be placed by Legrand (India) Stockist in multiples of the same.

DPX³ MCCB

DPX³ MCCB with Electronic S2[®] (LSI)[®] Protection Unit

Category	Type	Rated Current (A)	3P			4P		
			Cat.Nos	MRP*/₹/Unit	Pack	Cat.Nos	MRP*/₹/Unit	Pack

Electronic S2

70 KA	DPX ³ 250	40	4206 35	38820	1	4206 45	51356	1
		100	4206 37	39210	1	4206 47	51356	1
		160	4206 38	51350	1	4206 48	58990	1
		250	4206 39	58628	1	4206 49	75664	1
	DPX ³ 630	320	4220 77	68640	1	4220 82	88602	1
		400	4220 78	68640	1	4220 83	88602	1
		500	4220 79	78098	1	4220 84	99596	1
		630	4220 80	78098	1	4220 85	99596	1
	DPX ³ 1600	800	4223 24	140170	1	4223 30	177384	1
		1000	4223 25	196424	1	4223 31	280334	1
		1250	4223 26	235228	1	4223 32	327052	1
		1600	4223 27	316214	1	4223 33	389332	1

Electronic S2 + Electronic earth leakage module

25 kA	DPX ³ 250	40	-	-	-	4203 22	71250	1
		100	-	-	-	4203 25	70902	1
		160	-	-	-	4203 27	76058	1
		250	-	-	-	4203 29	89442	1
36 kA	DPX ³ 250	40	-	-	-	4203 52	74060	1
		100	-	-	-	4203 55	74060	1
		160	-	-	-	4203 57	81502	1
		250	-	-	-	4203 59	95256	1
50 kA	DPX ³ 250	40	-	-	-	4203 82	82506	1
		100	-	-	-	4203 85	82506	1
		160	-	-	-	4203 87	89214	1
		250	-	-	-	4203 89	103912	1
70 kA	DPX ³ 250	40	-	-	-	4206 55	104184	1
		100	-	-	-	4206 57	104184	1
		160	-	-	-	4206 58	117732	1
		250	-	-	-	4206 59	161274	1

■ Price available on request.

* MRP - Maximum Retail Price Inclusive of all taxes including GST.

Bold Cat.Nos are products normally available with Legrand (India) Stockists. Cat.Nos that are not bold - delivery within 4 - 8 weeks from the date of order. Bold packing quantity is our mandatory packing. Orders to be placed by Legrand (India) Stockist in multiples of the same.

DPX³ MCCB

DPX³ MCCB with Electronic Sg (LSIg) Protection Unit

- Range: 40A – 1600A, Ics=100%Icu, Three Optimum Frames
- Protection against Overloads:
 - Ir adjustable from 0.4 to 1 x In
 - tr adjustable from 3 to 30s#
- Protection against Short Circuits:
 - Isd adjustable from 1.5 to 10 x Ir
 - tsd adjustable from 0 to 0.5s
- Inbuilt Instantaneous Protection:
 - li# – Fixed
- Protection against Ground Fault:
 - Ig adjustable from 0.2 to 1 In & OFF
 - tg adjustable from 0.1 to 1s
- Breaking Capacity#– 25kA, 36kA, 50kA, 70kA & 100kA
- In built Display for Current Metering with high accuracy of class 1
- Internal Battery with battery measure function
- Communication Ready via COMM Port
- Logical Selectivity Ready (Zone Selective Interlocking)
- Dynamic Selectivity as per Selectivity Charts
- In Built USB Port for Software Diagnosis
- Switchable Thermal Memory
- Suitable for Isolation

Category	Type	Rated Current (A)	3P			4P		
			Cat.Nos	MRP*/₹/Unit	Pack	Cat.Nos	MRP*/₹/Unit	Pack

Electronic Sg

25 KA	DPX ³ 250	40	4205 02	42710	1	4205 12	47808	1
		100	4205 05	42710	1	4205 15	47808	1
		160	4205 07	47520	1	4205 17	52686	1
		250	4205 09	52534	1	4205 19	61470	1
36 KA	DPX ³ 250	40	4205 22	45228	1	4205 32	50952	1
		100	4205 25	45228	1	4205 35	50952	1
		160	4205 27	49938	1	4205 37	52968	1
		250	4205 29	51286	1	4205 39	54320	1
	DPX ³ 630	320	4221 37	62498	1	4221 42	67754	1
		400	4221 38	62498	1	4221 43	67754	1
		500	4221 39	64886	1	4221 44	78080	1
		630	4221 40	64886	1	4221 45	78080	1
	DPX ³ 1600	800	4223 96	134754	1	4224 02	162446	1
		1000	4223 97	179062	1	4224 03	235610	1
		1250	4223 98	201212	1	4224 04	280594	1
		1600	4223 99	209212	1	4224 05	316454	1
50 KA	DPX ³ 250	40	4205 42	46584	1	4205 52	51486	1
		100	4205 45	46584	1	4205 55	51486	1
		160	4205 47	51264	1	4205 57	56078	1
		250	4205 49	52600	1	4205 59	65700	1
	DPX ³ 630	320	4221 47	60950	1	4221 52	72542	1
		400	4221 48	61200	1	4221 53	72542	1
		500	4221 49	69438	1	4221 54	87570	1
		630	4221 50	69438	1	4221 55	87570	1
	DPX ³ 1600	800	4224 08	144290	1	4224 14	161042	1
		1000	4224 09	193766	1	4224 15	245604	1
		1250	4224 10	214086	1	4224 16	276724	1
		1600	4224 11	228420	1	4224 17	325162	1

* MRP - Maximum Retail Price Inclusive of all taxes including GST.
 ■ Price available on request.

Bold Cat.Nos are products normally available with Legrand (India) Stockists. Cat.Nos that are not bold - delivery within 4 - 8 weeks from the date of order. Bold packing quantity is our mandatory packing. Orders to be placed by Legrand (India) Stockist in multiples of the same.

DPX³ MCCB

DPX³ MCCB with Electronic Sg (LSIg) Protection Unit

Category	Type	Rated Current (A)	3P			4P		
			Cat.Nos	MRP*/₹/Unit	Pack	Cat.Nos	MRP*/₹/Unit	Pack
70 kA	DPX ³ 250	40	4206 92	48958	1	4207 02	55490	1
		100	4206 95	48958	1	4207 05	55490	1
		160	4206 97	57236	1	4207 07	63994	1
		250	4206 99	58618	1	4207 09	67348	1
	DPX ³ 630	320	4221 57	74196	1	4221 62	91544	1
		400	4221 58	74196	1	4221 63	91544	1
		500	4221 59	85428	1	4221 64	116252	1
		630	4221 60	85428	1	4221 65	116252	1
	DPX ³ 1600	800	4224 20	146840	1	4224 26	177088	1
		1000	4224 21	205248	1	4224 27	317530	1
		1250	4224 22	285936	1	4224 28	367590	1
		1600	4224 23	386100	1	4224 29	433340	1

DPX³ MCCB

DPX³ MCCB with Electronic S2^{*} (LSI)^{*} & Energy Metering Protection Unit

- Range: 40A – 1600A, Ics=100%Icu, Three Optimum Frames
- Protection against overloads:
 - Ir adjustable from 0.4 to 1 x In
 - tr adjustable from 3 to 30s#
- Protection against short circuits:
 - Isd adjustable from 1.5 to 10 x Ir
 - tsd adjustable from 0 to 0.5s
- Inbuilt Instantaneous Protection:
 - li# – Fixed
- Option for In built or add on module for Earth Leakage Protection##
 - Adjustable sensitivity: 0.03 - 0.3 - 1 - 3 A
 - Adjustable tripping: 0 - 0.3 - 1 - 3s
- Breaking Capacity# – 25kA, 36kA, 50kA, 70kA & 100kA
- Integrated energy metering with accuracy class 2
- Measure for currents, voltage, frequency, power, energy and harmonics
- Internal Battery with battery measure function
- Communication Ready via COMM Port
- Logical Selectivity Ready (Zone Selective Interlocking)
- Dynamic Selectivity as per Selectivity Charts
- In Built USB Port for Software Diagnosis
- Suitable for Isolation

Category	Type	Rated Current (A)	3P			4P		
			Cat.Nos	MRP*/₹/Unit	Pack	Cat.Nos	MRP*/₹/Unit	Pack
25 KA	DPX ³ 250	40	4204 02	46084	1	4204 12	52754	1
		100	4204 05	46084	1	4204 15	52772	1
		160	4204 07	49970	1	4204 17	57202	1
		250	4204 09	54106	1	4204 19	61692	1
36 KA	DPX ³ 250	40	4204 32	49284	1	4204 42	53534	1
		100	4204 35	49284	1	4204 45	53534	1
		160	4204 37	53738	1	4204 47	60076	1
		250	4204 39	58066	1	4204 49	67592	1
	DPX ³ 630	320	4220 97	64920	1	4221 02	76972	1
		400	4220 98	64920	1	4221 03	76972	1
		500	4220 99	70434	1	4221 04	86576	1
		630	4221 00	70434	1	4221 05	86576	1

■ Price available on request.

* MRP - Maximum Retail Price Inclusive of all taxes including GST.

Bold Cat.Nos are products normally available with Legrand (India) Stockists. Cat.Nos that are not bold - delivery within 4 - 8 weeks from the date of order. **Bold packing quantity** is our mandatory packing. Orders to be placed by Legrand (India) Stockist in multiples of the same.

DPX³ MCCB
DPX³ MCCB with Electronic S2[#] (LSI)[#] & Energy Metering Protection Unit

Category	Type	Rated Current (A)	3P			4P		
			Cat.Nos	MRP*/₹/Unit	Pack	Cat.Nos	MRP*/₹/Unit	Pack

Electronic S2 + Energy metering

36 KA	DPX ³ 1600	800	4223 48	113846	1	4223 54	127786	1
		1000	4223 49	159808	1	4223 55	224034	1
		1250	4223 50	187518	1	4223 56	253902	1
		1600	4223 51	205612	1	4223 57	280452	1
50 KA	DPX ³ 250	40	4204 62	55520	1	4204 72	60106	1
		100	4204 65	55520	1	4204 75	60106	1
		160	4204 67	60982	1	4204 77	66078	1
		250	4204 69	64478	1	4204 79	74450	1
	DPX ³ 630	320	4221 07	68854	1	4221 12	81930	1
		400	4221 08	68854	1	4221 13	81930	1
		500	4221 09	83582	1	4221 14	93408	1
		630	4221 10	83582	1	4221 15	93408	1
DPX ³ 1600	800	4223 60	120142	1	4223 66	148190	1	
	1000	4223 61	151016	1	4223 67	214074	1	
	1250	4223 62	180882	1	4223 68	267616	1	
	1600	4223 63	224034	1	4223 69	307836	1	
70 KA	DPX ³ 250	40	4206 65	58314	1	4206 75	64536	1
		100	4206 67	58314	1	4206 77	64536	1
		160	4206 68	69694	1	4206 78	74026	1
		250	4206 69	69814	1	4206 79	101534	1
	DPX ³ 630	320	4221 17	82678	1	4221 22	97126	1
		400	4221 18	82678	1	4221 23	96150	1
		500	4221 19	87830	1	4221 24	106966	1
		630	4221 20	87830	1	4221 25	105886	1
DPX ³ 1600	800	4223 72	137738	1	4223 78	170922	1	
	1000	4223 73	185698	1	4223 79	257224	1	
	1250	4223 74	220714	1	4223 80	297050	1	
	1600	4223 75	290410	1	4223 81	366746	1	

Electronic S2 + Energy Metering + Electronic earth leakage module

25 KA	DPX ³ 250	40	-	-	-	4204 22	100746	1
		100	-	-	-	4204 25	99770	1
		160	-	-	-	4204 27	106078	1
		250	-	-	-	4204 29	119478	1
36 KA	DPX ³ 250	40	-	-	-	4204 52	102042	1
		100	-	-	-	4204 55	99260	1
		160	-	-	-	4204 57	106940	1
		250	-	-	-	4204 59	118178	1
50 KA	DPX ³ 250	40	-	-	-	4204 82	106038	1
		100	-	-	-	4204 85	109068	1
		160	-	-	-	4204 87	116076	1
		250	-	-	-	4204 89	130548	1
70 KA	DPX ³ 250	40	-	-	-	4206 85	99048	1
		100	-	-	-	4206 87	99048	1
		160	-	-	-	4206 88	108820	1
		250	-	-	-	4206 89	138606	1

* MRP - Maximum Retail Price Inclusive of all taxes including GST.
 # Price available on request.

Bold Cat.Nos are products normally available with Legrand (India) Stockists. Cat.Nos that are not bold - delivery within 4 - 8 weeks from the date of order. Bold packing quantity is our mandatory packing. Orders to be placed by Legrand (India) Stockist in multiples of the same.

DPX³ MCCB

DPX³ MCCB with Electronic Sg (LSIg) & Energy Metering Protection Unit

- Range: 250A – 1600A, Ics=100%Icu, Two Optimum Frames
- Protection against Overloads:
 - Ir adjustable from 0.4 to 1 x In
 - tr adjustable from 3 to 30s
- Protection against Short Circuits:
 - Isd adjustable from 1.5 to 10 x Ir
 - tsd adjustable from 0 to 0.5s
- Inbuilt Instantaneous Protection:
 - li – Fixed
- Protection against Ground Fault:
 - Ig adjustable from 0.2 to 1 In & OFF
 - tg adjustable from 0.1 to 1s
- Breaking Capacity – 36kA, 50kA, 70kA & 100kA
- Integrated energy metering with accuracy class 2
- Measure for currents, voltage, frequency, power, energy and harmonics
- Internal Battery with battery measure function
- Communication Ready via COMM Port
- Logical Selectivity Ready (Zone Selective Interlocking)
- Dynamic Selectivity as per Selectivity Charts
- In Built USB Port for Software Diagnosis
- Switchable Thermal Memory
- Suitable for Isolation

Category	Type	Rated Current (A)	3P			4P		
			Cat.Nos	MRP*/₹/Unit	Pack	Cat.Nos	MRP*/₹/Unit	Pack

Electronic Sg + Energy metering

36 KA	DPX ³ 630	320	4221 77	78370	1	4221 82	89120	1		
		400	4221 78	78370	1	4221 83	89120	1		
		500	4221 79	83168	1	4221 84	100934	1		
		630	4221 80	83168	1	4221 85	100934	1		
	DPX ³ 1600	800	4224 44	155262	1	4224 50	180882	1		
		1000	4224 45	198308	1	4224 51	260542	1		
		1250	4224 46	215068	1	4224 52	290410	1		
		1600	4224 47	227846	1	4224 53	336876	1		
		50 KA	DPX ³ 630	320	4221 87	82312	1	4221 92	95020	1
				400	4221 88	82312	1	4221 93	95020	1
500	4221 89			90590	1	4221 94	110576	1		
630	4221 90			90590	1	4221 95	110576	1		
DPX ³ 1600	800		4224 56	140286	1	4224 62	169268	1		
	1000		4224 57	167542	1	4224 63	252244	1		
	1250		4224 58	238968	1	4224 64	308666	1		
	1600		4224 59	286200	1	4224 65	359282	1		
	70 KA		DPX ³ 630	320	4221 97	93248	1	4222 02	109986	1
				400	4221 98	93248	1	4222 03	109986	1
500		4221 99		104144	1	4222 04	133960	1		
630		4222 00		104144	1	4222 05	133960	1		
DPX ³ 1600		800	4224 68	149008	1	4224 74	193332	1		
		1000	4224 69	235648	1	4224 75	312682	1		
		1250	4224 70	270994	1	4224 76	358830	1		
		1600	4224 71	358946	1	4224 77	419448	1		

Switch disconnecter

	DPX ³ 160	160	4201 98	9820	1	4201 99	12326	1
	DPX ³ 250	250	4202 99	19162	1	4203 00	26352	1
	DPX ³ 630	400	4222 16	27498	1	4222 18	37990	1
		630	4222 17	34364	1	4222 19	44086	1

■ Price available on request.

* MRP - Maximum Retail Price Inclusive of all taxes including GST.

Bold Cat.Nos are products normally available with Legrand (India) Stockists. Cat.Nos that are not bold - delivery within 4 - 8 weeks from the date of order. Bold packing quantity is our mandatory packing. Orders to be placed by Legrand (India) Stockist in multiples of the same.

DPX³ MCCB

Category	Type	Rated Current (A)	3P			4P		
			Cat.Nos	MRP*/₹/Unit	Pack	Cat.Nos	MRP*/₹/Unit	Pack

Only magnetic

16 KA	DPX ³ 160	16	4207 10	14216	1	-	-	-
		25	4207 11	14216	1	-	-	-
		50	4207 12	14216	1	-	-	-
		63	4207 13	14216	1	-	-	-
25 KA	DPX ³ 160	16	4207 14	16164	1	-	-	-
		25	4207 15	16164	1	-	-	-
		50	4207 16	16164	1	-	-	-
		63	4207 17	16164	1	-	-	-
36 KA	DPX ³ 250	100	4207 18	28094	1	-	-	-
		160	4207 19	28094	1	-	-	-
		200	4207 20	29706	1	-	-	-
		250	4207 21	31310	1	-	-	-
70 KA	DPX ³ 250	100	4207 22	27458	1	-	-	-
		160	4207 23	27458	1	-	-	-
		200	4207 24	29178	1	-	-	-
		250	4207 25	30890	1	-	-	-

Accessories

Type	Rotary handle				Shunt release											
	Direct		Vary depth		12 V		24 V		48 V		110 V		230 V		400 V	
	Cat.No	MRP	Cat.No	MRP	Cat.No	MRP	Cat.No	MRP	Cat.No	MRP	Cat.No	MRP	Cat.No	MRP	Cat.No	MRP
DPX ³ 160 DPX ³ 250	4201 60	1400	4201 61	2024	4210 12	2726	4210 13	2726	4210 14	2726	4210 15	2726	4210 16	2726	4210 17	2726
DPX ³ 630	4201 62	2244	4201 63	3844												
DPX ³ 1600	0262 61	4670	0262 83	7160	-		4222 39	2880	4222 40	2880	4222 41	2880	4222 42	2880	4222 43	2880

Type	U/V release													
	12 V		24 V		48 V		110 V		230 V		400 V		480 V	
	Cat.No	MRP	Cat.No	MRP	Cat.No	MRP	Cat.No	MRP	Cat.No	MRP	Cat.No	MRP	Cat.No	MRP
DPX ³ 160 DPX ³ 250	4210 18	3408	4210 19	3408	4210 20	3408	4210 21	3374	4210 22	3374	4210 24	3374	4210 25	3374
DPX ³ 630 DPX ³ 1600	-		4222 45	4078	4222 46	4078	4222 47	4044	4222 48	4044	4222 49	4044	-	

Type	Rated Current (A)	Spreaders**				Motor Operator									
		3P (Set of 3)		4P (Set of 4)		24-230V Side		24V		48V		110V		230V	
		Cat.No	MRP	Cat.No	MRP	Cat.No	MRP	Cat.No	MRP	Cat.No	MRP	Cat.No	MRP	Cat.No	MRP
DPX ³ 160		6250 02	826	6250 06	1100										
DPX ³ 250		6250 14	826	6250 18	1100	4210 60	38462	4210 61	34552	4210 61	34552	4210 61	34552	4210 61	34552
DPX ³ 630	Upto 400 A	4226 31	1650	4226 32	2200										
	630 A	6250 04	1960	6250 08	2520	-		0261 40	71240	0261 41	71240	-		0261 44	55988
DPX ³ 1600	Upto 1250 A	4226 24	11076	4226 25	13452	-		0261 24	135770	0261 25	106470	0261 26	64830	0261 23	64830
	1600 A	0262 73	28854	0262 74	34020	-		0261 19	135770	0261 28	106470	0261 29	64830	0261 27	65448

* MRP - Maximum Retail Price Inclusive of all taxes including GST.
 ■ Price available on request.

Bold Cat.Nos are products normally available with Legrand (India) Stockists.
 Cat.Nos that are not bold - delivery within 4 - 8 weeks from the date of order.
 Bold packing quantity is our mandatory packing. Orders to be placed by Legrand (India) Stockist in multiples of the same.

DPX³ 160

equipment and mounting accessories



4210 40

Cat.Nos	Description	MRP* ₹ / Unit	Pack
---------	-------------	------------------	------

Equipment for plug-in version

4210 40	For DPX ³ 160 - 3P	23076	1
4210 41	For DPX ³ 160 - 4P	30930	1
4210 44	Set of connectors for auxiliary contacts	3306	1
4210 45	Key barrel and flat key for Padlocks	21058	1
4210 46	Key barrel and star key for Padlocks	19072	1
4210 47	Padlock accessory	5852	1

Connection accessories

4210 26	Set of 3 terminals for High capacity cage terminals	8778	1
4210 27	Set of 4 terminals for High capacity cage terminals	11604	1
4210 70	Set of 3 insulated shields	196	1
4210 28	Set of 3 terminals Screw terminals for copper bars connection	998	1
4210 29	Set of 4 terminals Screw terminals for copper bars connection	1080	1
6250 02	Set of 3 spreaders for DPX ³ 160 3P	826	1
6250 06	Set of 4 spreaders for DPX ³ 160 4P	1100	1

Connection accessories

4210 36	Set of 3 rear terminals for DPX ³ 160 3P	4694	1
4210 37	Set of 4 rear terminals for DPX ³ 160 4P	6298	1

Sealable terminal shields

For front terminals

4210 54	For DPX ³ 160 3P	5126	1
4210 55	For DPX ³ 160 3P	5414	1

For rear terminals

4210 50	For DPX ³ 160 3P	3240	1
4210 51	For DPX ³ 160 4P	2882	1

Fixing plates

4210 71	For DPX ³ 160 3P / 4P without earth leakage module	474	1
4210 73	For DPX ³ 160 4P with earth leakage module	1164	1
4210 68	For DPX ³ 160 3P / 4P with side mounting motor operator	1192	1

■ Price available on request.

* MRP - Maximum Retail Price Inclusive of all taxes including GST.

MCCB Prices are without spreaders. For ordering spreaders refer page no. 21

DPX³ 160 and 250

common auxiliaries & accessories



4210 58

Cat.Nos	Description	MRP* ₹ / Unit	Pack
---------	-------------	------------------	------

Supply inverter type

4210 58	For fixed version	4328	1
4210 59	For plug-in and draw-out version	4612	1

Rotary handles

4201 60	Standard handle for thermal magnetic DPX ³	1400	1
4201 61	Vari-depth standard handles	2024	1
4201 67	Key Lock for VD RH DPX ³ 160 & 250	2460	1
4201 65	Key Lock for DIR RH Type A DPX ³ 160 & 250	2390	1
4201 68	Key Lock for VD RH Type A DPX ³ 160 & 250	2460	1
4201 66	Key Lock for DIR RH Type B DPX ³ 160 & 250	2390	1
4201 69	Key Lock for VD RH Type B DPX ³ 160 & 250	2460	1

Motor-driven handles

4210 60	Side motor operator	38462	1
4210 61	Front motor operator	34552	1
4210 62	Ronis key barrel for front motor operator	7894	1
4210 63	Profalux key barrel for front motor operator	18754	1

DPX³ 160 and 250 common auxiliaries & accessories

4210 64	Padlock for front motor operator	2676	1
4210 65	Ronis key barrel for side motor operator	20822	1
4210 66	Profalux key barrel for side motor operator	18920	1
4210 67	Padlock for side motor operator	2840	1

Auxiliary contacts

4210 10	1 N/C + 1 N/O auxiliary contact for rotary handles	1568	1
4210 11	Auxiliary contact or fault signalling contact	1224	1
4210 48	Signalling contact plugged-in/drawn-out (for DPX ³ plug-in version)	1318	1

Locking accessory

4210 49	Padlock for locking in "open" position	1346	1
---------	--	------	---

Communication interface

4210 75	Modbus	17772	1
---------	--------	-------	---

Bold Cat.Nos are products normally available with Legrand (India) Stockists. Cat.Nos that are not bold - delivery within 4 - 8 weeks from the date of order. Bold packing quantity is our mandatory packing. Orders to be placed by Legrand (India) Stockist in multiples of the same.

DPX³ 250

equipment and mounting accessories

Cat.Nos	Description	MRP* ₹ / Unit	Pack
---------	-------------	------------------	------

Equipment for plug-in version

4210 42	For DPX ³ 250 - 3P	25840	1
4210 43	For DPX ³ 250 - 4P with or without earth leakage module	31126	1
4210 44	Set of connectors for auxiliary contacts	3306	1
4210 45	Key barrel and flat key N° ABA90GEL6149 for Padlocks	21058	1
4210 46	Key barrel and star key N° HBA90GPS6149 for Padlocks	19072	1
4210 47	Padlock accessory	5852	1

Connection accessories

4210 30	Set of 3 cage terminals	3540	1
4210 31	Set of 4 cage terminals	4608	1
4210 70	Set of 3 phase barriers	196	1

Connection accessories

6250 14	Set of 3 spreaders for DPX ³ 250 3P	826	1
6250 18	Set of 4 spreaders for DPX ³ 250 4P	1100	1
4210 38	Set of 3 rear terminals for DPX ³ 250 3P	4742	1
4210 39	Set of 4 rear terminals for DPX ³ 250 4P	6386	1

Sealable terminal shields

For front terminals

4210 56	For DPX ³ 250 3P	5308	1
4210 57	For DPX ³ 250 4P	5622	1

For rear terminals

4210 52	For DPX ³ 250 3P	3168	1
4210 53	For DPX ³ 250 4P	3486	1

Fixing plates

4210 72	For DPX ³ 250 3P / 4P without earth leakage module	474	1
4210 74	For DPX ³ 250 4P with earth leakage module	2012	1
4210 69	For DPX ³ 250 3P / 4P with side mounting motor operator	1174	1

DPX³ 630 equipment and accessories

Plug-in version

4222 20	Set of incoming and outgoing terminals - 3P (6 terminals for 3P DPX ³ or 8 terminals for 4P DPX ³)	4190	1
---------	---	------	---

DPX³ 630

equipment and accessories

Cat.Nos	Description	MRP* ₹ / Unit	Pack
---------	-------------	------------------	------

Plug-in version

4222 21	Set of incoming and outgoing terminals - 4P (6 terminals for 3P DPX ³ or 8 terminals for 4P DPX ³)	5238	1
4222 22	Front terminal mounting base for DPX ³ only - 3P	10468	1
4222 24	Flat rear terminal mounting base for DPX ³ only - 3P	16304	1
4222 23	Front terminal mounting base for DPX ³ only - 4P	13100	1
4222 25	Flat rear terminal mounting base for DPX ³ only - 4P	■	1
4222 26	Front terminal mounting base for DPX ³ with earth leakage module - 4 P	■	1
4222 27	Flat rear terminal mounting base for DPX ³ with earth leakage module - 4P	■	1
4222 37	For fixing the signalling contact - 4P Cat.No 0265 74 on a DPX ³ plug-in version	3490	1
4222 28	Set of 2 extractor handle	4890	1
4222 29	Set of connectors (24-pin)	2748	1

Draw-out version

4222 31	"Debro-lift" mechanism for DPX ³ base only - 3P	32136	1
4222 32	"Debro-lift" mechanism for DPX ³ base only - 4P	■	1
4222 33	"Debro-lift" mechanism for DPX ³ base with elm - 4P	■	1
0265 76	One key for "Debro-lift" mechanism for DPX ³ only - Flat key	■	1
0265 78	Two keys (one key supplied) for "Debro-lift" mechanism for motorised DPX ³ or with rotary handle - Flat key	■	1
0263 48	One key for "Debro-lift" mechanism for DPX ³ only - Star key	■	1
0265 77	Two keys (one key supplied) for motorised DPX ³ or with rotary handle - Star key	■	1
0265 75	Handle for drawing-out for "Debro-lift" mechanism	5164	1
0265 74	Signalling contact (plugged-in/drawn-out) for "Debro-lift" mechanism	3272	1
4222 36	For fixing the signalling contact Cat.No 0265 74 on a DPX ³ draw-out version	3516	1

■ Price available on request.

* MRP - Maximum Retail Price Inclusive of all taxes including GST.

MCCB Prices are without spreaders. For ordering spreaders refer page no. 21

Bold Cat.Nos are products normally available with Legrand (India) Stockists. Cat.Nos that are not bold - delivery within 4 - 8 weeks from the date of order. Bold packing quantity is our mandatory packing. Orders to be placed by Legrand (India) Stockist in multiples of the same.

DPX³ 630 equipment and accessories

Cat.Nos	Description	MRP* ₹ / Unit	Pack
---------	-------------	------------------	------

Draw-out version

4222 30	Block of 6 automatic auxiliary contacts for DPX ³ draw-out version (up to 2 blocks by DPX ³)	6798	1
---------	---	------	---

Supply inverter type

0264 09	Plate for MCCB or trip-free switch fixed version	11238	1
0264 04	Plate for MCCB or trip-free switch plug-in and draw-out version	15920	1

Rotary handles

4201 62	Direct rotary handle	2244	1
4201 63	Vari-depth rotary handle	3844	1
4201 70	Key Lock for VD RH DPX ³ 630	2678	1
4201 71	Key Lock for VD RH Type A DPX ³ 630	2678	1
4201 72	Key Lock for VD RH Type B DPX ³ 630	2678	1

Motor-driven handles

0261 40	Front operated 24 V~/=	71240	1
0261 41	Front operated 48 V~/=	71240	1
0261 44	Front operated 230 V~	55988	1
0261 59	Lock and flat key	8862	1
0261 58	Lock and star key	16810	1

Accessories

0262 30	Set of 3 Insulated shields	230	1
0262 44	Set of 2 sealable terminal shields - 3P	6586	1
0262 45	Set of 2 sealable terminal shields - 4P	1950	1
0262 40	Padlock for locking in "OPEN" position - 4P	2358	1
0262 46	Set of 4 adaptors + insulated shields for lug - 4P	9140	1
0262 47	Set of 4 extended front terminals - 4P	6906	1
6250 04	Set of incoming or outgoing spreaders - 3P	1960	1
6250 08	Set of incoming or outgoing spreaders - 4P	2520	1
0263 50	Set of incoming or outgoing swivel rear terminals - 3P	■	1
0263 52	Set of incoming or outgoing flat rear terminals - 3P	22304	1
0263 51	Set of incoming or outgoing swivel terminals - 4P	■	1
0263 53	Set of incoming or outgoing flat terminals - 4P	18934	1
4222 34	Set of 2 IP 20 terminal covers - 3P	1490	1
4222 35	Set of 2 IP 20 terminal covers - 4P	5420	1



0261 40



6250 04



4222 34



4222 35

DPX³ 630 earth leakage module

Type and frame size	Rated Current (A)	Poles	Cat.Nos	MRP* ₹ / Unit	Pack
---------------------	-------------------	-------	---------	------------------	------

Earth Leakage Module

Standard

DPX ³ 630	400 A	3 Pole	0260 60	40660	1
	630 A	3 Pole	0260 64	75722	1
DPX ³ 630	400 A	4 Pole	0260 61	71370	1
	630 A	4 Pole	0260 65	75228	1

LED Version

DPX ³ 630	400 A	4 Pole	0260 63	■	1
	630 A	4 Pole	0260 67	77390	1

DPX³ 1600 equipment and accessories

Cat.Nos	Description	MRP* ₹ / Unit	Pack
---------	-------------	------------------	------

Draw-out version

4225 86	Front terminals - 3P	■	1
4225 88	Rear terminals - 3P	■	1
4225 87	Front terminals - 4P	■	1
4225 89	Rear terminals - 4P	■	1
4225 93	Debtor-lift mechanism For DPX ³ 1600 - 3P	■	1
4225 94	Debtor-lift mechanism for DPX ³ 1600 - 4P	■	1
4225 95	For fixing the signalling contact Cat.No 0265 74 on a DPX ³ draw-out version	■	1
0265 76	One key for "Debtor-lift" mechanism for DPX ³ only - Flat key	■	1
0265 80	Two key (one key supplied) for motorised DPX ³ or with rotary handle	■	1
0263 48	One key for DPX ³ only - Starkey	■	1
0265 79	Two key (one key supplied) for motorised DPX ³ or with rotary handle	■	1
0265 75	Handle for drawing-out for "Debtor-lift" mechanism	5164	1
0265 74	Signalling contact (plugged-in/drawn-out)	3272	1
4222 30	Block of 6 automatic auxiliary contacts for DPX ³ draw-out version (up to 2 blocks by DPX ³)	6798	1



4225 88 + 4225 93

■ Price available on request.

* MRP - Maximum Retail Price Inclusive of all taxes including GST.

Bold Cat.Nos are products normally available with Legrand (India) Stockists. Cat.Nos that are not bold - delivery within 4 - 8 weeks from the date of order. Bold packing quantity is our mandatory packing. Orders to be placed by Legrand (India) Stockist in multiples of the same.

DPX³ 1600 equipment and accessories

Cat.Nos	Description	MRP* ₹ / Unit	Pack
---------	-------------	------------------	------

Supply inverter type

0264 10	Plate for MCCBs or trip-free switch fixed version	13528	1
0264 05	Plate for MCCBs or trip-free switch plug-in and draw-out version	29980	1

Rotary handles

0262 61	Standard (black) direct on DPX ³	4670	1
0262 83	Standard (black) vari-depth handle IP 55	7160	1
0262 93	Key barrel and flat key	2660	1
0262 94	Key barrel and star key	14674	1

Motor-driven handles

0261 54	Front operated 230 V±	85200	1
0261 24	Front operated 24 V±/= for I _n ≤ 1250 A	135770	1
0261 25	Front operated 48 V±/= for I _n ≤ 1250 A	106470	1

Motor-driven handles

0261 26	Front operated 110 V±/= for I _n ≤ 1250 A	64830	1
0261 23	Front operated 230 V±/= for I _n ≤ 1250 A	64830	1
0261 19	Front operated 24 V±/= for I _n = 1600 A	135770	1
0261 28	Front operated 48 V±/= for I _n = 1600 A	106470	1
0261 29	Front operated 110 V±/= for I _n = 1600 A	■	1
0261 27	Front operated 230 V±/= for I _n = 1600 A	65448	1
0261 59	Key and flat key	8862	1
0261 58	Key and star key	16810	1

Accessories

0262 66	Set of 3 insulated shields	454	1
0262 64	Set of 2 sealable terminal shields - 3P	13700	1
0262 65	Set of 2 sealable terminal shields - 4P	2750	1
0262 60	Padlock for locking in "open" position	2360	1
0262 67	Set of 4 extended front short terminals for 630 - 1250 A (2 bars max. per pole)	16640	1



0262 60

- Price available on request.
- * MRP - Maximum Retail Price Inclusive of all taxes including GST.
- ❖ For Cat.Nos. and further details please contact th nearest branch.
- ▼ For communication add 4226 82 + 4226 89

DPX³ 630 and 1600 common auxiliaries

Cat.Nos	Description	MRP* ₹ / Unit	Pack
---------	-------------	------------------	------

Accessories

0262 68	Set of 4 extended front Long terminals for 1600 A (3 bars max. per pole)	23430	1
4226 24	Set of incoming or outgoing spreaders for 800 A & 1000 A - 3P	11076	1
4226 25	Set of incoming or outgoing spreaders for 800 A & 1000 A - 4P	13452	1
0262 73	Set of incoming or outgoing spreaders for 1250 A & 1600 A - 3P	28854	1
0262 74	Set of incoming or outgoing spreaders for 1250 A & 1600 A - 4P	34020	1
0263 80	Short rear terminals - 3P	■	1
0263 81	Long rear terminals - 3P	■	1
0263 82	Short rear terminals - 4P	■	1
0263 83	Long rear terminals - 4P	■	1
4225 90	Set of 2 IP 20 terminal covers - 3P	1730	1
4225 91	Set of 2 IP 20 terminal covers - 4P	2820	1
4225 92	External neutral - 4P	17536	1



0262 67 + 0262 68

Common auxiliaries

4210 11	For signalling the state of the contacts or opening of the MCCB on a fault For DPX ³ /DPX ³ -I Changeover switch 3 A - 240 V±	1224	1
---------	--	------	---

Releases

Allow remote tripping of a DPX³

Time-lag undervoltage releases (800 ms)

Prevent false tripping in the event of power supply microbreaks.

Require a time-lag module connected to the undervoltage release Cat.No 4226 23

0261 90	Time-lag module 230 VA 3 module	24680	1
---------	------------------------------------	-------	---

Bold Cat.Nos are products normally available with Legrand (India) Stockists. Cat.Nos that are not bold - delivery within 4 - 8 weeks from the date of order. Bold packing quantity is our mandatory packing. Orders to be placed by Legrand (India) Stockist in multiples of the same.

DPX³ MCCB

Rotary handles
for DPX³



- Smaller dimension of rotary handle base for better visibility of parameters and better access to trip unit
- Easy installation
- Spring for better play
- Door defeat mechanism for easy maintenance
- ON / OFF indication on the knob
- Pad Locking on the knob – upto 3 Locks



Scan to know more about
the product.

Cat.Nos	Description	MRP* ₹ / Unit	Pack
---------	-------------	------------------	------

Releases

0261 91	Time-lag module 400 VA	36020	1
4226 23	Undervoltage release for DPX ³ 630 and 1600	■	1

Auto Transfer Controller

4226 81	Standard unit	36860	1
4226 82	Advanced unit	43000	1
4226 89▼	Communication module	11528	1

Residual current relay

0260 88	Residual current relay to clip on module 2 rail	25600	1
---------	--	-------	---

Current Transformer

0260 92	Coil Ø35 mm	14680	1
0260 93	Coil Ø80 mm	20396	1
0260 94	Coil Ø110 mm	33020	1
0260 95	Coil Ø140 mm	34750	1
0260 96	Coil Ø210 mm	59270	1
0260 97	Coil Ø150 mm - open	■	1
0260 98	Coil Ø300 mm - open	■	1

Metal one way enclosures for MCCB

Cat.Nos	Description	No. of modules	MRP* ₹ / Unit	Pack
5078 01	DPX3 160 MCCB enclosure	3&4	5192	1
5078 02	DPX3 250 MCCB enclosure	3&4	9130	1
5078 04	DPX3 630 MCCB enclosure	3&4	13974	1



4226 82



0260 88



0260 93
coil for use
with relay



0260 98

■ Price available on request.

* MRP - Maximum Retail Price Inclusive of all taxes including GST.

❖ For Cat.Nos. and further details please contact th nearest branch.

▼ For communication add 4226 82 + 4226 89

Bold Cat.Nos are products normally available with Legrand (India) Stockists.
Cat.Nos that are not bold - delivery within 4 - 8 weeks from the date of order.
Bold packing quantity is our mandatory packing. Orders to be placed by
Legrand (India) Stockist in multiples of the same.

DRX

MCCB RANGE

MCCB RANGE



DRX MCCB WORLD CLASS SOLUTION WITH A RANGE OF ACCESSORIES AND WINNING FEATURES

NEW DRX MCCBs RANGE. MULTIPLE FEATURES.



Accurate performance at higher temperature "No Deration upto 50° Cel"



Overload & Overload Pre-Alarm Indication



Integrated Contact module for Status Indication



Complete Range with Adjustable Protection



In built Neutral Protection in 4th Pole



Switchable Thermal Memory



Over - Temperature Alarm Indication



Adjustable Time Settings



A COMPREHENSIVE RANGE

The robust design of DRX MCCB offer adjustable protection, different accessories for connection and remote tripping. They are the ideal choice in terms of efficiency and affordability for protection of your electrical installations of up to 630A.



Scan to know more about the product.

DRX MCCB

DRX MCCB with Thermal Magnetic Protection Unit

Range – 16A to 630A

Ics = 100% Icu

Thermal Adjustable – 0.8 to 1 In

Magnetic Setting – 10 In for DRX125HP

Magnetic Setting – Adjustable 5 to 10 In for DRX250HP and DRX630

Suitable for Isolation

Category	Type	Rated Current (A)	3P			4P		
			Cat.Nos	MRP*/₹/Unit	Pack	Cat.Nos	MRP*/₹/Unit	Pack

Thermal Magnetic : O/L & S/C protection

25 KA	DRX 125 ^{HP}	16	6697 00	8098	1	6697 10	11256	1
		20	6697 01	8098	1	6697 11	11256	1
		25	6697 02	8098	1	6697 12	11256	1
		32	6697 03	8098	1	6697 13	11256	1
		40	6697 04	8098	1	6697 14	11256	1
		50	6697 05	8098	1	6697 15	11256	1
		63	6697 06	8098	1	6697 16	11256	1
		80	6697 07	8098	1	6697 17	11256	1
		100	6697 08	8098	1	6697 18	11256	1
		125	6697 09	11992	1	6697 19	14220	1
36 KA	DRX 125 ^{HP}	16	6697 20	10542	1	6697 30	13154	1
		20	6697 21	10542	1	6697 31	13154	1
		25	6697 22	10542	1	6697 32	13154	1
		32	6697 23	10542	1	6697 33	13154	1
		40	6697 24	10542	1	6697 34	13154	1
		50	6697 25	10542	1	6697 35	13154	1
		63	6697 26	10542	1	6697 36	13154	1
		80	6697 27	10542	1	6697 37	13154	1
		100	6697 28	10542	1	6697 38	13154	1
		125	6697 29	12126	1	6697 39	15302	1
50 KA	DRX 125 ^{HP}	16	6697 40	13472	1	6697 50	16974	1
		20	6697 41	13472	1	6697 51	16974	1
		25	6697 42	13472	1	6697 52	16974	1
		32	6697 43	13472	1	6697 53	16974	1
		40	6697 44	13472	1	6697 54	16974	1
		50	6697 45	13472	1	6697 55	16974	1
		63	6697 46	13472	1	6697 56	16974	1
		80	6697 47	13472	1	6697 57	16974	1
		100	6697 48	13472	1	6697 58	16974	1
		125	6697 49	17654	1	6697 59	20342	1

■ Price available on request.

* MRP - Maximum Retail Price Inclusive of all taxes including GST.

Bold Cat.Nos are products normally available with Legrand (India) Stockists. Cat.Nos that are not bold - delivery within 4 - 8 weeks from the date of order. Bold packing quantity is our mandatory packing. Orders to be placed by Legrand (India) Stockist in multiples of the same.

DRX MCCB

DRX MCCB with Thermal Magnetic Protection Unit

Category	Type	Rated Current (A)	3P			4P		
			Cat.Nos	MRP*/₹/Unit	Pack	Cat.Nos	MRP*/₹/Unit	Pack
Thermal Magnetic : O/L & S/C protection								
25 KA	DRX 250 ^{HP}	16	6690 00	■	1	6690 20	■	1
		20	6690 01	■	1	6690 21	■	1
		25	6690 02	■	1	6690 22	■	1
		32	6690 03	■	1	6690 23	■	1
		40	6690 04	■	1	6690 24	■	1
		50	6690 05	■	1	6690 25	■	1
		63	6690 06	■	1	6690 26	■	1
		80	6690 07	■	1	6690 27	■	1
		100	6690 08	■	1	6690 28	■	1
		125	6690 09	■	1	6690 29	■	1
		160	6690 10	17158	1	6690 30	19908	1
		200	6690 11	19540	1	6690 31	23940	1
		250	6690 12	22712	1	6690 32	27174	1
		36 KA	DRX 250 ^{HP}	16	6690 40	■	1	6690 60
20	6690 41			■	1	6690 61	■	1
25	6690 42			■	1	6690 62	■	1
32	6690 43			■	1	6690 63	■	1
40	6690 44			■	1	6690 64	■	1
50	6690 45			■	1	6690 65	■	1
63	6690 46			■	1	6690 66	■	1
80	6690 47			■	1	6690 67	■	1
100	6690 48			■	1	6690 68	■	1
125	6690 49			■	1	6690 69	■	1
160	6690 50			17336	1	6690 70	20160	1
200	6690 51			21462	1	6690 71	27720	1
250	6690 52			24570	1	6690 72	29600	1
DRX 630	DRX 630			320	6676 50	30138	1	6676 54
		400	6676 51	30138	1	6676 55	37386	1
		500	6676 52	38854	1	6676 56	48886	1
		630	6676 53	38854	1	6676 57	51214	1



6676 51

■ Price available on request.

* MRP - Maximum Retail Price Inclusive of all taxes including GST.

Bold Cat.Nos are products normally available with Legrand (India) Stockists. Cat.Nos that are not bold - delivery within 4 - 8 weeks from the date of order. Bold packing quantity is our mandatory packing. Orders to be placed by Legrand (India) Stockist in multiples of the same.

DRX MCCB

DRX MCCB with Thermal Magnetic Protection Unit

Category	Type	Rated Current (A)	3P			4P		
			Cat.Nos	MRP*/₹/Unit	Pack	Cat.Nos	MRP*/₹/Unit	Pack
Thermal Magnetic : O/L & S/C protection								
50 KA	DRX 250 ^{HP}	16	6690 80	■	1	6691 00	■	1
		20	6690 81	■	1	6691 01	■	1
		25	6690 82	■	1	6691 02	■	1
		32	6690 83	■	1	6691 03	■	1
		40	6690 84	■	1	6691 04	■	1
		50	6690 85	■	1	6691 05	■	1
		63	6690 86	■	1	6691 06	■	1
		80	6690 87	■	1	6691 07	■	1
		100	6690 88	■	1	6691 08	■	1
		125	6690 89	■	1	6691 09	■	1
		160	6690 90	21630	1	6691 10	25200	1
		200	6690 91	26166	1	6691 11	32560	1
	250	6690 92	28140	1	6691 12	34650	1	
	DRX 630	320	6676 58	33178	1	6676 62	41730	1
		400	6676 59	33178	1	6676 63	41730	1
500		6676 60	47000	1	6676 64	58716	1	
630		6676 61	47000	1	6676 65	58716	1	



6690 92



6676 61

DRX MCCB

DRX MCCB with Electronic S2 (LSI) Protection Unit

- Range: 40A – 630A, Ics=100%Icu, Two Optimum Frames
- Protection against overloads:
 - Ir adjustable from 0.4 to 1 x In
 - tr adjustable from 3 to 30s#
- Protection against short circuits:
 - I_{sd} adjustable from 1.5 to 10 x Ir
 - t_{sd} adjustable from 0 to 0.5s
- Inbuilt Instantaneous Protection:
 - li# – Fixed
- Overload Alarm Indication - I > 1.05 Ir
- Pre-Overload Alarm Indication - I > 0.9 Ir
- Over temperature Alarm Indication - T > 90 °C
- Integrated Contact Module (On/Off/ Trip) for DRX 250HP Electronic MCCBs
- Suitable for Isolation

Category	Type	Rated Current (A)	3P			4P		
			Cat.Nos	MRP*/₹/Unit	Pack	Cat.Nos	MRP*/₹/Unit	Pack

Electronic S2

36 KA	DRX 250 ^{HP}	40	6691 70	18578	1	6691 80	23616	1
		100	6691 71	18578	1	6691 81	23616	1
		160	6691 72	23776	1	6691 82	33254	1
		250	6691 73	32628	1	6691 83	44534	1
	DRX 630	320	6699 01	41918	1	6699 06	51636	1
		400	6699 02	41918	1	6699 07	51636	1
		630	6699 04	47082	1	6699 09	61662	1

* MRP - Maximum Retail Price Inclusive of all taxes including GST.
 ■ Price available on request.

Bold Cat.Nos are products normally available with Legrand (India) Stockists. Cat.Nos that are not bold - delivery within 4 - 8 weeks from the date of order. Bold packing quantity is our mandatory packing. Orders to be placed by Legrand (India) Stockist in multiples of the same.

DRX MCCB

DRX MCCB with Electronic S2 (LSI) Protection Unit

Electronic S2

50 KA	DRX 250 ^{HP}	40	6691 90	22388	1	6692 00	30914	1
		100	6691 91	22388	1	6692 01	30914	1
		160	6691 92	29084	1	6692 02	38130	1
		250	6691 93	37124	1	6692 03	47560	1
	DRX 630	320	6699 11	45868	1	6699 16	58470	1
		400	6699 12	45868	1	6699 17	58470	1
		630	6699 14	50878	1	6699 19	65152	1

DRX MCCB

DRX MCCB with Electronic Sg (LSIg) Protection Unit

- Range: 40A – 630A, Ics=100%Icu, Two Optimum Frames
- Protection against overloads:
 - Ir adjustable from 0.4 to 1 x In
 - tr adjustable from 3 to 30s#
- Protection against short circuits:
 - I_{sd} adjustable from 1.5 to 10 x Ir
 - t_{sd} adjustable from 0 to 0.5s
- Inbuilt Instantaneous Protection:
 - I_# – Fixed
- Protection against Ground Fault:
 - I_g adjustable from 0.2 to 1 In & OFF
 - t_g adjustable from 0.1 to 1s
- Overload Alarm Indication - I > 1.05 Ir
- Pre-Overload Alarm Indication - I > 0.9 Ir
- Over temperature Alarm Indication - T > 90 °C
- Integrated Contact Module (On/Off/ Trip) for DRX 250HP Electronic MCCBs
- Suitable for Isolation

Category	Type	Rated Current (A)	3P			4P		
			Cat.Nos	MRP*/₹/Unit	Pack	Cat.Nos	MRP*/₹/Unit	Pack

Electronic Sg

36 KA	DRX 250 ^{HP}	40	6691 75	33600	1	6691 85	39066	1
		100	6691 76	33600	1	6691 86	39066	1
		160	6691 77	38284	1	6691 87	46882	1
		250	6691 78	45320	1	6691 88	56256	1
	DRX 630	320	6699 21	56930	1	6699 26	65498	1
		400	6699 22	56930	1	6699 27	65498	1
		630	6699 24	61602	1	6699 29	76190	1
50 KA	DRX 250 ^{HP}	40	6691 95	36724	1	6692 05	43544	1
		100	6691 96	36724	1	6692 06	43544	1
		160	6691 97	43754	1	6692 07	51950	1
		250	6691 98	49226	1	6692 08	58064	1
	DRX 630	320	6699 31	58910	1	6699 36	71090	1
		400	6699 32	58910	1	6699 37	71090	1
		630	6699 34	63582	1	6699 39	79302	1



6691 98

- Price available on request.
- * MRP - Maximum Retail Price Inclusive of all taxes including GST.

Bold Cat.Nos are products normally available with Legrand (India) Stockists. Cat.Nos that are not bold - delivery within 4 - 8 weeks from the date of order. Bold packing quantity is our mandatory packing. Orders to be placed by Legrand (India) Stockist in multiples of the same.

DRX MCCB

DRX MCCB Accessories

Shunt Release	Voltage	CAT No.	MRP* ₹ / Unit	Pack
---------------	---------	---------	------------------	------

Internal Accessories

DRX 125HP	240V AC	0271 54	2268	1
DRX 250HP				
DRX 630	240V AC	4222 42	2880	1
DRX 125HP	415V AC	0271 55	2268	1
DRX 250HP				
DRX 630	415V AC	4222 43	2880	1

Undervoltage Release	Voltage	CAT No.	MRP* ₹ / Unit	Pack
----------------------	---------	---------	------------------	------

DRX 125HP	240V AC	0271 64	3150	1
DRX 250HP				
DRX 630	240V AC	4222 48	4044	1
DRX 125HP	415V AC	0271 65	3150	1
DRX 250HP				
DRX 630	415V AC	4222 49	4044	1

Auxilliary Contact	Type	CAT No.	MRP* ₹ / Unit	Pack
--------------------	------	---------	------------------	------

DRX 125HP	1 C/O	0271 40	1050	1
DRX 250HP				
DRX 630	1 C/O	4210 11	1224	1

DRX MCCB

DRX MCCB Accessories

Trip Alarm Contact	Type	CAT No.	MRP* ₹ / Unit	Pack
--------------------	------	---------	------------------	------

DRX 125HP	1 C/O	0271 41	1050	1
DRX 250HP				
DRX 630	1 C/O	4210 11	1224	1

Auxilliary + Trip Alarm Combo	Type	CAT No.	MRP* ₹ / Unit	Pack
-------------------------------	------	---------	------------------	------

DRX 125HP	1 Aux + 1 Trip	0271 42	1838	1
DRX 250HP				

External Accessories

Rotary Handles	Type	CAT No.	MRP* ₹ / Unit	Pack
----------------	------	---------	------------------	------

DRX 125HP	Direct	6687 70	1206	1
DRX 250HP	Direct	6687 72	1228	1
DRX 630	Direct	6687 80	2152	1
DRX 125HP	Vary Depth	6687 71	1850	1
DRX 250HP	Vary Depth	6687 73	1906	1
DRX 630	Vary Depth	6687 81	3554	1

* MRP - Maximum Retail Price Inclusive of all taxes including GST.
 ■ Price available on request.

Bold Cat.Nos are products normally available with Legrand (India) Stockists. Cat.Nos that are not bold - delivery within 4 - 8 weeks from the date of order. Bold packing quantity is our mandatory packing. Orders to be placed by Legrand (India) Stockist in multiples of the same.

Spreader	Type	CAT No.	MRP* ₹ / Unit	Pack
DRX 125HP	3P One Side	6250 10	264	1
DRX 250HP	3P One Side	6250 14	826	1
DRX 630	400A 3P One Side	4226 31	1650	1
	630A 3P One Side	6250 04	1960	1
DRX 125HP	4P One Side	6250 11	374	1
DRX 250HP	4P One Side	6250 18	1100	1
DRX 630	400A 4P One Side	4226 32	2200	1
	630A 4P One Side	6250 08	2520	1

Phase Barriers	Type	CAT No.	MRP* ₹ / Unit	Pack
DRX 125HP				1
	3P One Side	6693 00	160	
DRX 250HP				1



0271 80

Phase Barriers	Type	CAT No.	MRP* ₹ / Unit	Pack
DRX 630	3P One Side	0262 30	230	1
DRX 125HP				1
DRX 250HP	4P One Side	6693 01	208	1
DRX 630	4P One Side	0262 30	230	1

Key Locks	Type	CAT No.	MRP* ₹ / Unit	Pack
For DRX 125HP/250HP suitable for				
Random	A	6687 74	2436	1
Direct Handle	B	6687 75	2436	1
Direct Handle	B	6687 76	2436	1
For DRX 125HP/250HP suitable for Vary Depth Handle				
Random	A	6687 77	2394	1
	A	6687 78	2394	1
	B	6687 79	2394	1
For DRX 630 suitable for Vary Depth Handle				
Random	A	6687 82	2394	1
	A	6687 83	2394	1
	B	6687 84	2394	1

Padlocks	Type	CAT No.	MRP* ₹ / Unit	Pack
DRX 125HP	-	0271 80	166	1
DRX 250HP	-	0271 80	166	1
DRX 630	-	0262 40	2358	1

* MRP - Maximum Retail Price Inclusive of all taxes including GST.
 ■ Price available on request.

Bold Cat.Nos are products normally available with Legrand (India) Stockists. Cat.Nos that are not bold - delivery within 4 - 8 weeks from the date of order. Bold packing quantity is our mandatory packing. Orders to be placed by Legrand (India) Stockist in multiples of the same.

LBPLUS DATA

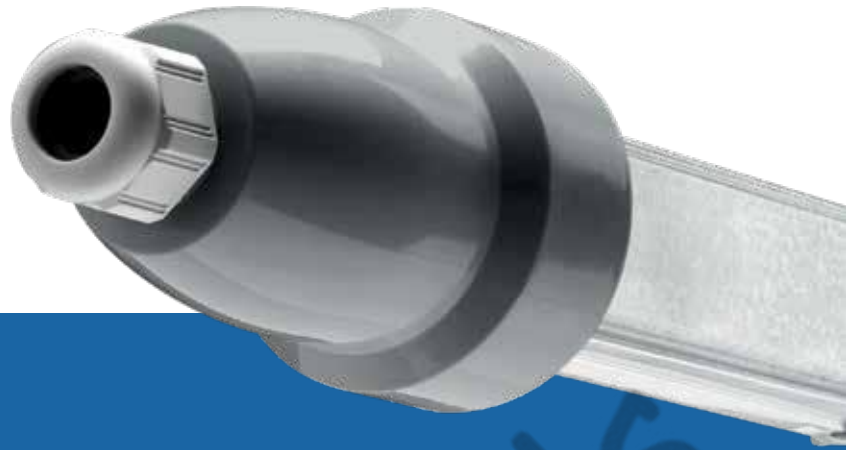

LIGHTING BUSBAR FOR EFFICIENT LIGHTING MANAGEMENT

SIMPLIFIED INSTALLATION FOR INCREASED PERFORMANCE



ENERGY EFFICIENCY

Integrate with dimming systems and lux meters for daytime electricity savings



SIMPLICITY WITH COMFORT

Completely addressable system for user convenience and remote management



MAXIMUM FLEXIBILITY OF USE

The certified protocols that can be used with LBplus data are the DALI and the 1-10 V protocols.



ENVIRONMENT SUSTAINABILITY

With the reduction of energy consumption, there is also an important reduction in the emission of polluting gases in the atmosphere. Renewable energy sources are not the only mean for reaching the environmental sustainability objectives: the starting point is certainly the reduction of existing consumptions



ENERGY SAVING

With LBplus data there is a reduction of both energy consumption due to artificial illumination (upto 75%, according to UNIEN 15193), and energy waste, thanks to the automatic management of lighting



COMPLIANCE WITH THE STANDARDS

With LBplus data, compliance with the EU Directives on energy efficiency both for new and for refurbished buildings is ensured



APPLICATIONS / CAN BE USED AT



SHOPPING CENTRES,
STORES, OFFICES...



WAREHOUSES, GYMS,
UNDERGROUND car parks...



HOSPITALS,
LABORATORIES...



WORKSHOPS, MAINTENANCE & REPAIR
FACILITIES, PRODUCTION SITES...



Scan to know more about
the product.

IP68 RCP

RESIN BUSBAR TRUNKINGS



A SOLUTION THAT ADAPTS TO INDOOR AND OUTDOOR INSTALLATIONS

The **RCP IP68** resin busbar trunking system is a solution mainly for outdoor in extreme conditions such as humidity, corrosion or saline mist environment and temporary immersion risks.

RCP IP68 Resin Busbar

New resin busbar RCP with range from 630 A to 6300 A and IP68 degree of protection represents the complete solution for the **transport** of high-power energy.

This new product is made with internal conductors in aluminium or copper and completely embedded in **a epoxy resin**, which provides mechanical strength and electrical insulation. With RCP is possible to provide specific solutions in different environments (outdoor and indoor) where it isn't possible to reach with busbar IP55.



Scan to know more about the product.

DEGREE OF PROTECTION

IP68

1ST DIGIT IP

Protection against penetration of solid bodies

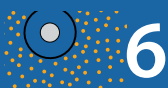

Complete protection against dust

2ND DIGIT IP

Protection against penetration of liquids

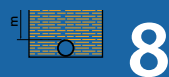

Protection against effects of Immersion under pressure

(At maximum of 1m, as comply by standard EN 61439-6)

BUSBAR TRUNKING

- Resin built-in conductors.
- Insulations of single conductors in polyester film.
- Fully insulated with epoxy resin.
- Rated current between 630 - 6300 A.
- Insulation voltage up to 1000 V.
- Small dimensions.
- Maintenance free.
- Only for Transport of energy.

CONDUCTOR MATERIAL

- Copper: copper busbars with a purity greater than 99.9% .
- Aluminium: aluminium alloy busbars, with entire surface treated with different galvanic processes.
- Degree of protection: IP68 according to the EN 61439-6.

Typical applications

The typical applications of IP68 busbar trunkings are



Industrial plants



Petrochemical plants



Chemical plants (*).



Outdoor (in different extreme conditions).

(* attention at chemical components which are not compatible with the busbar's resin

DSX

SAFETY, STRENGTH
AND EASE OF
INSTALLATION



New range for power
switching needs of
modern installation

ON A DIN RAIL

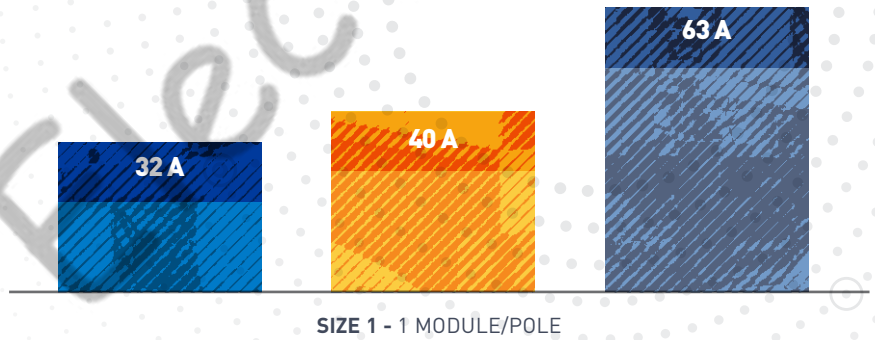

SIZE 1 - 1 MODULE/POLE

ON A PLATE

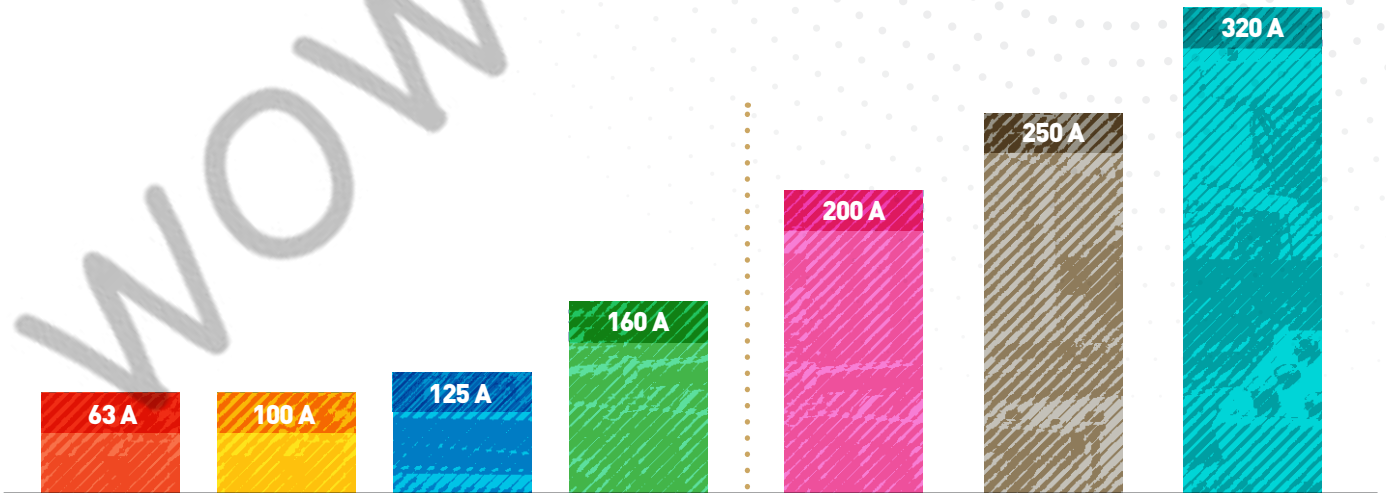

SIZE 1

SIZE 2



Scan to know more about
the product.



Features:

- Operational Voltage upto 690V AC
- High Electrical and Mechanical Life
- Patented Features - Pop Ind & Visual Contacts
- Best in class accessories

Modular



SD DIN LINE



TSE DIN LINE

Plate Mounted



SD POWER LINE



TSE POWER LINE



DSX

NEW RANGE FOR POWER SWITCHING NEEDS OF MODERN INSTALLATIONS

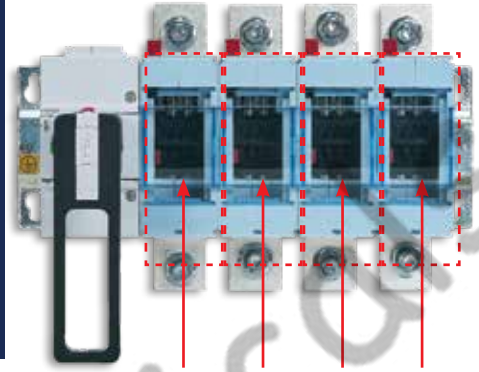

The physical separation of the main contacts is visible through a transparent cover.



Pop up indicators

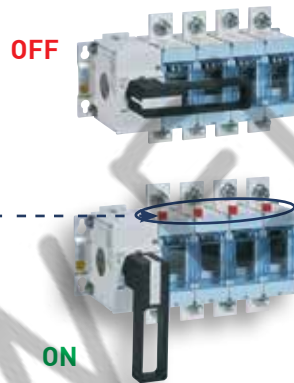

OFF

ON



Innovative Design



Safe



Ease of Installation



Robust

BEST IN CLASS ACCESSORIES FOR SAFETY AND PERFORMANCE

Accessories:



Terminal Shields

Source Separator

Aux Contacts for Indication & Early Make/Break

Vary Depth Handle

Shorting Link

Spreaders

NEW! DSX SD/TSE

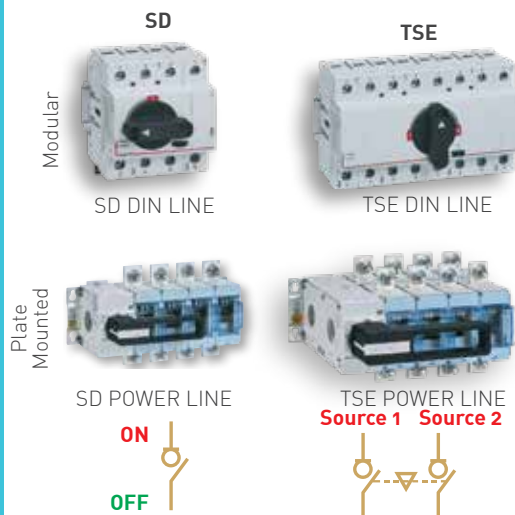

Frame -->	DIN LINE 1	POWER LINE 1	POWER LINE 2
Ratings	32A, 40A, 63A	63A, 100A, 125A, 160A	200A, 250A, 320A
Rated Operational Voltage, Ue	690V AC	690V AC	
Rated Insulation Voltage, Ui	690V AC	1000V AC	
Rated Impulse Voltage, Uimp	8kV	8kV	12kV
Mechanical Life	10000	10000	10000
Electrical Life	2000	2500	2000
Icw for 1 Sec	1.5kA	8kA	12.5kA

@12000 for DIN LINE 1 SD/ 10000 for DIN LINE 1 TSE

Type	Rated Current (A)	Switch Disconnecter			TSE (Changeover Switch)			TSE (Changeover Switch) with Enclosure		
		Cat.Nos	MRP*/₹/Unit	Pack	Cat.Nos	MRP*/₹/Unit	Pack	Cat.Nos	MRP*/₹/Unit	Pack
DIN Line Frame 1 (3P + N)	32A	4240 06	3120	1	4241 06	5580	1			
	40A	4240 07	3270	1	4241 07	5830	1			
	63A	4240 08	3890	1	4241 08	6800	1			
POWER Line Frame 1 (4P)	63A	4240 82	4650	1	4241 82	8184	1	4241 92	12200	1
	100A	4240 83	8590	1	4241 83	10280	1	4241 93	14830	1
	125A	4240 84	10540	1	4241 84	14020	1	4241 94	17030	1
	160A	4240 85	14220	1	4241 85	15960	1	4241 95	21940	1
POWER Line Frame 2 (4P)	200A	4240 86	15450	1	4241 86	21342	1	4241 96	26182	1
	250A	4240 87	18060	1	4241 87	29460	1	4241 97	35290	1
	320A	4240 88	19950	1	4241 88	30180	1	4241 98	36980	1

Accessories

	DIN LINE 1		
	Cat.Nos	MRP*/₹/Unit	Pack
Shorting Links for TSE (set of 4)	4242 01	870	1
Terminal Shield IP20 - 3P*	4242 02	360	1
Terminal Shield IP20 - 1P*	4242 03	280	1
Auxiliary contact (1 NO + 1 NC)	4242 08	460	1
Vary Depth Handle	4242 09	1278	1

	POWER LINE 1			POWER LINE 2		
	Cat.Nos	MRP*/₹/Unit	Pack	Cat.Nos	MRP*/₹/Unit	Pack
Auxiliary contact 4 NO + 4NC	4242 45	1278	1	4242 45	1278	1
Aux Contact (1NO+1NC) Early Make/Break	4242 44	1500	1	4242 44	1500	1
Spreaders Terminals (One Side i.e. Set of 4)	4242 54	1000	1	4242 38	2000	1
Terminal Shield IP20 - 4P	4242 47	1022	1	4242 36	1176	1
Phase Barriers	4242 51	204	1	4242 43	256	1
Inter Source Barrier	4242 52	256	1	4242 39	410	1
Shorting Links for TSE (Set of 4)	4242 49	2456	1	4242 41	3682	1
Direct Handle	4242 30	1074	1	4242 30	1074	1
Vary Depth Handle	4242 31	1534	1	4242 31	1534	1
Direct Key Lock	4242 34	1074	1	4242 34	1074	1

To be Ordered together as 1 set for 4P SD and 2 sets for 4P TSE.

SD POWER LINE --> Packaging Includes SD, Phase Barriers, Vary Depth Handle.

TSE POWER LINE --> Packaging Includes TSE, Phase Barriers, Inter Source Barrier, Vary Depth Handle, Shorting Links.

E-communicating Infrastructure

Cat.Nos	Description	MRP* ₹ / Unit	Pack
---------	-------------	------------------	------

Power Supervision System

Remote control, Monitoring and Measurement

Communication Accessories for ACB

0288 05	Communication option - for DMX ³ electronic protection units (Factory Fitted)	■	1
0288 06	Power supply - external - 12 V DC - for DMX ³ electronic protection units	■	1



0288 06

Communication Modules

Modules programmable output

Features

Programmable electronic device capable of controlling 6 relay outputs. The device can work in three different ways, with DMX³, with DPX³ or as Independent module depending on the product it is associated with

6 Programmable relay outputs with 230 V, 8 A contacts

Communication is ensured by the Modbus protocol.

0288 12	Modules programmable output	■	1
---------	-----------------------------	---	---



0288 12

Signalling and control interface

Features

Signalling and control interface between the power supervision system and the **thermal magnetic or electronic circuit breakers**.

Equipped with analogue / digital inputs and relay outputs.

Can handle multiple circuit breakers.

24 inputs for collecting information from the signalling auxiliaries on the DPX³ and DMX³ circuit breakers: auxiliary contact NO position (1 input) or

E-communicating Infrastructure

Cat.Nos	Description	MRP* ₹ / Unit	Pack
---------	-------------	------------------	------

NO+NC position (2 inputs), fault signal (1 input)

6 outputs for: the remote control of the motor

driven circuit breakers (2 outputs) and for tripping the circuit breakers (1 output)

Communication is ensured by the Modbus protocol.

Address, speed and coding can be modified with configuration kit.

0261 36	Signalling and control interface	■	1
---------	----------------------------------	---	---



0261 36

Communication accessories for MCCB

Features

RS485 communication interface

Potential free contact for circuit breaker tripped

status information max. 220 V 0.2 A

4210 75	DPX ³ electronic interface For connecting electronic DPX ³ to an RS485 Modbus communication network Note: 24 V _{DC} is required to power up the module	■	1
4210 83	Auxiliary power supply for DPX ³ - 24 V _{AC} - 250 mA Can be used to power upto 8 breakers	■	1



4210 75



4210 83

Communication accessories for MCB

Features

RS485 communication interface

Potential free contact for circuit breaker tripped

status information max. 220 V 0.2 A

Can be connected with DX3 add on Modules (4106 57/58/59)

4210 75	DPX ³ electronic interface For connecting electronic DPX ³ to an RS485 Modbus communication network Note: 24 V _{DC} is required to power up the module	■	1
---------	---	---	---

* MRP - Maximum Retail Price Inclusive of all taxes including GST.
(1) Price in Meters; No of meters in Pack, Standard length 2 meters to be ordered in multiple of 2 meters.

Bold Cat.Nos are products normally available with Legrand (India) Stockists. Cat.Nos that are not bold - delivery within 4 - 8 weeks from the date of order. Bold packing quantity is our mandatory packing. Orders to be placed by Legrand (India) Stockist in multiples of the same.

E-communicating Infrastructure

Cat.Nos	Description	MRP* ₹ / Unit	Pack
---------	-------------	------------------	------

Panel Board Display

Optional touch screen allowing to:

Visualize information coming from DX³, DPX³ and DMX³ protection devices and EMDX³ multi-function measuring units and Can manage up to 9 devices

Power supply: 18-30 V=

IP connection

For mounting on door or solid faceplate

Door cut: 92 x 92 mm



0261 56

0261 56	Door mounting touch screen	22780	1
---------	----------------------------	-------	---

Communication accessories



0261 45

0261 45	Configurator kit For configuring the DPX and DPX ³ I/O card and interface Kit with configurators 0 to 9 (10 configurators for each digit)	■	1
0046 89	IP converter For RS 485/ Ethernet conversion for connecting electricity meters and measurement control units to an IP network	■	1
1466 23	Stabilised switched modules power supply- single phase -75-960 W-output 24 V=-120 W	■	1



0046 89



1466 23

Energy management software for 1 computer

(user licence key)

Allows remote configuration, test, control and visualization of data 30-day free trial version

E-communicating Infrastructure

Cat.Nos	Description	MRP* ₹ / Unit	Pack
---------	-------------	------------------	------

available for download via E-Catalogue

4149 38	Software licence agreement (user key) for 32 Modbus addresses or 32 pulse modules	■	1
4149 39	Software licence agreement (user key) 255 Modbus addresses or 255 pulse modules	■	1

Energy management multi-support web servers

Allow remote configuration, test, control and visualization, via a web browser on PCs, smartphones, web viewers, tablet computers, of data Converter

Features

In-built IP convertor

Power supply: 9 to 28 V= with the help of a single-phase switching mode power supply Cat.No 1467

21 to be ordered separately. With the Legrand

Power supervision system, circuit breakers are integrated in a supervision system

You can therefore check the status of the circuit breakers, measure the electrical values and control the circuit breakers remotely.

MODBUS protocol



4149 48

4149 47	For 10 Modbus addresses or 10 pulse modules	■	1
4149 48	For 32 Modbus addresses or 32 pulse modules	■	1
4149 49	For 255 Modbus addresses or 255 pulse modules Supplied with external power supply and fixing brackets	■	1

* MRP - Maximum Retail Price Inclusive of all taxes including GST.
(1) Price in Meters; No of meters in Pack, Standard length 2 meters to be ordered in multiple of 2 meters.

Bold Cat.Nos are products normally available with Legrand (India) Stockists. Cat.Nos that are not bold - delivery within 4 - 8 weeks from the date of order. Bold packing quantity is our mandatory packing. Orders to be placed by Legrand (India) Stockist in multiples of the same.

COMMUNICATION ARCHITECTURE

PROTECTION

MEASUREMENT

CONTROL AND SIGNALLING

RESIDENTIAL

DX³ Ph+N MCBs



408614



408590

EMDX³ energy meters



4120 45



4120 81



4120 91



406295



406252



026136

Auxiliaries
and motorised
control

+

I/O interface

COLLECTIVE HOUSING AND
SMALL OFFICE BUILDINGS

DX3 MCBs



408614



408590

EMDX³ measuring
units



4120 53

EMDX³
energy
meters



4120 45 / 4120 81 / 4120 91

Earth Leakage
Module with integrated
Measurement



4106 57

Cx3 EMS modules:

414919
Single phase



414920
Three phase



414926
Pulse
concentrator

CX3 EMS
signalling and
control modules



414929 / 414930 / 414932

CX3 EMS signalling and
control modules



414931

CX3 + DX3 MCBs



4086 94



4125 56

EMDX³ measuring
units



4120 53



4120 45 / 4120 91
EMDX³ energy
meters

Auxiliaries and
motorised control

+

I/O interface



028815



026144



026136

COMMERCIAL AND INDUSTRIAL



420010

DPX3 MCCBs



028696

DMX3 MCCBs

CX3 EMS
measuring
module



414923

Electronic DPX3
with integrated
measurement



028803

DMX3 with
electronic
Protection unit

Auxiliaries and
motorised controls



028815



026144

+

CX3 EMS
signalling and
control modules



414929 / 414932

COMMUNICATION

REMOTE

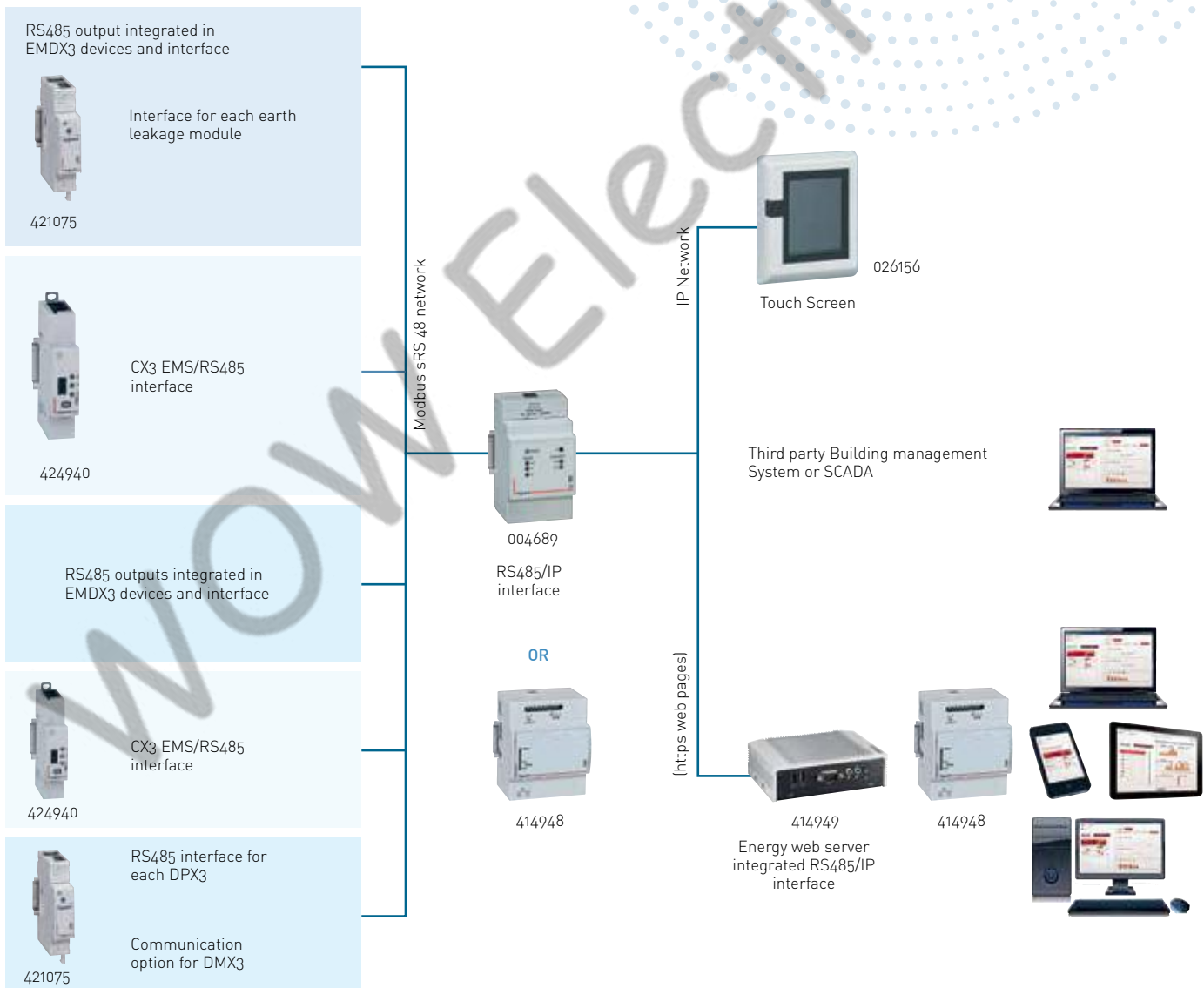

Power Supply

Cat.Nos	Description	MRP* ₹ / Unit	Pack
---------	-------------	------------------	------

Generic Power Supply for all your conversion needs from AC to DC

Features

Conform to standards UL 508, UL 60950, EN 61558-2-16 and IEC EN 60950-1, EN 55022 class B, EN 61000-3-2, EN 61000-3-3, EN 61000-6-2 and EN 61204-3

Operating frequency: 50/60 Hz

Output voltage present indicator

Output voltage adjustment potentiometer on front panel

Integrated short-circuit and overload protection

For mounting on a symmetrical rail depth 7.5 mm and 15 mm

1467 01	Single-phase switching modules power supply - 15 W - input 100-240 V~ / output 5 V=	5494	1
1467 11	Single-phase switching modules power supply - 24 W - input 100-240 V~ / output 12 V=	5952	1

* MRP - Maximum Retail Price Inclusive of all taxes including GST.
(1) Price in Meters; No of meters in Pack, Standard length 2 meters to be ordered in multiple of 2 meters.

Power Supply

Cat.Nos	Description	MRP* ₹ / Unit	Pack
---------	-------------	------------------	------



1467 21

1467 12	Single-phase switching modules power supply - 54 W - input 100-240 V~ / output 12 V=	6578	1
1467 21	Single-phase switching modules power supply - 15 W - input 100-240 V~ / output 24 V=	6130	1
1467 22	Single-phase switching modules power supply - 36 W - input 100-240 V~ / output 24 V=	6180	1
1467 23	Single-phase switching modules power supply - 60 W - input 100-240 V~ / output 24 V=	6754	1
1467 24	Single-phase switching modules power supply - 92 W - input 100-240 V~ / output 24 V=	7304	1

Bold Cat.Nos are products normally available with Legrand (India) Stockists. Cat.Nos that are not bold - delivery within 4 - 8 weeks from the date of order. **Bold packing quantity** is our mandatory packing. Orders to be placed by Legrand (India) Stockist in multiples of the same.

Switching Mode Power Supplies

single-phase

Generic power supply for all your conversion needs from AC to DC

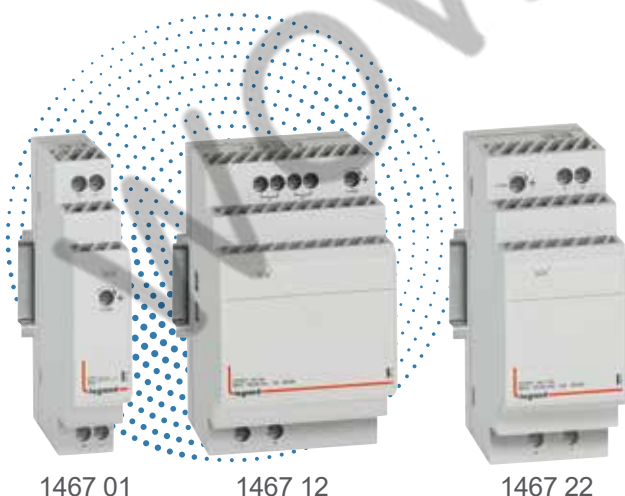

1467 01

1467 12

1467 22

UL 508 approvals

conforming to IES EN 60950-1, EN 61558-2-16

Conforming to EN 55022 class B*, EN 61000-3-2 class A, EN 61000-3-3

Conforming to EN 61000-4-2, 3, 4, 6 Level 3, criterion A

EN 61000-4-5 and 8 level 4, criterion A

EN 61204-3

*Class B means the power supply can be used in any environment, including residential

Features

Operating frequency: 50/60 Hz

Integrated short-circuit and overload protection on the power supply secondary

Class II insulation

Output voltage present indicator

Output voltage adjustment potentiometer on front panel

Output voltage variation: ±1%

No-load power consumption less than 0.3w

Cooling by natural convection

Modular product

EMDX³

SMART
ELECTRICITY
METERS



SUSTAINABLE SAVINGS
FOR YOUR INSTALLATIONS



A meter should be selected according to the network (single-phase or three-phase) and its maximum current, required displayed values and communication type allowing it to be run by a supervision system.

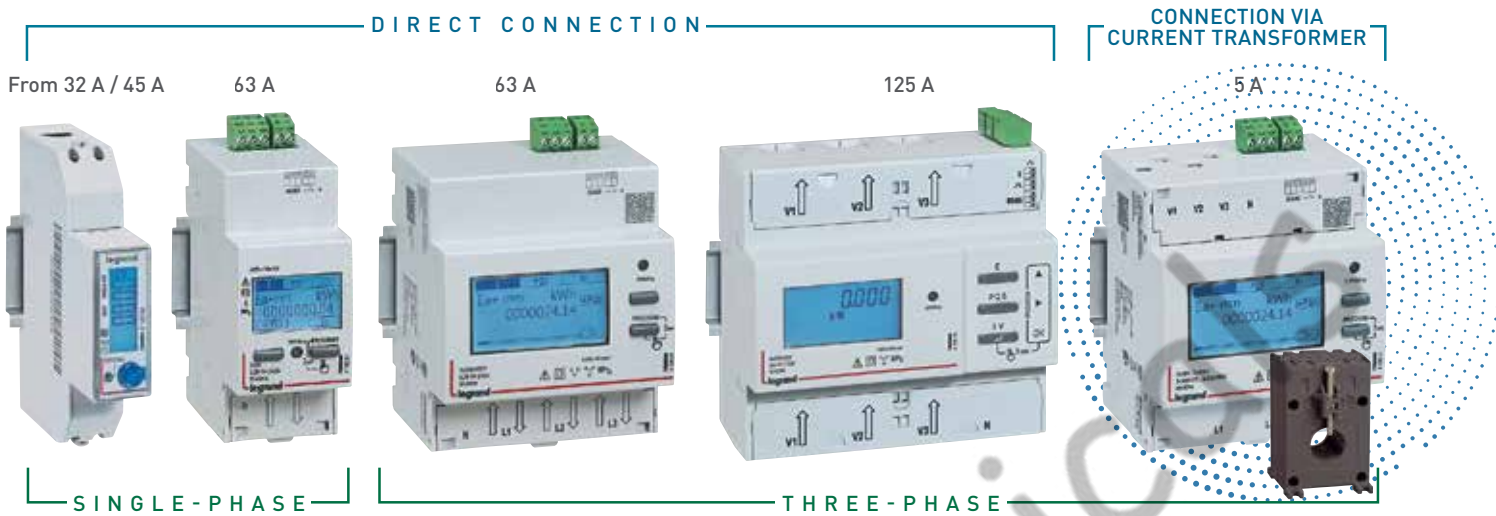

Conforming to standards IEC 61557-12, IEC 62053-21/23, IEC 62052-11, IEC 62052-31, EN 50470-1/3 (for the MID version)

	Cat.No	I _{max} (A)	Width (number of modules)	Non-MID	MID	Output		Dual Tariff	WAGES (Pulse Input)
						Modbus (RS 485)	Pulse		
Single-phase Direct connection	0 046 70	32	1	x			x		
	4 120 68	45	1	x		x			
	4 120 69	45	1		x		x		
	4 120 80	63	2	x			x		x
	4 120 81	63	2	x		x		o	o
	4 120 82	63	2		x		x		x
	4 120 83	63	2		x	x		o	o
Three-phase Direct connection	4 120 90	63	4	x			x		x
	4 120 91	63	4	x		x		o	o
	4 120 92	63	4		x		x		x
	4 120 93	63	4		x	x		o	o
	4 120 74	125	6	x		x	x	x	
	4 120 75	125	6		x	x	x	x	
Three-phase Connection via current transformer	4 120 40	5	4	x			x		x
	4 120 41	5	4	x		x		o	o
	4 120 42	5	4		x		x		x
	4 120 43	5	4		x	x		o	o

New range

Built-in

Dual tariff or 1 pulse input for other meters to connect (water, gas etc.)

The Dual Tariff function allows energy consumption to be measured during different time slots (peak period, off-peak period) or record energy use from two different sources (EB or DG) with a single meter.



Scan to know more about the product.

EMDX³ Multi-function meters for Smart Distribution Board

Din rail mounting

Din Rail Meters for Smart Distribution Board. LCD meter with bright graphical back lit display. 1P / 3P Direct connection or connection with CT. Measures kWh as well as other values like current, voltage, active energy, power etc.

Confirms to Standards: IEC 61557-12; IEC 62053-21/23; IEC 62052-11 and IEC 62052-31

MID* compliance ensures accuracy for billing

Dual Tariff meters

WAGES Enabled (1 Pulse input to connect water meter, gas meter etc.)

*MID - Measuring Instruments Directive. The meters comply to MID, ensures the highest levels of reliability and transparency, and in order to provide complete metrological assurance, applications that necessitate the installation of meters dedicated to invoicing purposes.

Direct Connection Single Phase

Cat. Nos	Current Rating (A)	Description	No. of Modules	MRP* ₹ / Unit	Pack
0046 70	32	32A 1P Energy Meter with Pulse Output	1	■	1
4120 68	45	45A 1P Multi Function Meter with RS-485	1	■	1
4120 69	45	45A 1P Multi Function Meter with Pulse Output - MID	1	■	1
4120 80	63	63A 1P Multi Function Meter with WAGES & Pulse Output	2	■	1
4120 82	63	63A 1P Multi Function Meter with WAGES & Pulse Output - MID	2	■	1
4120 81	63	63A 1P Multi Function Meter with Dual Tariff / WAGES & RS-485	2	■	1
4120 83	63	63A 1P Multi Function Meter with Dual Tariff / WAGES & RS-485 - MID	2	■	1

Direct Connection

Three Phase

4120 90	63	63A 3P Multi Function Meter with WAGES & Pulse Output	4	■	1
4120 92	63	63A 3P Multi Function Meter with WAGES & Pulse Output - MID	4	■	1
4120 91	63	63A 3P Multi Function Meter with Dual Tariff / WAGES & RS-485	4	■	1
4120 93	63	63A 3P Multi Function Meter with Dual Tariff / WAGES & RS-485 - MID	4	■	1
4120 74	125	125A 3P Multi Function Meter with Dual Tariff / WAGES, RS-485 & Pulse Output	6	■	1
4120 75	125	125A 3P Multi Function Meter with Dual Tariff / WAGES, RS-485 & Pulse Output - MID	6	■	1



4120 80



4120 91

EMDX³ Multi-function meters for Smart Distribution Board

Cat. Nos	Current Rating (A)	Description	No. of Modules	MRP* ₹ / Unit	Pack
----------	--------------------	-------------	----------------	---------------	------

Connection with CT

4120 40	5	3P with CT Multi Function Meter with WAGES & Pulse Output	4	■	1
4120 42	5	3P with CT Multi Function Meter with WAGES & Pulse Output - MID	4	■	1
4120 41	5	3P with CT Multi Function Meter with Dual Tariff / WAGES & RS-485	4	■	1
4120 43	5	3P with CT Multi Function Meter with Dual Tariff / WAGES & RS-485 - MID	4	■	1

Modular Multi Function Meter

LCD meter with bright graphical back lit display. 4 Dedicated Keys (V / I / P Q S / E P F F) Precision class 1 / 0.5

Connection with current transformers (CT)

Measurement of currents, voltages, frequency, active, reactive and apparent power, power factor, active and reactive energy

4 tariff metering THD voltages, currents and harmonic analysis up to order 25th (available on Modbus COM port)

Programmable alarms on all functions

RS 485 and pulse output

Phase sequence correction diagnostic

Customized display page

Cat. Nos	Current Rating (A)	Description	No. of Modules	MRP* ₹ / Unit	Pack
----------	--------------------	-------------	----------------	---------------	------

4120 45	5	Modular Multi Function Meter with THD - RS-485 & Pulse Output CI 1	4	■	1
4120 51	5	4 Tariff Modular Multi Function Meter with Individual THD, Programmable alarms - RS-485 & Pulse Output CI 0.5	4	■	1



4120 51



4120 65

Pulse concentrator

For collecting and transmitting measurements taken by 12 universal pulse electricity meters.

Collects pulses from other meters (gas meters, water meters, etc.) RS-485 output

Cat. Nos	Description	No. of Modules	MRP* ₹ / Unit	Pack
----------	-------------	----------------	---------------	------

4120 65	Pulse Concentrator	4	■	1
---------	--------------------	---	---	---

EMDX³ Digital Panel Meter

For mounting on door or solid faceplate

Dimensions: 96 x 96 x 62 mm

LCD meter with bright graphical back lit display.

4 Dedicated Keys (V / I / P Q S / E P F F)

Measurement of currents, voltages, active, reactive and apparent power and power factor

Bold Cat.Nos are products normally available with Legrand (India) Stockists. Cat.Nos that are not bold - delivery within 4 - 8 weeks from the date of order. Bold packing quantity is our mandatory packing. Orders to be placed by Legrand (India) Stockist in multiples of the same.

EMDX³ Digital Panel Meter

Cat. Nos	Description	MRP* ₹ / Unit	Pack
----------	-------------	------------------	------

Metering:

- Active energy consumed or produced
- Reactive energy consumed or produced
- Operating time
- Pulses
- THD voltages, currents, and individual harmonic up to order 25(1)
- RS 485 communication and Pulse output
- Phase sequence correction diagnostic
- Optorelays with potential-free SPST-NO contact
- Customized display page



4120 52

4120 47	Multi Function Meter with THD - RS-485 & Pulse Output CI 1	■	1
4120 52	Advance Multi Function Meter with Individual THD - RS-485 & Pulse Output CI 0.5	■	1

Power Quality & Network Analyzer with Data Logger

Dimensions: 96 x 96 x 62 mm

LCD meter with bright graphical back lit display.

Customized display page

4 Dedicated Keys (V / I / P Q S / E P F F)

Precision class: 0.5

Measurement of currents, voltages, active, reactive and apparent power, internal temperature and power factor

Metering:

- active energy consumed or produced
- Reactive energy consumed or produced
- Operating time
- THD
- Programmable alarms on all functions
- Power quality functions: harmonics (U & I) to 50th, dips, swells, interruption, rapid voltage change and flickers
- Memory embedded (8 Mb)
- RTC (real time clock)
- Can take 4 EMDX3 optional modules



4120 53

Cat. Nos	Description	MRP* ₹ / Unit	Pack
4120 53	Power Quality & Network Analyzer with Data Logger	■	1
4120 55	R485 communication module with Modbus link	■	1
4120 59	2 Pulse output module for energy count	■	1
4120 57	2 inputs / 2 outputs module	■	1
4120 60	2 analog outputs module	■	1
4120 58	Temperature module	■	1



0046 89



4149 38



4149 48

Communication interface

Cat. Nos	Description	MRP* ₹ / Unit	Pack
----------	-------------	------------------	------

RS485 / Ethernet

0046 89	IP converter For RS 485/Ethernet conversion for connecting electricity meters and measurement control units to an IP network	■	1
---------	---	---	---

Energy management software for 1 computer (user licence key)

Allows remote configuration, test, control and visualization of data

30-day free trial version available for download via E-Catalogue

Cat. Nos	Description	MRP* ₹ / Unit	Pack
----------	-------------	------------------	------

4149 38	Software licence agreement (user key) for 32 Modbus addresses or 32 pulse modules	■	1
4149 39	Software licence agreement (user key) 255 Modbus addresses or 255 pulse modules	■	1

Energy management multi-support web servers

Allow remote configuration, test, control and visualization, via a web browser on PCs, smartphones, web viewers, tablet computers, of data

Features

- In-built IP converter
- Power supply: 9 to 28 V= with the help of a single-phase switching mode power supply Cat.No 1 467 21 to be ordered separately
- With the Legrand Power supervision system, circuit breakers are integrated in a supervision system
- You can therefore check the status of the circuit breakers, measure the electrical values and control the circuit breakers remotely
- MODBUS protocol

Cat. Nos	Description	MRP* ₹ / Unit	Pack
----------	-------------	------------------	------

4149 47	For 10 Modbus addresses or 10 pulse modules	■	1
4149 48	For 32 Modbus addresses or 32 pulse modules	■	1
4149 49	For 255 Modbus addresses or 255 pulse modules Supplied with external power supply and fixing" brackets	■	1

Bold Cat.Nos are products normally available with Legrand (India) Stockists. Cat.Nos that are not bold - delivery within 4 - 8 weeks from the date of order. Bold packing quantity is our mandatory packing. Orders to be placed by Legrand (India) Stockist in multiples of the same.

PMX

DIGITAL PANEL METERS

FOR ACCURATE
MONITORING AND
ENERGY SAVINGS.



WHY IS PMX PERFECT FOR YOUR FACILITY?



ROBUST

- ✓ Single function meter to advanced level MFM and demand controllers
- ✓ Ensures accurate wiring with ease
- ✓ Cost effective



ADAPTABLE

- ✓ Universal control power supply
- ✓ Site selectable CT/PT ratios
- ✓ Seamless integration with EMS/SCADA

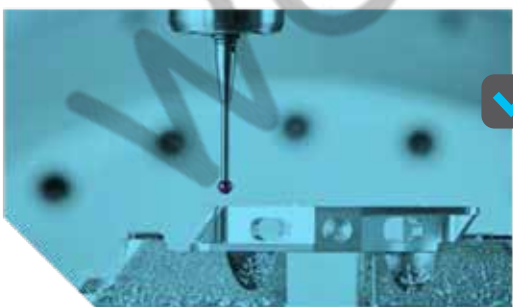

PRECISE

- ✓ True RMS measurement
- ✓ High accuracy class 1 & class 0.5 s
- ✓ Detailed measurements with auto-scaling



Scan to know more about
the product.

PMX Digital Panel Meters

Cat.Nos	Model Series	Description	MRP* ₹ / Unit	Pack
---------	--------------	-------------	------------------	------

PMX 1000 precise single function meters

Features

- **RoHS Compliance**
- True RMS measurement
- High accuracy with class 1 as per IEC 62053-21
- Volts & Amps: $\pm 1.0\%$ of Rated Current.
- **Bright 7 Segment LED display with four digit resolution and 14mm Height**
- Auto and Manual scrolling
- **Site selectable CT/PT ratios**
- Site selectable CT Secondary 1 A/5 A
- **Site selectable 3Phase 4Wire, 3Phase 3Wire & 1Ph configuration**
- Suitable for 50/60 Hz
- Wide range of control power supply 80 - 300 V AC, 40-70 Hz
- Low burden < 0.2 VA per phase Volts & Amps
- Average & Phase wise measurements
- Password protection



4149 77



4149 78

4149 75	PMX 1100	1Ph Ammeter CI 1	1360	1
4149 76	PMX 1200	1Ph Voltmeter CI 1	1360	1
4149 77	PMX 1103	3Ph Ammeter CI 1	1970	1
4149 78	PMX 1203	3Ph Voltmeter CI 1 + Hz	1970	1

PMX 4000 true VAF + PF meter

Features

- **RoHS Compliance**
- **Displays Current, line to neutral & line to line Voltages, frequency & Power Factor. (VA & PF - Phase Wise & Average)**
- **Display on Hours**
- True RMS measurement with simulations sampling of Current & Voltage
- High accuracy with class 1 as per IEC 62053-21 Volts & Amps: $\pm 1.0\%$ of Rated Current.
- **3 Row Display with LED status for different parameter selection.**
- Auto and Manual scrolling
- Site selectable CT/PT ratios
- Site selectable CT Secondary 1 A/5 A
- Site selectable 3Phase 4Wire, 3Phase 3Wire & 1Ph configuration
- Suitable for 50/60 Hz
- Universal control power supply 80 - 300 V AC/DC, 40-70 Hz
- Low burden < 0.2 VA per phase Volts & Amps
- Average & Phase wise measurements
- **Password protection**
- **Seamless integration with EMS/SCADA system with RS485 serial channel communication,**



4149 80



4149 82

PMX Digital Panel Meters

Cat.Nos	Model Series	Description	MRP* ₹ / Unit	Pack
---------	--------------	-------------	------------------	------

Industry standard Modbus RTU protocol.

4149 79	PMX 4000	3Ph VAF + PF meter CI 1	3444	1
4149 80	PMX 4000	3Ph VAF + PF meter CI 1 with RS485	4110	1

PMX 5000

smart energy meters for smart energy billing

Features

- **RoHS Compliance**
- kWh/kVA
- **Old Energy register for back up of last cleared energy values**
- Bright LED with parameter name and value
- Auto scaling capability in adjustment of Kilo, Mega, Giga.
- kWh / kVA / PF / W - any one programmable
- **Positive energy accumulation even with CT polarity reversal with reverse lock program**
- High Accuracy with class 1 as per IEC 62053-21
- Site selectable CT/PT ratios
- Site selectable CT Secondary 1 A/5 A
- Universal control power supply 80 - 300 V AC/DC, 40-70 Hz
- Password protection for tamper proofing
- **Seamless integration with EMS/SCADA system with RS485 serial channel communication, Industry standard Modbus RTU protocol.**
- **Pulse output for integration into a process through PLC/DCS for online energy management**
- Provision for Tamper proofing with meter casing* *optional strip for tamper proofing.

4149 81	PMX 5000	kWh LED meter CI 1	3868	1
4149 82	PMX 5000	kWh LED meter CI 1 with RS485	4462	1
4149 83	PMX 5000	kWh LED meter CI 1 with Pulse Output	5346	1

PMX 6000 multi dual source meter

Features

- **RoHS Compliance**
- **Bright LED display for showing parameters for both EB & DG**
- **Displays full range of parameters Basic : VLL, VLN, A (Avg. & Phase wise), F Power: W, PF (Avg. & Phase wise) Energy: Wh**
- **Load Hours, Run Hours, Old Wh, Old Load Hours for both EB & DG.**
- **DG Sensing input - 230 VAC**
- Auto scaling capability in adjustment of Kilo, Mega, Giga.
- Positive energy accumulation even with CT polarity reversal with reverse lock program.
- High Accuracy with class 1 as per IEC 62053-21 & class 0.5 as per IEC 62053-22

Bold Cat.Nos are products normally available with Legrand (India) Stockists. Cat.Nos that are not bold - delivery within 4 - 8 weeks from the date of order. Bold packing quantity is our mandatory packing. Orders to be placed by Legrand (India) Stockist in multiples of the same.

PMX Digital Panel Meters

Cat.Nos	Model Series	Description	MRP* ₹ / Unit	Pack
---------	--------------	-------------	------------------	------

- Site selectable CT/PT ratios
- Site selectable CT Secondary 1 A/5 A
- Universal control power supply 80 – 300 V AC/DC, 40-70 Hz
- Password protection for tamper proofing
- **Seamless integration with EMS/SCADA system with RS485 serial channel communication, Industry standard Modbus RTU protocol.**
- Provision for Tamper proofing with meter casing*
*optional strip for tamper proofing



4149 85

4149 84	PMX 6000	Dual Source LED meter CI 1 with RS485	6900	1
4149 85	PMX 6000	Dual Source LED meter CI 0.5 with RS485	8146	1

PMX 7000 multifunction meter

Features

- **RoHS Compliance**
- **Bright LED display to view more than 25 parameters.**
- Displays full range of parameters
Basic : VLL, VLN, A (Avg. & Phase Wise), F
Power: W, PF, VA (Avg. & Phase Wise)
Energy: Wh,
- **Load Hours, Run Hours, Old Wh, Old Load Hours**
- Auto scaling capability in adjustment of Kilo, Mega, Giga.
- **Positive energy accumulation even with CT polarity reversal with reverse lock programmable**
- High Accuracy with class 1 as per IEC 62053-21
- Site selectable CT/PT ratios
- Site selectable CT Secondary 1 A/5 A
- Universal control power supply 80 – 300 V AC/DC, 40-70 Hz
- Password protection for tamper proofing
- **Seamless integration with EMS/SCADA system with RS485 serial channel communication, Industry standard Modbus RTU protocol**
- Provision for Tamper proofing with meter casing*
*optional strip for tamper proofing



4149 90



4149 91

4149 90	PMX 7000	MFM (VAF + W/VA/PF/Wh) LED meter CI 1 with RS485 [^]	6672	1
4149 91	PMX 7300	MFM LED meter CI 1	7954	1
4149 92	PMX 7300	MFM LED meter CI 1 with RS485	9490	1

PMX Digital Panel Meters

Cat.Nos	Model Series	Description	MRP* ₹ / Unit	Pack
---------	--------------	-------------	------------------	------

PMX 7400 advance multifunction meter / load manager / demand monitor

Features

- **RoHS Compliance**
- **Advance multifunction meter with High/Low recording of VLL, VLN, A, Hz, PF, Var with time stamp.**
- **Voltage & Current THD (Total Harmonics Distortion) with Individual harmonics up to 31st order.**
- **K-factor V & A to keep check on the losses due to harmonic load currents & their effects on transformer heating.**
- Load manager with demand monitoring
- **RTC based Demand management**
- **Import/Export/Net monitoring of Wh, VAh, VARh Inductive/Capacitive, Load hours**
- Auto scaling capability in adjustment of Kilo, Mega, Giga.
- **Positive energy accumulation even with CT polarity reversal with reverse lock programmable**
- High Accuracy with class 1 as per IEC 62053-21 & class 0.5s as per IEC 62053-22
- Site selectable CT/PT ratios
- Site selectable CT Secondary 1 A/5 A
- Universal control power supply 80-300 V AC/DC, 40-70 Hz
- Password protection for tamper proofing
- **Seamless integration with EMS/SCADA system with RS485 serial channel communication, Industry standard Modbus RTU protocol.**
- Byte order option – Field Programmable Float/ Little Endian/ Big Endian data formats



4149 96

4149 93	PMX 7400	MFM + THD LED meter CI 1 with RS485	12700	1
4149 94	PMX 7400	MFM + THD LED meter CI 0.5 with RS485	15506	1
4149 95	PMX 7410	MFM + THD + Demand monitoring LED meter CI 1 with RS485	18444	1
4149 96	PMX 7420	MFM + THD with Individual + Harmonics + Demand + Import/Export LED meter CI 1 with RS485	19116	1

Bold Cat.Nos are products normally available with Legrand (India) Stockists. Cat.Nos that are not bold - delivery within 4 - 8 weeks from the date of order. Bold packing quantity is our mandatory packing. Orders to be placed by Legrand (India) Stockist in multiples of the same.

PMX Digital Panel Meters

Cat.Nos	Model Series	Description	MRP* ₹ / Unit	Pack
4149 97	PMX 7420	MFM + THD with Individual + Harmonics + Demand + Import/Export LED meter CI 0.5s with RS485	21792	1

PMX 8000 advance demand controller

Features

- **RoHS Compliance**
- **Demand controller with 4 relay output**
- **High memory Data Logger (8MB) for storing multiple parameters.**
- **Predictive demand with date & time stamping**
- **Voltage & Current THD (Total Harmonics Distortion) with Individual harmonics up to 31st order.**
- **K-factor V & A to keep check on the losses due to harmonic load currents & their effects on transformer heating.**
- **Advance multifunction meter with High/Low recording of VLL, VLN, A, Hz, PF, Var with time stamp.**
- **RTC based Demand management**
- **Import/Export/Net monitoring of Wh, VAH, VARh Inductive/Capacitive, Load hours**
- **Auto scaling capability in adjustment of Kilo, Mega, Giga.**
- **Positive energy accumulation even with CT polarity reversal with reverse lock programmable**
- **High Accuracy with class 1 as per IEC 62053-21**
- **Site selectable CT/PT ratios**
- **Site selectable CT Secondary 1 A/5 A**
- **Universal control power supply 80 - 300 V AC/DC, 40-70 Hz**
- **Password protection for tamper proofing**
- **Seamless integration with EMS/SCADA system with RS485 serial channel communication, Industry standard Modbus RTU protocol.**
- **Byte order option - Field Programmable Float/ Little Endian/ Big Endian data formats**



4149 98

4149 98	PMX 8000	Demand Controller CI 1 with data logger + Bi directional + THD with Individual Harmonics	42238	1
---------	-------------	---	-------	---

CTX³ MINI:

AN ULTRA-COMPACT SOLUTION UP TO 16 A



With their compact size, CTX³ MINI are easy to integrate in control panels or distribution boards for switching motors, lighting and heating circuits up to 16 A.



CTX³ MINI: MOUNTING ON DIN RAIL OR ON PLATE

- 1 IP 2X screw terminals
- 2 Integrated auxiliary contact (3P only)
- 3 A1 and A2 supply terminal block



Scan to know more about
the product.

CTX³ RTX³ MPX³

UNCOMPROMISING
PERFORMANCE FOR
MOTOR PROTECTION
AND CONTROL



A COMPLETE RANGE OF DEVICES FOR THE PROTECTION AND CONTROL OF MOTORS

CTX³ CONTACTORS AND RTX³ THERMAL RELAYS UP TO 800 A

- Compact size
- High mechanical and electrical endurance for maximum reliability
- Lowest watt loss
- 3-Pole and 4-pole contactors
- Screw terminals
- Complete range of auxiliaries and accessories

MPX³ MOTOR PROTECTION CIRCUIT BREAKERS UP TO 100 A

- High breaking capacity and type 2 coordination for an optimum service level
- Trip class 10
- Sensitive to phase loss
- Compact size
- Can be fixed on 35 mm DIN rail or using screws
- Easy combination with CTX³ 3-pole contactors
- Complete range of control and signalling auxiliaries and accessories



Scan to know more about
the product.

Mini contactors CTX³ 6 to 16 A industrial contactors

Cat.Nos	Max. opt. current AC 3	Max. opt. current AC 1	Control voltage	MRP* ₹ / Unit	Pack
---------	------------------------	------------------------	-----------------	---------------	------

An Ultra Compact Solution Upto 16A (AC3) 3P & 4P

For Switching Motors, Lighting and Heating Circuits
Ultra High Reliability
Ultra High Endurance
Ultra Low Wattloss

Features

Conforms to IEC/EN 60947-4-1
CE & UL Certified
Range From 6A to 16A AC3
Available in 3P & 4P
Click fit accessories
Ultra Compact design
Front and side add on auxiliary contact
Mechanical Interlock unit
mini Thermal Overload Relay

Spare Coils available

RoHS Compliant

3 pole mini contactors

With integrated auxiliary contact
Power terminals: screw terminals

6 A - Integrated auxiliary contact 1 NO

4170 00	6 A	20 A	24 V~	1388	1
4170 01	6 A	20 A	24 V=	1896	1
4170 04	6 A	20 A	110 V~	1388	1
4170 06	6 A	20 A	230 V~	1388	1
4170 09	6 A	20 A	415 V~	1388	1

6 A - Integrated auxiliary contact 1 NC

4170 10	6 A	20 A	24 V~	1388	1
4170 11	6 A	20 A	24 V=	1896	1
4170 14	6 A	20 A	110 V~	1388	1
4170 16	6 A	20 A	230 V~	1388	1
4170 19	6 A	20 A	415 V~	1388	1

9 A - Integrated auxiliary contact 1 NO

4170 20	9 A	20 A	24 V~	1522	1
4170 21	9 A	20 A	24 V=	2016	1
4170 24	9 A	20 A	110 V~	1522	1
4170 26	9 A	20 A	230 V~	1522	1
4170 29	9 A	20 A	415 V~	1522	1

9 A - Integrated auxiliary contact 1 NC

4170 30	9 A	20 A	24 V~	1522	1
4170 31	9 A	20 A	24 V=	2016	1
4170 34	9 A	20 A	110 V~	1522	1
4170 36	9 A	20 A	230 V~	1522	1
4170 39	9 A	20 A	415 V~	1522	1

12 A - Integrated auxiliary contact 1 NO

4170 40	12 A	20 A	24 V~	1648	1
4170 41	12 A	20 A	24 V=	2468	1
4170 44	12 A	20 A	110 V~	1648	1
4170 46	12 A	20 A	230 V~	1648	1
4170 49	12 A	20 A	415 V~	1648	1

12 A - Integrated auxiliary contact 1 NC

4170 50	12 A	20 A	24 V~	1648	1
4170 51	12 A	20 A	24 V=	2468	1
4170 54	12 A	20 A	110 V~	1648	1
4170 56	12 A	20 A	230 V~	1648	1
4170 59	12 A	20 A	415 V~	1648	1

* MRP - Maximum Retail Price Inclusive of all taxes including GST.

Mini contactors CTX³ 6 to 16 A industrial contactors

Cat.Nos	Max. opt. current AC 3	Max. opt. current AC 1	Control voltage	MRP* ₹ / Unit	Pack
---------	------------------------	------------------------	-----------------	---------------	------

16 A - Integrated auxiliary contact 1 NO

4170 60	16 A	20 A	24 V~	1986	1
4170 61	16 A	20 A	24 V=	2858	1
4170 64	16 A	20 A	110 V~	1986	1
4170 66	16 A	20 A	230 V~	1986	1
4170 69	16 A	20 A	415 V~	1986	1

16 A - Integrated auxiliary contact 1 NC

4170 70	16 A	20 A	24 V~	1986	1
4170 71	16 A	20 A	24 V=	2858	1
4170 74	16 A	20 A	110 V~	1986	1
4170 76	16 A	20 A	230 V~	1986	1
4170 79	16 A	20 A	415 V~	1986	1

4-pole mini contactors

Without integrated auxiliary contact
Power terminals: screw terminals

Cat.Nos	Max. opt. current AC 1	Max. opt. current AC 3	Control voltage	MRP* ₹ / Unit	Pack
---------	------------------------	------------------------	-----------------	---------------	------

20 A

4171 40	20 A	16 A	24 V~	1798	1
4171 41	20 A	16 A	24 V=	2286	1
4171 44	20 A	16 A	110 V~	1798	1
4171 46	20 A	16 A	230 V~	1798	1
4171 49	20 A	16 A	415 V~	1798	1

Mini Thermal Overload Relays RTX³ mini

for mini contactors

Cat.Nos	Setting Range	MRP* ₹ / Unit	Pack
---------	---------------	---------------	------

Features

Conforms to IEC/EN 60947-4-1
CE & UL Certified
Thermal protection of circuits against overload, long starting times, and phase failure
Trip Class 10A
Trip Indication
Manual/Automatic Reset
Integrated auxiliary contacts 1 NO & 1 NC

Thermal overload relays for 3 pole mini contactors

Class 10 A - Integrated auxiliary contacts 1 NO + 1 NC

4170 80	0.1~0.16 A	1602	1
4170 81	0.16~0.25 A	1602	1
4170 82	0.25~0.4 A	1602	1
4170 83	0.4~0.63 A	1602	1
4170 84	0.63~1 A	1602	1
4170 85	1~1.6 A	1602	1
4170 86	1.6~2.5 A	1602	1
4170 87	2.5~4 A	1602	1
4170 88	4~6 A	1602	1
4170 89	5~8 A	1602	1
4170 90	6~9 A	1602	1
4170 91	7~10 A	1602	1
4170 92	9~13 A	1602	1
4170 93	12~16 A	1602	1



4170 88

Bold Cat.Nos are products normally available with Legrand (India) Stockists. Cat.Nos that are not bold - delivery within 4 - 8 weeks from the date of order. Bold packing quantity is our mandatory packing. Orders to be placed by Legrand (India) Stockist in multiples of the same.

Mini Thermal Overload Relays

RTX³ mini

Accessories for mini Contactors CTX³

Cat.Nos	Setting Range	MRP* ₹ / Unit	Pack
---------	---------------	---------------------	------

Add on auxiliary blocks for mini contactors

High Thermal current - 10 A
lth: 10 A

Front mounting

4171 50	1 NO + 1 NC	478	10
4171 51	2 NO	478	10
4171 52	2 NC	478	10
4171 53	4 NO	730	10
4171 54	3 NO + 1 NC	730	10
4171 55	2 NO + 2 NC	730	10
4171 56	1 NO + 3 NC	730	10
4171 57	4 NC	730	10

Side mounting

4171 58	1 NO	474	10
4171 59	1 NC	474	10

Interlock Unit

4171 60	Mechanical interlock for mini contactors	758	5
---------	--	-----	---

Spare coils

4171 70	24 V~	836	5
4171 71	24 V=	1134	5
4171 74	110 V~	836	5
4171 76	230 V~	836	5
4171 79	415 V~	836	5

Power contactors CTX³

Uncompromising Performance for Motor Protection & Control

Range from 9A to 800A (AC3) Contactors

Features

Conforms to IEC/EN 60947-4-1

CE & UL Certified

Extra Mechanical life upto 15 Million

Extra Electrical life upto 2.5 Million

Extra Low Consumption

Compact size

integrated auxiliary contacts

Front safety Cover to prevent dust entry

Direct Clipping on Din Rail

Both Sides Terminal connection

Click fit accessories

Interlocking kits

Spare Coils

RoHS Compliant

3 pole contactors CTX³

9 A to 100 A industrial contactors

Cat.Nos	Max. opt. current AC 3	Max. opt. current AC 1	Control voltage	MRP* ₹ / Unit	Pack
---------	------------------------	------------------------	-----------------	---------------------	------

CTX³ 22

With integrated auxiliary contacts

Power terminals: screw terminals

9 A - Integrated auxiliary contacts 1 NO + 1 NC

4160 80	9 A	25 A	24 V~	1482	1
4160 81	9 A	25 A	24 V=	2448	1
4160 82	9 A	25 A	48 V~	1482	1
4160 83	9 A	25 A	48 V=	2448	1
4160 84	9 A	25 A	110 V~	1482	1
4160 86	9 A	25 A	230 V~	1482	1
4160 88	9 A	25 A	380 V~	1482	1
4160 89	9 A	25 A	415 V~	1482	1

* MRP - Maximum Retail Price Inclusive of all taxes including GST.

3 pole contactors CTX³

9 A to 100 A industrial contactors

Cat.Nos	Max. opt. current AC 3	Max. opt. current AC 1	Control voltage	MRP* ₹ / Unit	Pack
---------	------------------------	------------------------	-----------------	---------------------	------

12 A - Integrated auxiliary contacts 1 NO + 1 NC

4160 90	12 A	25 A	24 V~	1694	1
4160 91	12 A	25 A	24 V=	2646	1
4160 92	12 A	25 A	48 V~	1694	1
4160 93	12 A	25 A	48 V=	2646	1
4160 94	12 A	25 A	110 V~	1694	1
4160 96	12 A	25 A	230 V~	1694	1
4160 98	12 A	25 A	380 V~	1694	1
4160 99	12 A	25 A	415 V~	1694	1

18 A - Integrated auxiliary contacts 1 NO + 1 NC

4161 00	18 A	40 A	24 V~	1988	1
4161 01	18 A	40 A	24 V=	3234	1
4161 02	18 A	40 A	48 V~	1988	1
4161 03	18 A	40 A	48 V=	3234	1
4161 04	18 A	40 A	110 V~	1988	1
4161 06	18 A	40 A	230 V~	1988	1
4161 08	18 A	40 A	380 V~	1988	1
4161 09	18 A	40 A	415 V~	1988	1

22 A - Integrated auxiliary contacts 1 NO + 1 NC

4161 10	22 A	40 A	24 V~	2444	1
4161 11	22 A	40 A	24 V=	4154	1
4161 12	22 A	40 A	48 V~	2444	1
4161 13	22 A	40 A	48 V=	4154	1
4161 14	22 A	40 A	110 V~	2444	1
4161 16	22 A	40 A	230 V~	2444	1
4161 18	22 A	40 A	380 V~	2444	1
4161 19	22 A	40 A	415 V~	2444	1

CTX³ 40

With integrated auxiliary contacts

Power terminals: screw terminals

32 A - Integrated auxiliary contacts 2 NO + 2 NC

4161 20	32 A	50 A	24 V~	5124	1
4161 21	32 A	50 A	24 V=	8878	1
4161 22	32 A	50 A	48 V~	5124	1
4161 23	32 A	50 A	48 V=	8878	1
4161 24	32 A	50 A	110 V~	5124	1
4161 26	32 A	50 A	230 V~	5124	1
4161 28	32 A	50 A	380 V~	5124	1
4161 29	32 A	50 A	415 V~	5124	1

40 A - Integrated auxiliary contacts 2 NO + 2 NC

4161 30	40 A	60 A	24 V~	7590	1
4161 31	40 A	60 A	24 V=	11120	1
4161 32	40 A	60 A	48 V~	7590	1
4161 33	40 A	60 A	48 V=	11120	1
4161 34	40 A	60 A	110 V~	7590	1
4161 36	40 A	60 A	230 V~	7590	1
4161 38	40 A	60 A	380 V~	7590	1
4161 39	40 A	60 A	415 V~	7590	1

CTX³ 65

With integrated auxiliary contacts

50 A - Integrated auxiliary contacts 2 NO + 2 NC

Screw terminals

4161 40	50 A	70 A	24 V~	9294	1
4161 41	50 A	70 A	24 V=	12798	1
4161 42	50 A	70 A	48 V~	9294	1
4161 43	50 A	70 A	48 V=	12798	1
4161 44	50 A	70 A	110 V~	9294	1
4161 46	50 A	70 A	230 V~	9294	1
4161 48	50 A	70 A	380 V~	9294	1
4161 49	50 A	70 A	415 V~	9294	1

Bold Cat.Nos are products normally available with Legrand (India) Stockists. Cat.Nos that are not bold - delivery within 4 - 8 weeks from the date of order. Bold packing quantity is our mandatory packing. Orders to be placed by Legrand (India) Stockist in multiples of the same.



4171 55



4160 96



4161 26



4161 46

3 pole contactors CTX³ 9 A to 100 A industrial contactors

Cat.Nos	Max. opt. current AC 3	Max. opt. current AC 1	Control voltage	MRP* ₹ / Unit	Pack
65 A - Integrated auxiliary contacts 2 NO + 2 NC Screw terminals					
4161 60	65 A	100 A	24 V~	12352	1
4161 61	65 A	100 A	24 V=	14374	1
4161 62	65 A	100 A	48 V~	12352	1
4161 63	65 A	100 A	48 V=	14374	1
4161 64	65 A	100 A	110 V~	12352	1
4161 66	65 A	100 A	230 V~	12352	1
4161 68	65 A	100 A	380 V~	12352	1
4161 69	65 A	100 A	415 V~	12352	1

CTX³ 100

With integrated auxiliary contacts

75 A - Integrated auxiliary contacts 2 NO + 2 NC
Screw terminals

4161 80	75 A	110 A	24 V~	15326	1
4161 81	75 A	110 A	24 V=	17200	1
4161 82	75 A	110 A	48 V~	15326	1
4161 83	75 A	110 A	48 V=	17200	1
4161 84	75 A	110 A	110 V~	15326	1
4161 86	75 A	110 A	230 V~	15326	1
4161 88	75 A	110 A	380 V~	15326	1
4161 89	75 A	110 A	415 V~	15326	1

85 A - Integrated auxiliary contacts 2 NO + 2 NC
Screw terminals

4162 00	85 A	135 A	24 V~	15870	1
4162 01	85 A	135 A	24 V=	18194	1
4162 02	85 A	135 A	48 V~	15870	1
4162 03	85 A	135 A	48 V=	18194	1
4162 04	85 A	135 A	110 V~	15870	1
4162 06	85 A	135 A	230 V~	15870	1
4162 08	85 A	135 A	380 V~	15870	1
4162 09	85 A	135 A	415 V~	15870	1

100 A - Integrated auxiliary contacts 2 NO + 2 NC
Screw terminals

4162 20	100 A	160 A	24 V~	19778	1
4162 21	100 A	160 A	24 V=	22240	1
4162 22	100 A	160 A	48 V~	19778	1
4162 23	100 A	160 A	48 V=	22240	1
4162 24	100 A	160 A	110 V~	19778	1
4162 26	100 A	160 A	230 V~	19778	1
4162 28	100 A	160 A	380 V~	19778	1
4162 29	100 A	160 A	415 V~	19778	1

3 pole contactors CTX³ 130 A to 800 A industrial contactors

CTX 150

With integrated auxiliary contacts

130 A - Integrated auxiliary contacts 2 NO + 2 NC
Screw terminals

4162 40	130 A	160 A	24 V~	29410	1
4162 41	130 A	160 A	24 V=	32306	1
4162 42	130 A	160 A	48 V~	29410	1
4162 43	130 A	160 A	48 V=	32306	1
4162 46	130 A	160 A	100-240 V~/=	29410	1
4162 49	130 A	160 A	400-440 V~	29410	1

150 A - Integrated auxiliary contacts 2 NO + 2 NC
Screw terminals

4162 60	150 A	210 A	24 V~	29810	1
4162 61	150 A	210 A	24 V=	31882	1
4162 62	150 A	210 A	48 V~	29810	1
4162 63	150 A	210 A	48 V=	31882	1

* MRP - Maximum Retail Price Inclusive of all taxes including GST.

3 pole contactors CTX³ 130 A to 800 A industrial contactors

Cat.Nos	Max. opt. current AC 3	Max. opt. current AC 1	Control voltage	MRP* ₹ / Unit	Pack
150 A - Integrated auxiliary contacts 2 NO + 2 NC Screw terminals					
4162 66	150 A	210 A	100-240 V~/=	29810	1
4162 69	150 A	210 A	400-440 V~	29810	1

CTX³ 225

With integrated auxiliary contacts - Screw terminals

185 A - Integrated auxiliary contacts 2 NO + 2 NC

4162 80	185 A	230 A	24 V~/=	37628	1
4162 82	185 A	230 A	48 V~/=	37628	1
4162 86	185 A	230 A	100-240 V~/=	33924	1
4162 89	185 A	230 A	380-450 V~	33924	1

225 A - Integrated auxiliary contacts 2 NO + 2 NC

4162 90	225 A	275 A	24 V~/=	38834	1
4162 92	225 A	275 A	48 V~/=	38834	1
4162 96	225 A	275 A	100-240 V~/=	34332	1
4162 99	225 A	275 A	380-450 V~	34332	1

CTX³ 400

With integrated auxiliary contacts - Screw terminals

265 A - Integrated auxiliary contacts 2 NO + 2 NC

4163 06	265 A	300 A	100-240 V~/=	45024	1
4163 09	265 A	300 A	380-450 V~	45024	1

330 A - Integrated auxiliary contacts 2 NO + 2 NC

4163 16	330 A	350 A	100-240 V~/=	52505	1
4163 19	330 A	350 A	380-450 V~	52502	1

400 A - Integrated auxiliary contacts 2 NO + 2 NC

4163 26	400 A	450 A	100-240 V~/=	64236	1
4163 29	400 A	450 A	380-450 V~	64236	1

CTX³ 800

With integrated auxiliary contacts - Screw terminals

500 A - Integrated auxiliary contacts 2 NO + 2 NC

4163 36	500 A	580 A	200-240 V~/=	96516	1
4163 39	500 A	580 A	380-450 V~	96516	1

630 A - Integrated auxiliary contacts 2 NO + 2 NC

4163 46	630 A	660 A	200-240 V~/=	137438	1
4163 49	630 A	660 A	380-450 V~	137438	1

800 A - Integrated auxiliary contacts 2 NO + 2 NC

4163 56	800 A	900 A	200-240 V~/=	204956	1
4163 59	800 A	900 A	380-450 V~	204956	1

Bold Cat.Nos are products normally available with Legrand (India) Stockists. Cat.Nos that are not bold - delivery within 4 - 8 weeks from the date of order. Bold packing quantity is our mandatory packing. Orders to be placed by Legrand (India) Stockist in multiples of the same.



4161 86



4162 96



4162 46



4163 56

Thermal relays RTX³

for CTX³ 3 pole industrial contactors

Cat.Nos	I min. (A)	I max. (A)	MRP* ₹ / Unit	Pack
---------	---------------	---------------	---------------------	------

Features

Conforms to IEC/EN 60947-4-1

CE & UL Certified

Thermal protection of circuits against overload, long starting times, and phase failure

Trip Class 10A

Trip Indication

Manual/Automatic Reset

Integrated auxiliary contacts 1 NO & 1 NC

Standard type:

- Overload detecting bimetal is used all for three phases

Differential type:

- Standard type characteristics + phase failure protection

Thermal overload relays

Class 10A - Integrated auxiliary contacts 1 NO + 1 NC

RTX³ 40 - for CTX³ 22 and 40

Standard type with screw terminals

4166 40	0.1	0.16	1998	1
4166 41	0.16	0.25	1998	1
4166 42	0.25	0.4	1998	1
4166 43	0.4	0.63	1998	1
4166 44	0.63	1	1998	1
4166 45	1	1.6	1998	1
4166 46	1.6	2.5	1998	1
4166 47	2.5	4	1998	1
4166 48	4	6	1998	1
4166 49	5	8	1998	1

RTX³ 40 - for CTX³ 22 and 40

Standard type with screw terminals

4166 50	6	9	1998	1
4166 51	7	10	1998	1
4166 52	9	13	1998	1
4166 53	12	18	1998	1
4166 54	16	22	2092	1
4166 55	18	25	2116	1
4166 56	22	32	2402	1
4166 57	28	40	2586	1



4167 31



4167 65

Thermal relays RTX³

for CTX³ 3 pole industrial contactors

Cat.Nos	I min. (A)	I max. (A)	MRP* ₹ / Unit	Pack
---------	---------------	---------------	---------------------	------

RTX³ 40 - for CTX³ 22 and 40

Differential type with screw terminals

4166 60	0.1	0.16	2438	1
4166 61	0.16	0.25	2438	1
4166 62	0.25	0.4	2438	1
4166 63	0.4	0.63	2462	1
4166 64	0.63	1	2462	1
4166 65	1	1.6	2462	1
4166 66	1.6	2.5	2462	1
4166 67	2.5	4	2462	1
4166 68	4	6	2472	1
4166 69	5	8	2472	1
4166 70	6	9	2472	1
4166 71	7	10	2472	1
4166 72	9	13	2472	1
4166 73	12	18	2588	1
4166 74	16	22	2588	1
4166 75	18	25	2588	1
4166 76	22	32	3160	1
4166 77	28	40	3160	1

RTX³ 65 - for CTX³ 65

Standard type with screw terminals

4166 83	9	13	4016	1
4166 84	12	18	4016	1
4166 85	16	22	4016	1
4166 86	18	25	4016	1
4166 87	24	36	4016	1
4166 88	28	40	4016	1
4166 89	34	50	4016	1
4166 90	45	65	4016	1

RTX³ 100 - for CTX³ 100

Standard type with screw terminals

4167 23	18	25	6506	1
4167 24	24	36	6506	1
4167 25	28	40	6506	1
4167 26	34	50	6506	1
4167 27	45	65	6506	1
4167 28	54	75	6506	1
4167 29	63	85	6506	1
4167 30	70	95	6506	1
4167 31	80	100	6506	1

RTX³ 150 - for CTX³ 150

Standard type with screw terminals

4167 60	45	65	9568	1
4167 61	54	75	9568	1
4167 62	63	85	9568	1
4167 63	80	105	9568	1
4167 64	95	130	9568	1
4167 65	110	150	9568	1

* MRP - Maximum Retail Price Inclusive of all taxes including GST.

Bold Cat.Nos are products normally available with Legrand (India) Stockists. Cat.Nos that are not bold - delivery within 4 - 8 weeks from the date of order. Bold packing quantity is our mandatory packing. Orders to be placed by Legrand (India) Stockist in multiples of the same.

Thermal relays RTX³

for CTX³ 3 pole industrial contactors

Cat.Nos	Description	MRP* ₹ / Unit	Pack
---------	-------------	------------------	------

Separate mounting units

To mount the relays separately from contactors, on DIN rail or panel by fixing screws

4165 91	For RTX ³ 40 up to 32 A	750	1
4165 92	For RTX ³ 40 40 A	750	1
4165 93	For RTX ³ 65 with screw terminals	926	1
4165 94	For RTX ³ 65 with cage terminals	926	1
4165 95	For RTX ³ 100 with screw terminals	1176	1
4165 96	For RTX ³ 100 with cage terminals	1176	1
4165 97	For RTX ³ 150 with screw terminals	1856	1
4165 98	For RTX ³ 150 with cage terminals	1856	1

Thermal overload relays

Class 10 A - Integrated auxiliary contacts 1 NO + 1 NC

Cat.Nos	I min. (A)	I max. (A)	MRP* ₹ / Unit	Pack
---------	------------	------------	------------------	------

RTX³ 225 - for CTX³ 225

Differential type with screw terminals

4167 80	65	100	13014	1
4167 81	85	125	13014	1
4167 82	100	160	14424	1
4167 83	120	185	14424	1
4167 84	160	240	14982	1



4167 84

RTX³ 400 - for CTX³ 400

Differential type with screw terminals

4167 86	85	125	19100	1
4167 87	100	160	19100	1
4167 88	120	185	19100	1
4167 89	160	240	19100	1
4167 90	200	330	19100	1
4167 91	260	400	19100	1

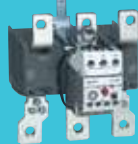

4167 91

RTX³ 800 - for CTX³ 800

Differential type with screw terminals

4167 92	200	300	29704	1
4167 93	260	400	29704	1
4167 94	400	630	29704	1
4167 95	520	800	29704	1



4164 36

4-pole contactors CTX³

40 A to 900 A industrial contactors and spare coils

Cat.Nos	Max. opt. current AC 1	Max. opt. current AC 3	Control voltage	MRP* ₹ / Unit	Pack
---------	------------------------	------------------------	-----------------	------------------	------

Contactors CTX³

Power terminals: screw terminals

Without integrated auxiliary contact

4164 26	40 A	22 A	230 V~	3220	1
4164 36	60 A	40 A	230 V~	8008	1
4164 46	100 A	65 A	230 V~	13762	1
4164 56	135 A	85 A	230 V~	16926	1



4164 56

* MRP - Maximum Retail Price Inclusive of all taxes including GST.

4-pole contactors CTX³

40 A to 900 A industrial contactors and spare coils

Cat.Nos	Max. opt. current AC 1	Max. opt. current AC 3	Control voltage	MRP* ₹ / Unit	Pack
---------	------------------------	------------------------	-----------------	------------------	------

With integrated auxiliary contacts

Auxiliary contacts: 2 NO + 2 NC

4164 66	165 A	130 A	100-240 V~/=	28044	1
4164 76	250 A	150 A	100-240 V~/=	37676	1
4164 86	330 A	225 A	100-240 V~/=	41932	1
4164 96	420 A	330 A	100-240 V~/=	77532	1
4165 06	500 A	400 A	100-240 V~/=	84836	1
4165 16	750 A	630 A	200-240 V~/=	170538	1
4165 26	900 A	800 A	200-240 V~/=	206170	1



4164 86

Spare coils for CTX³ 4P contactors

Cat.Nos	Description	MRP* ₹ / Unit	Pack
---------	-------------	------------------	------

Control voltage 230 V~

4165 46	For CTX ³ 40 A to 60 A (AC-1)	1578	1
4165 56	For CTX ³ 100 A to 135 A (AC-1)	1876	1
4165 66	For CTX ³ 165 A to 330 A (AC-1)	9858	1
4165 76	For CTX ³ 420 A to 500 A (AC-1)	18400	1
4165 86	For CTX ³ 750 A to 900 A (AC-1)	27602	1

CTX³ add-on auxiliary contact blocks

Front mounting

For CTX³ 3P form 9 A to 150 A (AC-3) and CTX³ 4P from 40 A to 135 A (AC-1) - 2 and 4 pole - lth: 16 A

4168 50	1 NO + 1 NC	492	10
4168 51	2 NO	492	10
4168 52	2 NC	492	10
4168 53	4 NO	784	10
4168 54	3 NO + 1 NC	784	10
4168 55	2 NO + 2 NC	784	10
4168 56	1 NO + 3 NC	784	10
4168 57	4 NC	784	10



4168 50



4168 55

Side mounting

2 pole - Mounting on both sides

4168 58	For CTX ³ 3P Form 9 A to 150 A (AC-3) 1 NO + 1 NC - lth: 16 A	868	10
4168 59	For CTX ³ 3P Form 185 A to 800 A (AC-3) and CTX ³ 4P from 165 A to 900 A (AC-1) 1 NO + 1 NC - lth: 16 A	868	10
4168 49	For CTX ³ 4P From 40 A to 135 A (AC-1) 1 NO + 1 NC - lth: 16 A	868	10

Bold Cat.Nos are products normally available with Legrand (India) Stockists. Cat.Nos that are not bold - delivery within 4 - 8 weeks from the date of order. Bold packing quantity is our mandatory packing. Orders to be placed by Legrand (India) Stockist in multiples of the same.

4-pole contactors CTX³

40 A to 900 A industrial contactors and spare coils



Cat.Nos	Description	MRP* ₹ / Unit	Pack
---------	-------------	------------------	------

CTX³ time delay blocks

For CTX³ 3P from 9 A to 150 A (AC-3)

Time delay: 1 to 30 s

Front mounting

On delay

4168 70	24-48 V~/=	2300	1
4168 71	110-230 V~	2300	1

Off delay

4168 72	24-48 V~/=	3156	1
4168 73	110-230 V~	3156	1

CTX³

capacitor switching units Cat.Nos 4168 74/75/76/77

Capacitor unit is connected to the terminals of the contactor to reduce the high inrush current.

IEC 60947-4-1 AC 6b

Type	Contactor		Maximum operating power (kVAR)			Max. Peak current (A)
			220 - 240 V	400 - 480 V	500 - 550 V	
4168 74	CTX ³ 22	9 A	5	9.7	14	560
	CTX ³ 22	12 A	6.7	12.5	18	560
	CTX ³ 22	18 A	8.5	16.7	24	850
	CTX ³ 22	22 A	10	18	26	1250
	CTX ³ 40	32 A	15	25	36	1900
4168 75/76	CTX ³ 40	40 A	20	33.3	48	2160
	CTX ³ 65	50 A	20	40	58	2160
4168 77	CTX ³ 65	65 A	25	45.7	66	3040
	CTX ³ 100	75 A	29.7	54	78	3040
	CTX ³ 100	85 A	35	60	92	3040
Without Capacitor Switching Unit as per IEC 60947-4-1 AC 6b	CTX ³ 100	100 A	37	62	94	3040
	CTX ³ 150	150 A		70		3300
	CTX ³ 225	185 A		84	120	3500
	CTX ³ 225	225 A		115	130	4000
	CTX ³ 400	265 A		125	140	5000
	CTX ³ 400	330 A		139	185	6500
	CTX ³ 400	400 A		185	195	8000
	CTX ³ 800	500 A		220	330	10000
	CTX ³ 800	630 A		291	340	12000
CTX ³ 800	800 A		369	370	14200	

Note:

- When the switch is closed capacitor must be discharged before recharged. (Maximum residual voltage at terminals ≤ 50 V)
- To prevent short current, gG type fuse must be 1.5 - 2 times than rated current

CTX³ accessories

CTX³ capacitor switching units

AC-6b

Operating power from 9.7 kVAR to 62 kVAR (400/440 V)

4168 74	For contactors CTX ³ 3P from 9 to 40 A, upto 33.3 kVAR at 440 V / 48 kVAR at 525 V	2188	1
---------	---	------	---

* MRP - Maximum Retail Price Inclusive of all taxes including GST.

CTX³ accessories

Cat.Nos	Description	MRP* ₹ / Unit	Pack
---------	-------------	------------------	------

CTX³ capacitor switching units

4168 75	For contactors CTX ³ 3P 50 and 65 A with screw terminals upto 45.7 kVAR at 440 V / 66 kVAR at 525 V	2980	1
4168 76	For contactors CTX ³ 3P 50 and 65 A with cage terminals upto 45.7 kVAR at 440 V / 66 kVAR at 525 V	3222	1
4168 77	For contactors CTX ³ 3P 75 to 100 A with screw terminals upto 62 kVAR at 440 V / 94 kVAR at 525 V	3222	1

CTX³ interlocking

Component parts for assembling by customer

Horizontal mounting

Interlock units

4168 79	Mechanical interlocks for CTX ³ 4P from 40 to 135 A (AC-1)	1314	5
---------	---	------	---

Interlock units

4168 80	Mechanical interlocks for CTX ³ 3P from 9 to 150 A Provides 2 NC contacts for use in electrical interlocking	2652	1
4168 87	Mechanical interlocks for CTX ³ 3P from 185 to 400 A and CTX ³ 4P from 165 to 500 A	4600	1

Interlock units

4168 88	Mechanical interlocks for CTX ³ 3P from 500 to 800 A	6158	1
4168 89	Mechanical interlocks for CTX ³ 4P from 750 to 900 A	6502	1

Wire kits

Used for making reversing between two 3P contactors

4168 82	For CTX ³ 22	1340	5
4168 83	For CTX ³ 40	1812	5
4168 84	For CTX ³ 65	2234	5
4168 85	For CTX ³ 100	3738	5

Bold Cat.Nos are products normally available with Legrand (India) Stockists. Cat.Nos that are not bold - delivery within 4 - 8 weeks from the date of order. **Bold packing quantity** is our mandatory packing. Orders to be placed by Legrand (India) Stockist in multiples of the same.

CTX³ accessories



4168 91

Cat.Nos	Description	MRP* ₹ / Unit	Pack
---------	-------------	------------------	------

Boxes for motor starter

For CTX³ 22 equipped with RTX³ 40 (0.1 - 22 A)

4168 90	Without pushbuttons	3408	1
4168 91	With pushbuttons	4180	1

CTX³ transient voltage suppressor blocks

Absorbs the surge arisen out of the coil of the contactor



4168 97

4168 95	24-48 V~/=	656	10
4168 96	100-125 V~/=	656	10
4168 97	200-240 V~/=	656	10
4168 98	380-400 V~	656	10

CTX³ terminals covers

4168 42	For CTX ³ 3P from 185 to 225 A (AC-3)	602	5
4168 43	For CTX ³ 3P from 265 to 400 A (AC-3)	896	5
4168 44	For CTX ³ 3P from 500 to 900 A (AC-3)	1348	5
4168 45	For CTX ³ 4P from 165 to 330 A (AC-1)	752	5
4168 46	For CTX ³ 4P from 420 to 500 A (AC-1)	1138	5
4168 47	For CTX ³ 4P from 750 to 900 A (AC-1)	1920	5



4168 40

CTX³ safety front cover

4168 40	For CTX ³ 3P from 9 to 150 A (AC-3) and CTX ³ 4P from 40 to 135 A (AC-1)	38	50
4168 41	For CTX ³ 3P from 85 to 800 A (AC-3) and CTX 4P from 165 to 900 A (AC-1)	152	50

Distant reset flexible cables for thermal relays

4168 92	400 mm	1126	1
4168 93	500 mm	1222	1
4168 94	600 mm	1242	1

CTX³ spare coils

Spare coils for CTX³ 3P contactors

For CTX³ 22

4169 00	24 V~	846	5
4169 02	48 V~	846	5
4169 04	110 V~	846	5
4169 06	230 V~	846	5
4169 08	380 V~	846	5
4169 09	415 V~	846	5

* MRP - Maximum Retail Price Inclusive of all taxes including GST.

CTX³ accessories

Cat.Nos	Description	MRP* ₹ / Unit	Pack
---------	-------------	------------------	------

For CTX³ 40

4169 20	24 V~	846	5
4169 21	24 V=	846	5
4169 22	48 V~	846	5
4169 23	48 V=	846	5
4169 24	110 V~	846	5
4169 26	230 V~	846	5
4169 28	380 V~	846	5
4169 29	415 V~	846	5

For CTX³ 65

4169 30	24 V~	1304	5
4169 31	24 V=	1304	5
4169 32	48 V~	1304	5
4169 33	48 V=	1304	5
4169 34	110 V~	1304	5
4169 36	230 V~	1304	5
4169 38	380 V~	1304	5
4169 39	415 V~	1304	5

For CTX³ 100

4169 40	24 V~	1592	3
4169 41	24 V=	1592	3
4169 42	48 V~	1592	3
4169 43	48 V=	1592	3
4169 44	110 V~	1592	3
4169 46	230 V~	1592	3
4169 48	380 V~	1592	3
4169 49	415 V~	1592	3

For CTX³ 150

4169 50	24 V~	6020	1
4169 51	24 V=	6020	1
4169 52	48 V~	6020	1
4169 53	48 V=	6020	1
4169 56	100-240 V~/=	6020	1
4169 59	400-440 V~	6020	1

Bold Cat.Nos are products normally available with Legrand (India) Stockists. Cat.Nos that are not bold - delivery within 4 - 8 weeks from the date of order. Bold packing quantity is our mandatory packing. Orders to be placed by Legrand (India) Stockist in multiples of the same.

Auxillary Contactor / Control relays CTX³

Accessories for Auxiliary Contactor / Control Relays



4169 66

Cat.Nos	Description	MRP* ₹ / Unit	Pack
---------	-------------	------------------	------

For CTX³ 225

4169 60	24 V~/=	8702	1
4169 62	48 V~/=	8702	1
4169 66	100-240 V~/=	8702	1
4169 69	400-440 V~	8702	1

For CTX³ 400

4169 76	100-240 V~/=	13088	1
4169 79	380-450 V~	13088	1

For CTX³ 800

4169 86	200-240 V~/=	28494	1
4169 89	380-450 V~	28494	1

Auxillary Contactor / Control relays CTX³

4 pole

Conform to IEC 60 947-1, IEC 60 947-4-1 and IEC 60 947-5-1 for the auxiliary contacts

CE & UL Certified

Ultra High Ith = 10 A

Ultra Low consumption coil

Click fit accessories

Spare Coils available

RoHS Compliant

CTX³ control relays

4 NO

4168 00	24 V~	1708	1
4168 01	24 V=	2588	1
4168 02	48 V~	1708	1
4168 03	48 V=	2588	1
4168 04	110 V~	1708	1
4168 06	230 V~	1708	1
4168 09	415 V~	1708	1

3 NO + 1 NC

4168 10	24 V~	1708	1
4168 11	24 V=	2588	1
4168 12	48 V~	1708	1
4168 13	48 V=	2588	1
4168 14	110 V~	1708	1
4168 16	230 V~	1708	1
4168 19	415 V~	1708	1

Cat.Nos	Description	MRP* ₹ / Unit	Pack
---------	-------------	------------------	------

2 NO + 2 NC

4168 20	24 V~	1708	1
4168 21	24 V=	2612	1
4168 22	48 V~	1708	1
4168 23	48 V=	2588	1
4168 24	110 V~	1708	1
4168 26	230 V~	1708	1
4168 29	415 V~	1708	1

High Thermal current - 10 A

Ith : 10 A

Front mounting

4171 50	1 NO + 1 NC	478	10
4171 51	2 NO	478	10
4171 52	2 NC	478	10
4171 53	4 NO	730	10
4171 54	3 NO + 1 NC	730	10
4171 55	2 NO + 2 NC	730	10
4171 56	1 NO + 3 NC	730	10
4171 57	4 NC	730	10

Side mounting

4171 58	1 NO	474	10
4171 59	1 NC	474	10

Interlock Unit

4171 60	Mechanical interlock	758	5
---------	----------------------	-----	---

Spare coils

4171 70	24 V~	836	5
4171 71	24 V=	1134	5
4171 74	110 V~	836	5
4171 76	230 V~	836	5
4171 79	415 V~	836	5

Bold Cat.Nos are products normally available with Legrand (India) Stockists. Cat.Nos that are not bold - delivery within 4 - 8 weeks from the date of order. **Bold packing quantity** is our mandatory packing. Orders to be placed by Legrand (India) Stockist in multiples of the same.



4168 10

* MRP - Maximum Retail Price Inclusive of all taxes including GST.

CX³

Modular Power Contactors for your switching needs



412544



412556

- Manual handle for permanent OFF / ON
- Manual Override for test & Repair
- Confirms to IEC 61095 & IEC 60947 -4-1
- RoHs Compliance



Scan to know more about the product.

CX³ contactors

Cat.Nos	Description	MRP* ₹ / Unit	Pack
---------	-------------	------------------	------

Power contactors CX³

Conform to IEC/EN 61095
Space for power supply busbar on top (up to 25 A)

4125 44	25 A 2 NO contactor	2502	1
4125 45	40 A 2 NO contactor	4274	1
4125 47	63 A 2 NO contactor	4972	1
4125 48	63 A 2 NC contactor	4972	1
4125 49	40 A 3 NO contactor	7146	1
4125 50	63 A 3 NO contactor	8080	1
4125 51	25 A 4 NO contactor	2952	1
4125 53	40 A 4 NO contactor	7542	1
4125 56	63 A 4 NO contactor	8930	1
4125 57	63 A 4 NC contactor	9014	1

Signalling auxiliaries for contactors

Auxiliary changeover switch

4124 29	For 1 module contactors 16 A to 25 A	3668	1
4124 30	For 2 module contactors 25 A	3680	1
4124 31	For 40 and 63 A contactors	4830	1

* MRP - Maximum Retail Price Inclusive of all taxes including GST.



4173 08

MPCBs MPX³

Cat.Nos	Rated 3Ph Motor	Magnetic release operating current (A)	MRP* ₹ / Unit	Pack
---------	-----------------	--	------------------	------

motor protection circuit breakers from 0.16 A to 100 A upto 45 KW

Maximum efficiency in a compact unit

Conform to IEC 60947-1, IEC 60947-2, IEC 60947-4

Adjustable thermal release

Magnetic release 13 le max

High breaking capacity

toggle handle

Fixing on rail or by screw

Wide range of accessories

Undervoltage Release

Shunt Release

Auxillary Contacts

IP 65 Enclosure

Thermal magnetic MPCBs

Adjustable thermal release Magnetic release 13 le max.

MPX³ 32S - 3P

Standard breaking capacity with toggle handle

Fixing on rail

415 V breaking capacity Icu (kA) - 100

Cat.Nos	Rated 3Ph Motor (KW)	Thermal release adj. range (A)	Magnetic release operating current (A)	MRP* ₹ / Unit	Pack
---------	----------------------	--------------------------------	--	------------------	------

4173 00	0.02	0.1 to 0.16	2.1	3944	1
4173 01	0.06	0.16 to 0.25	3.3	3944	1
4173 02	0.09	0.25 to 0.4	5.2	3944	1
4173 03	0.12	0.4 to 0.63	8.2	4582	1
4173 04	0.18 / 0.25	0.63 to 1	13	4582	1
4173 05	0.37 / 0.55	1 to 1.6	20.8	4614	1
4173 06	0.75	1.6 to 2.5	32.5	4700	1
4173 07	1.5	2.5 to 4	52	4772	1
4173 08	2.2	4 to 6	78	4794	1
4173 09	3	5 to 8	104	4794	1

415 V breaking capacity Icu (kA) - 50

4173 10	4	6 to 10	130	4794	1
4173 11	5.5	9 to 13	169	4844	1

415 V breaking capacity Icu (kA) - 20

4173 12	7.5	11 to 17	221	5696	1
---------	-----	----------	-----	------	---

415 V breaking capacity Icu (kA) - 15

4173 13	7.5	14 to 22	286	6044	1
4173 14	11	18 to 26	338	6506	1
4173 15	15	22 to 32	416	10810	1

Bold Cat.Nos are products normally available with Legrand (India) Stockists. Cat.Nos that are not bold - delivery within 4 - 8 weeks from the date of order. Bold packing quantity is our mandatory packing. Orders to be placed by Legrand (India) Stockist in multiples of the same.

MPCBs MPX³

Cat.Nos	Description	MRP* ₹ / Unit	Pack
---------	-------------	---------------------	------

MPX³ 32H - 3P

High breaking capacity with rotary handle
415 V breaking capacity Icu (kA) - 100

4173 20	0.02	0.1 to 0.16	2.1	4868	1
4173 21	0.06	0.16 to 0.25	3.3	4868	1
4173 22	0.09	0.25 to 0.4	5.2	4868	1
4173 23	0.12	0.4 to 0.63	8.2	5336	1
4173 24	0.18 / 0.25	0.63 to 1	13	5336	1
4173 25	0.37/ 0.55	1 to 1.6	20.8	5336	1
4173 26	0.75	1.6 to 2.5	32.5	5336	1
4173 27	1.5	2.5 to 4	52	5502	1
4173 28	2.2	4 to 6	78	5526	1
4173 29	3	5 to 8	104	5972	1
4173 30	4	6 to 10	130	6028	1
4173 31	5.5	9 to 13	169	6622	1

415 V breaking capacity Icu (kA) - 50

4173 32	7.5	11 to 17	221	7088	1
4173 33	7.5	14 to 22	286	8290	1
4173 34	11	18 to 26	338	8368	1
4173 35	15	22 to 32	416	12988	1

MPX³ 63H - 3P

High breaking capacity with rotary handle
Fixing on rail or by screw
415 V breaking capacity Icu (kA) - 100

4173 60	4	6 to 10	130	12610	1
4173 61	5.5	9 to 13	169	12610	1

415 V breaking capacity Icu (kA) - 50

4173 62	7.5	11 to 17	221	12610	1
4173 63	7.5	14 to 22	286	14292	1
4173 64	11	18 to 26	338	14292	1
4173 65	15	22 to 32	416	14292	1
4173 66	18.5	28 to 40	520	15974	1
4173 67	22	34 to 50	650	19620	1
4173 68	30	45 to 63	819	20932	1

MPX³ 100H - 3P

High breaking capacity with rotary handle
Fixing on rail or by screw
415 V breaking capacity Icu (kA) - 100

4173 70	7.5	11 to 17	221	17430	1
4173 71	7.5	14 to 22	286	17430	1
4173 72	11	18 to 26	338	17430	1



4173 79



4173 48

MPCBs MPX³

Cat.Nos	Description	MRP* ₹ / Unit	Pack
---------	-------------	---------------------	------

Used to connect MPX³ directly with the contactor

4173 73	15	22 to 32	416	17430	1
4173 74	18.5	28 to 40	520	17430	1
4173 75	22	34 to 50	650	20714	1
4173 76	30	45 to 63	819	21718	1

415 V breaking capacity Icu (kA) - 75

4173 77	37	55 to 75	975	23350	1
4173 78	45	70 to 90	1170	23350	1
4173 79	45	80 to 100	1300	23350	1

Magnetic only MPCBs

Without thermal release
Magnetic release 13 x Ie max.

MPX³ 32MA - 3P

High breaking capacity with rotary handle
Fixing on rail
415 V breaking capacity Icu (kA) - 100

4173 40	0.02	2.1	4460	1
4173 41	0.06	3.3	4460	1
4173 42	0.09	5.2	4460	1
4173 43	0.12	8.2	4966	1
4173 44	0.18 / 0.25	13	4966	1
4173 45	0.37 / 0.55	20.8	4966	1
4173 46	0.75	32.5	4966	1
4173 47	1.5	52	5028	1
4173 48	2.2	78	5028	1
4173 49	3	104	5028	1
4173 50	4	130	5300	1
4173 51	5.5	169	5630	1

415 V breaking capacity Icu (kA) - 50

4173 52	7.5	221	7252	1
4173 53	7.5	286	7252	1
4173 54	11	338	7252	1
4173 55	15	416	11994	1

MPCBs MPX³ accessories

Cat.Nos	Description	MRP* ₹ / Unit	Pack
---------	-------------	---------------------	------

Auxiliary contacts

2 pole

Side mounting

Mounting on the left side of MPCBs
Two auxiliary contacts per MPCB

4174 00	1 NO + 1 NC	954	5
4174 01	2 NO	954	5
4174 02	2 NC	954	5

Front mounting

One auxiliary contact per MPCB

4174 03	1 NO + 1 NC	984	5
4174 04	2 NO	984	5
4174 05	2 NC	984	5

Bold Cat.Nos are products normally available with Legrand (India) Stockists.
Cat.Nos that are not bold - delivery within 4 - 8 weeks from the date of order.
Bold packing quantity is our mandatory packing. Orders to be placed by Legrand (India) Stockist in multiples of the same.



4173 68



4174 00

* MRP - Maximum Retail Price Inclusive of all taxes including GST.

MPCBs MPX³ accessories

Cat.Nos	Description	MRP* ₹ / Unit	Pack
---------	-------------	---------------------	------

Alarm contacts

1 NO + 1 NC

Any trip alarm contact

Operates in case of trip

Mounting on the left side of MPCBs

Set alarm contact first in case of using auxiliary contact together (MPX³ 63H can not accept auxiliary contact and alarm contact together)

4174 06	For MPX ³ 32	1540	1
4174 08	For MPX ³ 63 and 100	1540	1

Magnetic trip alarm contact

Operates in case of instantaneous trip

Mounting on the left side of MPCBs

Set alarm contact first in case of using auxiliary contact together

4174 07	1 NO + 1 NC	1540	1
---------	-------------	------	---

Shunt release

Mounting on the right side of MPCBs

One release per MPCB

4174 10	24 V~ 50 Hz / 28 V~ 60 Hz	2448	1
4174 11	110 V~ 50 Hz / 120 V~ 60 Hz	2448	1
4174 12	220-230 V~ 50 Hz / 240-260 V~ 60 Hz	2448	1
4174 13	380-400 V~ 50 Hz / 440-460 V~ 60 Hz	2448	1

Undervoltage release

Mounting on the right side of MPCBs

One release per MPCB

Without auxiliary contact

4174 20	24 V~ 50 Hz / 28 V~ 60 Hz	2448	1
4174 21	110 V~ 50 Hz / 120 V~ 60 Hz	2448	1
4174 22	220-230 V~ 50 Hz / 240-260 V~ 60 Hz	2448	1



4174 12



4174 22

MPCBs MPX³ accessories

Cat.Nos	Description	MRP* ₹ / Unit	Pack
---------	-------------	---------------------	------

4174 23	380-400 V~ 50 Hz / 440-460 V~ 60 Hz	2448	1
---------	--	------	---

With 2 NO auxiliary contacts

Can not attach to MPX³ 32S

4174 30	24 V~ 50 Hz / 28 V~ 60 Hz	3264	1
4174 31	110 V~ 50 Hz / 120 V~ 60 Hz	3264	1
4174 32	220-230 V~ 50 Hz / 240-260 V~ 60 Hz	3264	1
4174 33	380-400 V~ 50 Hz / 440-460 V~ 60 Hz	3264	1

Dial Cover

Sealable cover to protect the set value from the operation that is not intended

Without auxiliary contact

4174 79	For all types of MPX ³	108	50
---------	-----------------------------------	-----	----

Direct adaptor and mounting unit

For mounting CTX³ contactors under MPX³ MPCBs

Direct adaptators

Used to connect MPX³ directly with the contactor

4174 40	For MPX ³ 32S with CTX ³ mini AC	572	2
4174 41	For MPX ³ 32S with CTX ³ mini DC	572	2
4174 42	For MPX ³ 32H/32MA with CTX ³ mini AC	572	2
4174 43	For MPX ³ 32H/32MA with CTX ³ mini DC	572	2
4174 48	For MPX ³ 32S with CTX ³ 22 AC	684	2

MPCBs MPX³ accessories

Cat.Nos	Description	MRP* ₹ / Unit	Pack
4174 49	For MPX ³ 32S with CTX ³ 22 DC	684	2
4174 50	For MPX ³ 32H/32MA with CTX ³ 22 AC	684	2

Direct adaptators

Used to connect MPX³ directly with the contactor

4174 51	For MPX ³ 32H/32MA with CTX ³ 22 DC	684	2
4174 52	For MPX ³ 32S with CTX ³ 40 AC	832	2
4174 53	For MPX ³ 32S with CTX ³ 40 DC	832	2
4174 54	For MPX ³ 32H/32MA with CTX ³ 40 AC	832	2
4174 55	For MPX ³ 32H/32MA with CTX ³ 40 DC	832	2
4174 56	For MPX ³ 63H with CTX ³ 65 AC with cage type terminals	1000	2
4174 57	For MPX ³ 63H with CTX ³ 65 DC with cage type terminals	1000	2
4174 58	For MPX ³ 100H with CTX ³ 100 AC with cage type terminals	1000	1
4174 59	For MPX ³ 100H with CTX ³ 100 DC with cage type terminals	1000	1

Mounting unit

This device is used for joining together MPX³ MPCBs and CTX³ contactors

4174 60	For MPX ³ 32S/32H/32MA	772	2
---------	-----------------------------------	-----	---

MPCBs MPX³ accessories

Cat.Nos	Description	MRP* ₹ / Unit	Pack
4174 61	For MPX ³ 63H	1424	1
4174 62	For MPX ³ 100H	1716	1

Rotary handle

Mounting on panel's door to control the MPX³

4174 63	For MPX ³ 32H and 32 MA	2022	1
4174 64	For MPX ³ 63H	2022	1
4174 65	For MPX ³ 100H	2562	1

Phase busbar

For parallel connection of MPX³

For MPX³ 32S, 32H and 32MA

Rated current 63 A

4174 71	2 devices	800	5
4174 73	3 devices	2002	5
4174 75	4 devices	2002	5
4174 76	5 devices	2002	5
4174 77	Feeder for phase busbar 32 A	558	5

For MPX³ 63H

Rated current 108 A

4174 72	2 devices	1424	5
4174 74	3 devices	2144	5

Enclosures for MPX³ 32H and 32MA

IP 65 enclosure to use in dusty areas as well as in presence of corrosive gas or liquid

4174 80	Yellow/red with rotary handle	1648	5
4174 81	With black rotary handle	2144	5



4174 61



4174 63



4174 73

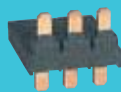

4174 56



4174 81

Alpx³

SELF-HEALING
ENERGY EFFICIENT
CAPACITORS



KEY FEATURES

ROBUST PERFORMANCE EVEN STANDARD DUTY CAN BE USED IN 10% THDI

- Better heat dissipation
- Ease of installation
- Premium quality
- Compact design
- Low energy loss
- Built-in terminal connectors
- Self-healing technology for longer life

APPLICATION BENEFITS



REDUCE
ELECTRICITY
BILLS



INCREASE
SYSTEM
CAPACITY



IMPROVE
VOLTAGE



REDUCE
OVERALL SYSTEM
LOSSES



Scan to know more about
the product.

Alpx³

Resin filled capacitors

Cat.Nos	Description	MRP* ₹ / Unit	Pack
---------	-------------	------------------	------

Alpx³

Confirms to IS13340-1&2 , IEC60831-1&2
ISI Mark
Compact Design
Self healing metallized polypropylene film
Over pressure device for disconnection
Low energy losses
Resistance to high temperature
Resin filled

Can be used in system with <= 10% THDI

Standard duty can-type 440 V

5150 00	1 kVAr Resin std duty 440 V	312	1
5150 01	2 kVAr Resin std duty 440 V	656	1
5150 02	3 kVAr Resin std duty 440 V	940	1
5150 03	4 kVAr Resin std duty 440 V	1312	1
5150 04	5 kVAr Resin std duty 440 V	1540	1
5150 05	7.5 kVAr Resin std duty 440 V	2264	1
5150 06	10 kVAr Resin std duty 440 V	3024	1
5150 07	12.5 kVAr Resin std duty 440	3778	1
5150 08	15 kVAr Resin std duty 440 V	4532	1
5150 09	20 kVAr Resin std duty 440 V	5932	1
5150 10	25 kVAr Resin std duty 440 V	7488	1
5150 11	30 kVAr Resin std duty 440 V	9020	1

Standard duty can-type 480 V

5150 24	4.2 kVAr Resin 480 V	2318	1
5150 25	6.9 kVAr Resin 480 V	3734	1
5150 26	8.7 kVAr Resin 480 V	4732	1
5150 27	10.4 kVAr Resin 480 V	5688	1
5150 28	14 kVAr Resin 480 V	7576	1
5150 29	17.4 kVAr Resin 480 V	8966	1
5150 30	20.8 kVAr Resin 480 V	10660	1

Standard duty can-type 525 V

5150 31	5 kVAr Resin 525 V	2754	1
5150 32	8.3 kVAr Resin 525 V	4726	1
5150 33	10.4 kVAr Resin 525 V	5694	1
5150 34	12.5 kVAr Resin 525 V	6996	1
5150 35	16.7 kVAr Resin 525 V	8832	1
5150 36	20.8 kVAr Resin 525 V	11298	1
5150 37	25 kVAr Resin 525 V	13222	1

* MRP - Maximum Retail Price Inclusive of all taxes including GST.
Red Cat.Nos - new products

Alpx³

Resin filled capacitors

Cat.Nos	Description	MRP* ₹ / Unit	Pack
---------	-------------	------------------	------

Standard duty box-type 440 V

5150 40	1 kVAr Std box Capacitor 440 V	424	1
5150 41	2 kVAr Std box Capacitor 440 V	844	1
5150 42	3 kVAr Std box Capacitor 440 V	1268	1
5150 43	4 kVAr Std box Capacitor 440 V	1694	1
5150 44	5 kVAr Std box Capacitor 440 V	2084	1
5150 45	7.5 kVAr Std box Capacitor 440 V	3072	1
5150 46	8.33 kVAr Std box Capacitor 440 V	3460	1
5150 47	10 kVAr Std box Capacitor 440 V	4092	1
5150 48	12.5 kVAr Std box Capacitor 440 V	5118	1
5150 49	15 kVAr Std box Capacitor 440 V	6142	1
5150 50	20 kVAr Std box Capacitor 440 V	8034	1
5150 51	25 kVAr Std box Capacitor 440 V	10042	1
5150 52	50 kVAr Std box Capacitor 440 V	20850	1

Can be used in system with <= 15% THDI

Heavy duty can-type 440 V

5150 12	1 kVAr Resin heavy duty 440 V	598	1
5150 13	2 kVAr Resin heavy duty 440 V	1250	1
5150 14	3 kVAr Resin heavy duty 440 V	1792	1
5150 15	4 kVAr Resin heavy duty 440 V	2486	1
5150 16	5 kVAr Resin heavy duty 440 V	2686	1
5150 17	7.5 kVAr Resin heavy duty 440	4030	1
5150 18	10 kVAr Resin heavy duty 440	5274	1
5150 19	12.5 kVAr Resin heavy duty 44	6596	1
5150 20	15 kVAr Resin heavy duty 440	7916	1
5150 21	20 kVAr Resin heavy duty 440	10160	1
5150 22	25 kVAr Resin heavy duty 440	12704	1
5150 23	30 kVAr Resin heavy duty 440	15310	1

Heavy duty box-type 440 V

5150 53	5 kVAr HD box 440 V	3292	1
5150 54	7.5 kVAr HD box 440 V	4806	1
5150 55	8.33 kVAr HD box 440 V	5322	1
5150 56	10 kVAr HD box 440 V	6404	1
5150 57	12.5 kVAr HD box 440 V	8010	1
5150 58	15 kVAr HD box 440 V	9612	1
5150 59	20 kVAr HD box 440 V	12196	1
5150 60	25 kVAr HD box 440 V	15250	1
5150 61	50 kVAr HD box 440 V	30494	1

Bold Cat.Nos are products normally available with Legrand (India) Stockists.
Cat.Nos that are not bold - delivery within 4 - 8 weeks from the date of order.
Bold packing quantity is our mandatory packing. Orders to be placed by Legrand (India) Stockist in multiples of the same.



5150 04



5150 06



5150 47



5150 23

Reactors

Cat.Nos	Description	MRP* ₹ / Unit	Pack
Reactors 7 % duty			
4151 48	Reactor 10 kVAr	17106	1
4151 49	Reactor 12.5 kVAr	22398	1
4151 50	Reactor 25 kVAr	28516	1
4151 51	Reactor 50 kVAr	46382	1
4151 52	Reactor 100 kVAr	92898	1
Reactors 14 % duty			
4151 53	Reactor 12.5 kVAr	30226	1
4151 54	Reactor 25 kVAr	50378	1
4151 55	Reactor 50 kVAr	66606	1
Power factor controller Eco			
4151 95	4 step controller	20136	1
4151 96	6 step controller	18258	1
4151 97	8 step controller	20482	1
4151 98	12 step controller	24346	1



4151 50

* MRP - Maximum Retail Price Inclusive of all taxes including GST.
Red Cat.Nos - new products

Warranty
<ul style="list-style-type: none"> The Company, at its discretion, will replace products if they have any manufacturing defect within 1 years for capacitor, Reactor & APFC controller. The above guarantee is applicable when the products are selected taken into consideration all the technical characteristics of the product published in our catalogue. The guarantee is only applicable when the products are installed as per the Company's instructions and not tampered in any manner. The guarantee states the Company's entire liability. It does not extend to cover consequential loss or damage or installation costs arising from defective products.

Alpx3 range of capacitor - Selection Chart

DETERMINING THE CAPACITOR BANK TYPE ACCORDING TO THE LEVEL OF HARMONICS

For supplies with a high level of harmonic pollution, Legrand recommends capacitor banks with detuned reactors.

The detuned reactor performs a threefold role:



- Increasing the capacitor impedance in relation to the harmonic currents
- Shifting the parallel resonance frequency (Fr.p) of the source and capacitor to below the main

frequencies of the harmonic currents that are causing interference.

Tuning frequency (Hz)	Blocking factor (P%)	Tuning number (n)
189	7	3.78
135	14	2.7

- Helping to reduce harmonic levels in the supply.

The table opposite can be used to select the capacitor bank type according to the degree of harmonic pollution, by measuring the percentage of THDi and THDu or by estimating the percentage total power of SH/ST non-linear loads.

Measurements		Estimates	Type of capacitor to be used	Reactor to be used
THDU %	THDI %	SH/ST %		
≤ 3	≤ 10	≤ 15	Standard Duty	-
≤ 4	≤ 15	≤ 25	Heavy Duty	-
≤ 6	≤ 30	≤ 35	Standard Duty	7% Reactor *14% Reactor if high level of 3rd order harmonics
≤ 8	≤ 40	≤ 50	Heavy Duty	7% Reactor

SH (kVA) is the weighted total power of the harmonic generators present at the transformer secondary.

ST (kVA) is the power rating of the HV/LV transformer.

THDi = Total Harmonic Distortion (THD) is the ratio of the rms value of the harmonic currents In of the order n to the rms value of the fundamental.

THDu = Voltage Distortion (THDu) is caused mainly by the high level of Current Distortion (THDi) and the level of THDu is dependent on the source impedance.

* for example if -

- Ih5 > 0.2x145
- Ih3 : 3rd order harmonic currents
- Ih5 : 5th order harmonic currents

Note: These statements are based on our knowledge of typical application. We clearly point out that these statements cannot be regarded as binding statements about the suitability of our products for a particular customer application. It is necessary that the customer should check and decide whether the product is suitable for use in a particular application.

SURGE PROTECTIVE DEVICES

SOLUTIONS FOR ALL INSTALLATIONS AND RISK LEVELS



Clear, easily identifiable marking for easier maintenance, design in line with other Legrand modular equipment, well thought features: the new SPDs integrate perfectly in the modular rows of Legrand distribution boards and protects sensitive equipment.

Status indicator and remote monitoring of information

Design and marking

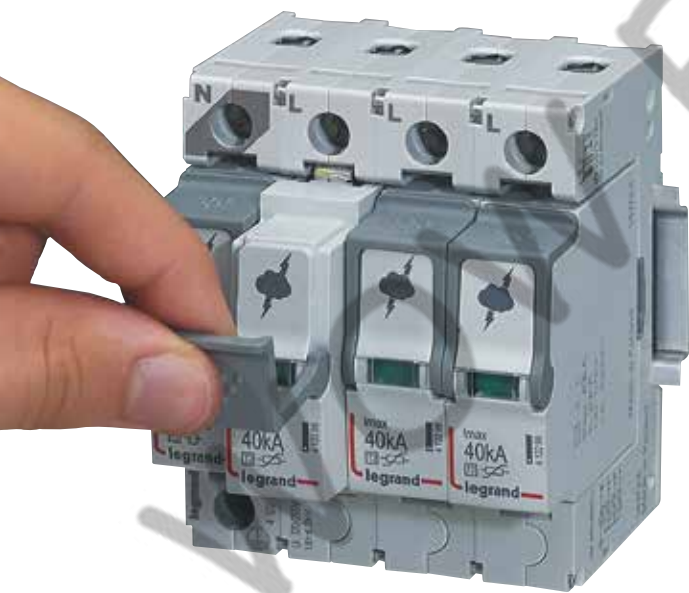

Easier to handle: the plug-in modules are easy to replace thanks to the extraction handles.



- 1 Fault signal contact
- 2 Status indicator



- 3 Dedicated marking for easier identification and maintenance of the SPDs.



Scan to know more about the product.

DX³

PERFECT CONTROL OF YOUR INSTALLATION

The DX³ range has a selection of electrical auxiliaries

for monitoring and controlling circuits remotely

Auxiliary contacts and fault signal contacts, shunt trips, undervoltage releases, motorised controls and automatic reclosers



Power overvoltage protection (POP)

Protects your system from serious damages caused by Overvoltages

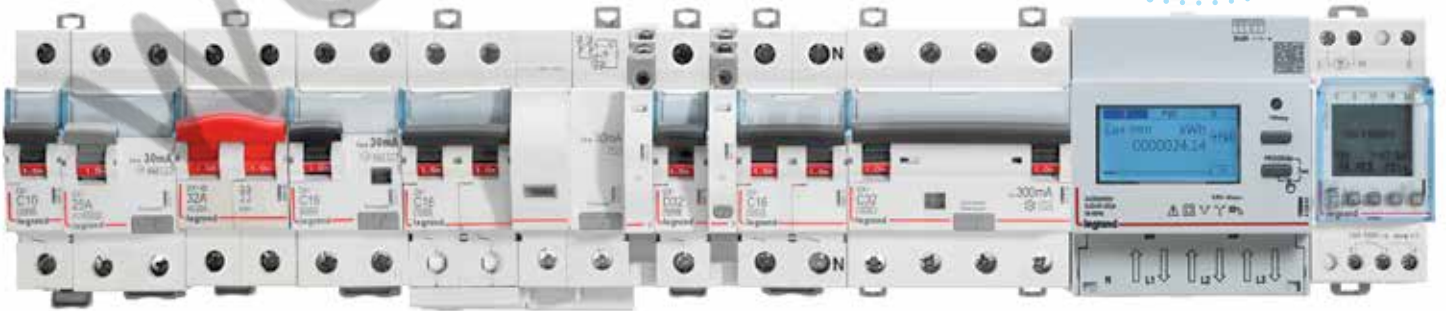

Scan to know more about the product.

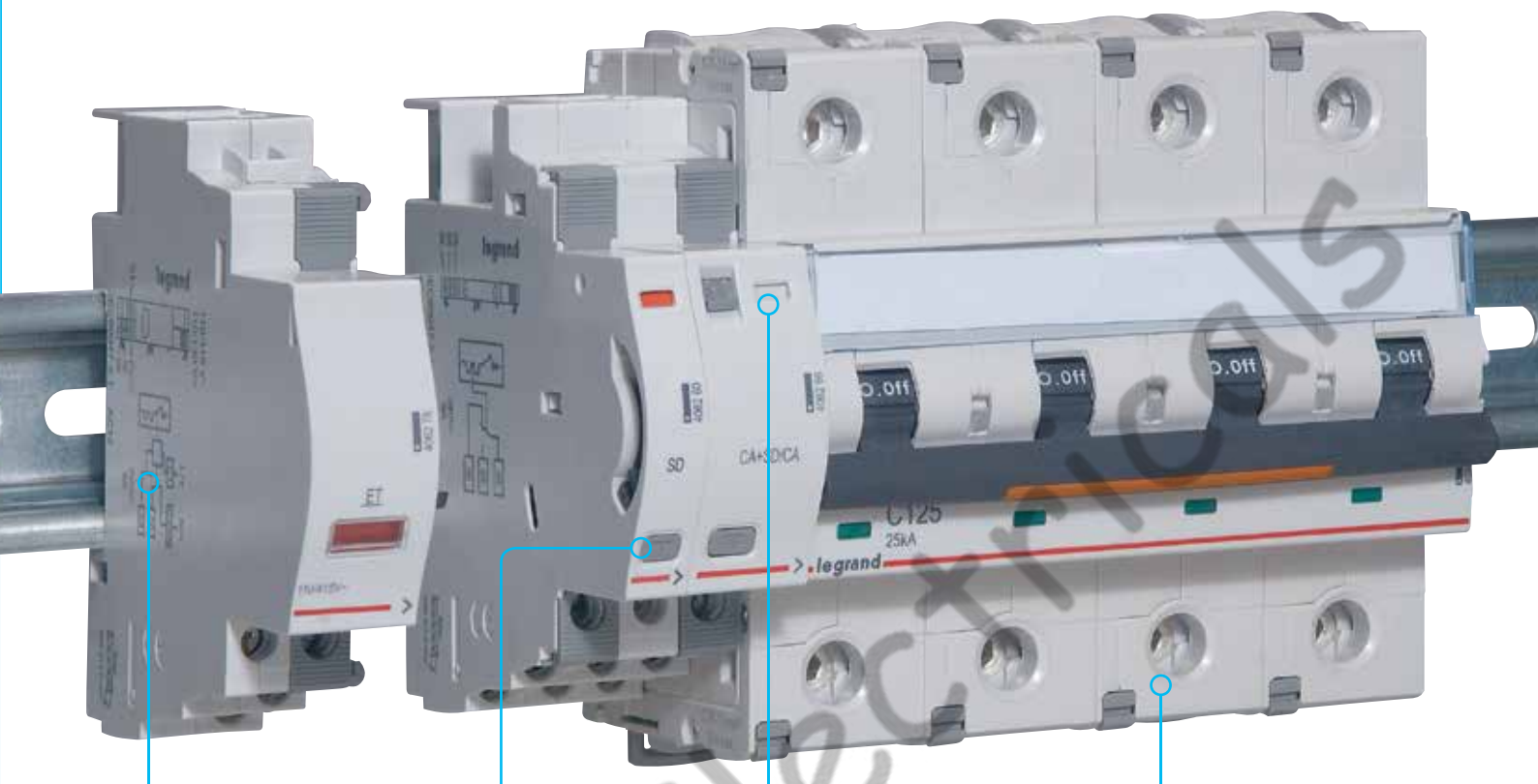

Marking of auxiliaries (characteristics, connection, mounting)

The fault signal contacts have a test button

The colour code of the indicators on the signalling auxiliaries is the same as that of the remote indicators

DX³ circuit breakers take up to 3 auxiliaries including one control auxiliary



OPTIMISED SPACE IN THE DISTRIBUTION BOARD

Legrand motorised controls are the most compact on the market: 1 module wide. They save a great deal of space inside the distribution board.

DX³ motorised controls can be used with 1 module per pole devices (circuit breakers, RCBOs and RCCBs) just as easily as auxiliaries.

DX³ AC MCBs

Cat.Nos	Nominal Rating	Number of 17.5 mm modules	MRP* ₹ / Unit	Pack
---------	----------------	---------------------------	---------------	------

MCBs for AC applications till 63 A

10 kA ISI marked as per IS/IEC 60898-1 2002
 Integrated label holder
 Sliding bottom clamp
 Efficient air channels
 Color coded On/Off indication on dolly
 Biconnect lower terminals
 IP 20 protected terminals
 Sliding shutters
 Compatible with signal and control Auxiliaries

DC-80 V per pole - 1 kA

C Curve

Single pole 240/410 V

4085 80	0.5	1	588	1/10/120
4085 81	1	1	588	1/10/120
4085 83	2	1	588	1/10/120
4085 84	3	1	588	1/10/120
4085 85	4	1	588	1/10/120
4085 87	6	1	367	1/10/120
4085 90	10	1	367	1/10/120
4085 92	16	1	367	1/10/120
4085 93	20	1	367	1/10/120
4085 94	25	1	367	1/10/120
4085 95	32	1	367	1/10/120
4085 96	40	1	832	1/10/120
4085 97	50	1	832	1/10/120
4085 98	63	1	832	1/10/120



4085 90

Single pole + Neutral 240 V

4086 02	0.5	2	1540	1/5/60
4086 03	1	2	1540	1/5/60
4086 05	2	2	1540	1/5/60
4086 06	3	2	1540	1/5/60
4086 07	4	2	1540	1/5/60
4086 09	6	2	1100	1/5/60
4086 12	10	2	1100	1/5/60
4086 14	16	2	1100	1/5/60
4086 15	20	2	1100	1/5/60
4086 16	25	2	1100	1/5/60
4086 17	32	2	1100	1/5/60
4086 18	40	2	1780	1/5/60
4086 19	50	2	1780	1/5/60
4086 20	63	2	1780	1/5/60



4086 14

Double pole 415 V

4086 21	0.5	2	1600	1/40
4086 22	1	2	1600	1/40
4086 24	2	2	1600	1/40
4086 25	3	2	1600	1/40
4086 26	4	2	1600	1/40

* MRP - Maximum Retail Price Inclusive of all taxes including GST.
 ♦ For further details on product contact nearest Legrand Sales Office.

DX³ AC MCBs

Cat.Nos	Nominal Rating	Number of 17.5 mm modules	MRP* ₹ / Unit	Pack
---------	----------------	---------------------------	---------------	------

4086 28	6	2	1178	1/40
4086 31	10	2	1178	1/40
4086 33	16	2	1178	1/40
4086 34	20	2	1178	1/40
4086 35	25	2	1178	1/40
4086 36	32	2	1178	1/40
4086 37	40	2	1854	1/40
4086 38	50	2	1854	1/40
4086 39	63	2	1854	1/40



4086 37

Triple pole 415 V

4086 43	0.5	3	2334	1/32
4086 44	1	3	2334	1/32
4086 46	2	3	2334	1/32
4086 47	3	3	2334	1/32
4086 48	4	3	2334	1/32
4086 50	6	3	1892	1/32
4086 53	10	3	1892	1/32
4086 55	16	3	1892	1/32
4086 56	20	3	1892	1/32
4086 57	25	3	1892	1/32
4086 58	32	3	1892	1/32
4086 59	40	3	2870	1/32
4086 60	50	3	2870	1/32
4086 61	63	3	2870	1/32



4086 55

Triple pole + Neutral 415 V

4086 65	0.5	4	2960	1/32
4086 66	1	4	2960	1/32
4086 68	2	4	2960	1/32
4086 69	3	4	2960	1/32
4086 70	4	4	2960	1/32
4086 72	6	4	2466	1/32
4086 75	10	4	2466	1/32
4086 77	16	4	2466	1/32
4086 78	20	4	2466	1/32
4086 79	25	4	2466	1/32
4086 80	32	4	2466	1/32
4086 81	40	4	3528	1/32
4086 82	50	4	3528	1/32
4086 83	63	4	3528	1/32



4086 77

Four pole 415 V

4086 84	0.5	4	2922	1/32
4086 85	1	4	2922	1/32
4086 87	2	4	2922	1/32
4086 88	3	4	2922	1/32

Bold Cat.Nos are products normally available with Legrand (India) Stockists.
 Cat.Nos that are not bold - delivery within 4 - 8 weeks from the date of order.
 Bold packing quantity is our mandatory packing. Orders to be placed by Legrand (India) Stockist in multiples of the same.

DX³ AC MCBs



4086 94

Cat.Nos	Nominal Rating	Number of 17.5 mm modules	MRP* ₹ / Unit	Pack
4086 89	4	4	2922	1/32
4086 91	6	4	2570	1/32
4086 94	10	4	2570	1/32
4086 96	16	4	2570	1/32
4086 97	20	4	2570	1/32
4086 98	25	4	2570	1/32
4086 99	32	4	2570	1/32
4087 00	40	4	3656	1/32
4087 01	50	4	3656	1/32
4087 02	63	4	3656	1/32

D Curve

Single pole 240/415 V

4087 06	0.5	1	592	1/10/120
4087 07	1	1	592	1/10/120
4087 09	2	1	592	1/10/120
4087 10	3	1	592	1/10/120
4087 11	4	1	592	1/10/120
4087 12	6	1	500	1/10/120
4087 14	10	1	500	1/10/120
4087 16	16	1	500	1/10/120
4087 17	20	1	500	1/10/120
4087 18	25	1	500	1/10/120
4087 19	32	1	500	1/10/120
4087 20	40	1	900	1/10/120
4087 21	50	1	900	1/10/120
4087 22	63	1	900	1/10/120

Single pole + Neutral 240 V

4087 26	0.5	2	1540	1/5/60
4087 27	1	2	1540	1/5/60
4087 29	2	2	1540	1/5/60
4087 30	3	2	1540	1/5/60
4087 31	4	2	1540	1/5/60

Double pole 415 V

4087 32	0.5	2	1598	1/40
4087 33	1	2	1598	1/40
4087 35	2	2	1598	1/40
4087 36	3	2	1598	1/40
4087 37	4	2	1598	1/40
4087 38	6	2	1208	1/40
4087 40	10	2	1208	1/40
4087 42	16	2	1208	1/40
4087 43	20	2	1208	1/40
4087 44	25	2	1208	1/40
4087 45	32	2	1208	1/40
4087 46	40	2	1970	1/40



4087 46

* MRP - Maximum Retail Price Inclusive of all taxes including GST.

♦ For further details on product contact nearest Legrand Sales Office.

D Curve



4087 52

Cat.Nos	Nominal Rating	Number of 17.5 mm modules	MRP* ₹ / Unit	Pack
4087 47	50	2	1970	1/40
4087 48	63	2	1970	1/40

Triple pole 415 V

4087 52	0.5	3	2380	1/32
4087 53	1	3	2380	1/32
4087 55	2	3	2380	1/32
4087 56	3	3	2380	1/32
4087 57	4	3	2380	1/32
4087 58	6	3	1950	1/32
4087 60	10	3	1950	1/32
4087 62	16	3	1950	1/32
4087 63	20	3	1950	1/32
4087 64	25	3	1950	1/32
4087 65	32	3	1950	1/32
4087 66	40	3	3012	1/32
4087 67	50	3	3012	1/32
4087 68	63	3	3012	1/32

Triple pole + Neutral 415 V

4087 72	0.5	4	2902	1/32
4087 73	1	4	2902	1/32
4087 75	2	4	2902	1/32
4087 76	3	4	2902	1/32
4087 77	4	4	2902	1/32

Four pole 415 V

4087 78	0.5	4	2894	1/32
4087 79	1	4	2894	1/32
4087 81	2	4	2894	1/32
4087 82	3	4	2894	1/32
4087 83	4	4	2894	1/32
4087 84	6	4	2552	1/32
4087 86	10	4	2552	1/32
4087 88	16	4	2552	1/32
4087 89	20	4	2552	1/32
4087 90	25	4	2552	1/32
4087 91	32	4	2552	1/32
4087 92	40	4	3856	1/32
4087 93	50	4	3856	1/32
4087 94	63	4	3856	1/32



4087 90

Circuit breakers AC applications 80 - 125 A

10 kA as per IEC 60947-2
Integrated label holder
Sliding insulating shield
Color coded contact indication window
IP 20 protected terminals
50 sq mm terminals

*Single pole 230 V / 400 V

4085 99	80	1.5	3198	1/5/160
---------	----	-----	------	---------

Bold Cat.Nos are products normally available with Legrand (India) Stockists. Cat.Nos that are not bold - delivery within 4 - 8 weeks from the date of order. Bold packing quantity is our mandatory packing. Orders to be placed by Legrand (India) Stockist in multiples of the same.

DX³ MCB

Cat.Nos	Nominal Rating	Number of 17.5 mm modules	MRP* ₹ / Unit	Pack
4086 00	100	1.5	3550	1/5/161
4086 01	125	1.5	3796	1/5/162

4086 00

Double pole 230 V / 400 V[†]

4086 40	80	3	7052	1/5/60
4086 41	100	3	7516	1/5/60
4086 42	125	3	8184	1/5/60

4086 40

Triple pole 400 V[†]

4086 62	80	4.5	11224	1/9
4086 63	100	4.5	11956	1/9
4086 64	125	4.5	13140	1/9

4086 63

Four pole 400 V[†]

4087 03	80	6	14614	1/9
4087 04	100	6	15226	1/9
4087 05	125	6	17058	1/9

4087 05

DX³ DC MCBs

Circuit breakers DC applications upto 63 A

6 kA as per IEC 60947-2
Integrated label holder
Sliding bottom clamp
Improved air channels
Color coded On/Off indication on dolly
Biconnect lower terminals
IP 20 protected terminals
Sliding shutters

Single pole 250 V

4087 98	0.5	1	880	1/10/120
4087 99	1	1	880	1/10/120
4088 01	2	1	880	1/10/120
4088 02	3	1	880	1/10/120
4088 03	4	1	880	1/10/120
4088 04	6	1	736	1/10/120
4088 06	10	1	736	1/10/120
4088 08	16	1	736	1/10/120
4088 09	20	1	736	1/10/120
4088 10	25	1	736	1/10/120
4088 11	32	1	736	1/10/120
4088 12	40	1	972	1/10/120
4088 13	50	1	972	1/10/120
4088 14	63	1	972	1/10/120

4088 12

Double pole 250 V

4088 15	0.5	1	1828	1/5/60
4088 16	1	1	1828	1/5/60
4088 18	2	1	1828	1/5/60
4088 19	3	1	1828	1/5/60
4088 20	4	1	1828	1/5/60
4088 21	6	1	1694	1/5/60

DX³ MCB

Cat.Nos	Nominal Rating	Number of 17.5 mm modules	MRP* ₹ / Unit	Pack
4088 23	10	1	1694	1/5/60
4088 25	16	1	1694	1/5/60
4088 26	20	1	1694	1/5/60
4088 27	25	1	1694	1/5/60
4088 28	32	1	1694	1/5/60
4088 29	40	1	1998	1/5/60
4088 30	50	1	1998	1/5/60
4088 31	63	1	1998	1/5/60

DX³ RDSO DC MCB

Single pole

4088 32	0.5	1	902	1/10/120
4088 33	1	1	902	1/10/120
4088 34	1.5	1	902	1/10/120
4088 35	1.6	1	902	1/10/120
4088 36	2.5	1	902	1/10/120
4088 37	3	1	660	1/10/120
4088 38	4	1	660	1/10/120
4088 39	5	1	802	1/10/120
4088 40	10	1	802	1/10/120
4088 41	15	1	802	1/10/120
4088 42	20	1	802	1/10/120
4088 43	25	1	802	1/10/120
4088 44	30	1	916	1/10/120
4088 45	35	1	916	1/10/120
4088 46	40	1	1018	1/10/120
4088 47	50	1	1018	1/10/120
4088 48	60	1	1018	1/10/120

DX³ isolators

Isolators for AC applications upto 125 A

ISI marked as per IEC 60947-3

Integrated label holder
Ergonomic red color dolly
Sliding bottom clamp
Double break mechanism
Improved air channels
Color coded On/Off indication on dolly
Biconnect lower terminals
IP 20 protected terminals
Compatible with signal and control Auxiliaries
Sliding shutters

Double pole 240 V

4065 00	32	2	626	1/5/60
4065 01	40	2	690	1/5/60
4065 02	63	2	912	1/5/60
4065 04	100	2	1252	1/5/60
4065 05	125	2	1424	1/5/60

4065 00

Triple pole 415 V

4065 09	32	3	1130	1/40
4065 10	40	3	1212	1/40
4065 11	63	3	1442	1/40

4065 10

* MRP - Maximum Retail Price Inclusive of all taxes including GST.
† For further details on product contact nearest Legrand Sales Office.

Bold Cat.Nos are products normally available with Legrand (India) Stockists. Cat.Nos that are not bold - delivery within 4 - 8 weeks from the date of order. Bold packing quantity is our mandatory packing. Orders to be placed by Legrand (India) Stockist in multiples of the same.

Isolators for AC applications upto 125 A

Cat.Nos	Nominal Rating	Number of 17.5 mm modules	MRP* ₹ / Unit	Pack
4065 13	100	3	1592	1/40
4065 14	125	3	1836	1/40

Four pole 415 V

4065 18	32	4	1240	1/32
4065 19	40	4	1538	1/32
4065 20	63	4	1698	1/32
4065 22	100	4	2050	1/32
4065 23	125	4	2260	1/32



4065 20

DX³ RCCBs

RCCBs for AC applications upto 63 A

ISI marked as per IS 12640-1

Integrated label holder

Ergonomic Grey color dolly

Sliding bottom clamp

Compatible with signal and control Auxiliaries

Color coded On/Off indication on dolly

Biconnect lower terminals

IP 20 protected terminals

35 sq mm terminals

Sliding shutters

Type -AC

Sensitive to residual alternating currents

Use : standard applications

Double pole 240 V

30 mA

4118 51	25	2	3640	1/5/60
4118 52	40	2	4226	1/5/60
4118 53	63	2	5196	1/5/60



4118 57

100 mA

4118 56	25	2	4000	1/5/60
4118 57	40	2	4620	1/5/60
4118 58	63	2	5502	1/5/60

300 mA

4118 61	25	2	4070	1/5/60
4118 62	40	2	4708	1/5/60
4118 63	63	2	5522	1/5/60

Four pole 415 V

30 mA

4118 76	25	4	4980	1/32
4118 77	40	4	5104	1/32
4118 78	63	4	5678	1/32



4118 77

100 mA

4118 81	25	4	5250	1/32
4118 82	40	4	5312	1/32
4118 83	63	4	6248	1/32



4118 83

300 mA

4118 86	25	4	5406	1/32
4118 87	40	4	5486	1/32
4118 88	63	4	6268	1/32

RCCBs for AC applications upto 63 A

Cat.Nos	Nominal Rating	Number of 17.5 mm modules	MRP* ₹ / Unit	Pack
---------	----------------	---------------------------	---------------	------

Type -S

Delayed trip for discrimination with other residual current devices.

Use : for discrimination with a downstream device

Double pole 415 V, A-S

300 mA

4118 66	25	2	6992	1/5/60
4118 67	40	2	7340	1/5/60
4118 68	63	2	7516	1/5/60

Four pole 415 V, A-S

300 mA

4118 91	25	4	7834	1/5/60
4118 92	40	4	7934	1/5/60
4118 93	63	4	8290	1/5/60



4118 93

Type Hpi

Enhanced immunity to unwanted tripping in environments with disturbances. eg. diesels, computers, printers, etc.

• Detects faults with DC components eg. thyristors, trio etc.

Double pole 240 V, HPI

30 mA

4118 71	25	2	7644	1/5/60
4118 72	40	2	8026	1/5/60
4118 73	63	2	8258	1/5/60

Four pole 415 V, HPI

30 mA

4118 96	25	4	8658	1/32
4118 97	40	4	8932	1/32
4118 98	63	4	9164	1/32



4118 97

DX³ RCBOs

RCBOs assembled for AC applications upto 63 A

ISI marked as per IS 12640-2

Integrated label holder

Ergonomic design

Color coded On/Off indication on dolly

Compatible with signal and control Auxiliaries

Front face indication for earth leakage fault

IP 20 protected terminals

35 sq mm terminals

Sliding shutters

Type -AC

Sensitive to residual alternating currents

Use : standard applications

Double pole 240 V, AC Type

30 mA

4113 22	6	4	4524	1/32
4113 23	10	4	4524	1/32
4113 24	16	4	4574	1/32
4113 25	25	4	4574	1/32
4113 26	32	4	4774	1/32
4113 27	40	4	5482	1/32
4113 28	63	4	6680	1/32



4113 24

* MRP - Maximum Retail Price Inclusive of all taxes including GST.

Bold Cat.Nos are products normally available with Legrand (India) Stockists. Cat.Nos that are not bold - delivery within 4 - 8 weeks from the date of order. Bold packing quantity is our mandatory packing. Orders to be placed by Legrand (India) Stockist in multiples of the same.

RCBOs assembled for AC applications upto 63 A

Cat.Nos	Nominal Rating	Number of 17.5 mm modules	MRP* ₹ / Unit	Pack
---------	----------------	---------------------------	---------------	------

100 mA

4113 29	6	4	5636	1/32
4113 30	10	4	5636	1/32
4113 31	16	4	5452	1/32
4113 32	25	4	5452	1/32
4113 33	32	4	5452	1/32
4113 34	40	4	6224	1/32
4113 35	63	4	7182	1/32

300 mA

4113 36	16	4	5664	1/32
4113 37	25	4	5664	1/32
4113 38	32	4	5664	1/32
4113 39	40	4	6386	1/32
4113 40	63	4	7194	1/32

Four pole 415 V, AC Type 30 mA

4113 65	16	7	6110	1/16
4113 66	25	7	6110	1/16
4113 67	32	7	6302	1/16
4113 68	40	7	6414	1/16
4113 69	63	7	7356	1/16

Four pole 415 V, AC Type 100 mA

4113 70	16	7	6886	1/16
4113 71	25	7	6886	1/16
4113 72	32	7	6952	1/16
4113 73	40	7	7082	1/16
4113 74	63	7	7796	1/16

Four pole 415 V, AC Type 300 mA

4113 75	16	7	7102	1/16
4113 76	25	7	7102	1/16
4113 77	32	7	7224	1/16
4113 78	40	7	7368	1/16
4113 79	63	7	7932	1/16



4113 79

RCBOs compact for AC applications upto 32 A, 6 kA

Conforms to IEC 60947
Integrated label holder
Ergonomic design
Color coded On/Off indication on dolly
Front face indication for earth leakage fault
IP 20 protected terminals
35 sq mm terminals
Sliding shutters

* MRP - Maximum Retail Price Inclusive of all taxes including GST.

RCBOs compact for AC applications

Cat.Nos	Description	Number of 17.5 mm modules	MRP* ₹ / Unit	Pack
---------	-------------	---------------------------	---------------	------

Type -AC

Sensitive to residual alternating currents

Use : standard applications

Double pole 240 V, AC Type

30 mA

4113 90	6	2	5378	1/32
4113 91	10	2	5378	1/32
4113 92	16	2	5378	1/32
4113 93	20	2	5378	1/32
4113 94	25	2	5378	1/32
4113 95	32	2	5644	1/32



4113 94

300 mA

4113 97	6	2	5540	1/32
4113 98	10	2	5638	1/32
4113 99	16	2	5638	1/32
4114 00	20	2	5638	1/32
4114 01	25	2	5638	1/32
4114 02	32	2	5918	1/32

Four pole 415 V, AC Type 30 mA

4114 18	10	4	7314	1/16
4114 19	16	4	7314	1/16
4114 20	20	4	7314	1/16
4114 21	25	4	7314	1/16

Four pole 415 V, AC Type 300 mA

4114 23	10	4	8402	1/16
4114 24	16	4	8402	1/16
4114 25	20	4	8402	1/16
4114 26	25	4	8402	1/16

Type Hpi

Enhanced immunity to unwanted tripping in environments with disturbances. eg. diesels, computers, printers, etc.

• Detects faults with DC components eg. thyristors, trio etc.

Double pole 240 V, HPI Type

30 mA

4114 15	25	2	10202	1/32
4114 16	32	2	10784	1/32
4114 17	40	2	13646	1/32

Type A

Sensitive to residual alternating currents and residual currents with a DC component.

Use : special applications

- if it is possible that the fault currents are not purely sinusoidal (rectifier bridge, etc.)

Four pole 415 V, A Type

30 mA

4114 28	10	4	8248	1/16
4114 29	16	4	8248	1/16
4114 30	20	4	8248	1/16
4114 31	25	4	8248	1/16

Bold Cat.Nos are products normally available with Legrand (India) Stockists. Cat.Nos that are not bold - delivery within 4 - 8 weeks from the date of order. Bold packing quantity is our mandatory packing. Orders to be placed by Legrand (India) Stockist in multiples of the same.

RCBOs compact for AC applications

Cat.Nos	Nominal Rating	Number of 17.5 mm modules	MRP* ₹ / Unit	Pack
---------	----------------	---------------------------	---------------	------

Four pole 415 V, A Type 300 mA

4114 33	10	4	9298	1/16
4114 34	16	4	9298	1/16
4114 35	20	4	9298	1/16
4114 36	25	4	9298	1/16

DX³ RCD add on module

For 125 A

Conform to IEC 61009-1

AC type : detect AC components faults

Hpi type :detect faults with AC and DC components, increased

Immunity to false tripping

For mounting on the right-hand side of 1.5 module per pole DX³ MCBs

Easy & fast association mechanism

Terminal cover for locking

70 sq mm terminals

Double pole 240 V, AC Type 30 mA

4105 68	125 A	4	16750	1
---------	-------	---	-------	---

100 mA

4105 69	125 A	4	18886	1
---------	-------	---	-------	---

300 mA

4105 71	125 A	4	18886	1
---------	-------	---	-------	---

Four pole 415 V, AC Type 30 mA

4106 25	125 A	4	25882	1
---------	-------	---	-------	---

100 mA

4106 26	125 A	4	28922	1
---------	-------	---	-------	---

300 mA

4106 29	125 A	4	28922	1
---------	-------	---	-------	---

Double pole 240 V, HPI type 30 mA

4105 78	125 A	6	20872	1
---------	-------	---	-------	---

100 mA

4105 79	125 A	6	23330	1
---------	-------	---	-------	---

300 mA

4105 82	125 A	6	23330	1
---------	-------	---	-------	---

Four pole 415 V, HPI type 30 mA

4106 38	125 A	6	35778	1
---------	-------	---	-------	---

100 mA

4106 39	125 A	6	37868	1
---------	-------	---	-------	---

300 mA

4106 42	125 A	6	37868	1
---------	-------	---	-------	---

* MRP - Maximum Retail Price Inclusive of all taxes including GST.



4105 68



4105 78



4062 50



4062 52



4062 78



4062 82

DX³ auxiliaries

Cat.Nos	Description	Number of 17.5 mm modules	MRP* ₹ / Unit	Pack
---------	-------------	---------------------------	---------------	------

Auxiliaries common for MCBs, Isolators, RCCBs & RCBOs

Easy & fast fixation on site

On site clip on mounting

Clip on fitting on left side

Signalling auxiliaries

4062 50	Auxiliary changeover switch 6 A	0.5	1186	1
4062 52	Fault signalling changeover switch 6 A	0.5	1384	1
4062 64	Changeover + fault signalling switch	1	2190	1

Control auxiliaries

4062 76	Shunt release 12 /48 V AC/ DC	1	3048	1
4062 78	Shunt release 110/415 V V AC	1	3048	1
4062 80	Undervoltage release 24/48 V AC/DC	1	2596	1
4062 82	Undervoltage release 230 V AC	1	2596	1

Control auxiliaries

4062 86	Pop over voltage release	1	3308	1
4062 90	Motor control 24/48 V AC/ DC	1	11926	1
4062 91	Motor control 110/415 V AC	1	11926	1
4062 93	Motor control 24/48 V AC/ DC	2	22452	1
4062 95	Motor control 110/415 V AC	2	21206	1
4062 88	Automatic resetter	2	15836	1
4062 89	Automatic resetter with autotest	2	19820	1

Bold Cat.Nos are products normally available with Legrand (India) Stockists. Cat.Nos that are not bold - delivery within 4 - 8 weeks from the date of order. Bold packing quantity is our mandatory packing. Orders to be placed by Legrand (India) Stockist in multiples of the same.

DX³ auxiliaries

Cat.Nos	Description	Number of 17.5 mm modules	MRP* ₹ / Unit	Pack
---------	-------------	---------------------------	---------------	------

Rotary handle

4063 19	Black rotary handle	-	2476	10
4063 20	Yellow/red rotary handle	-	2680	10

Support for padlock

4063 03	Support for padlock till 63 A	-	574	10
---------	-------------------------------	---	-----	----

Sealable screw cover

4063 04	Devices upto 63 A	-	568	10
4063 06	For 80-125 A devices	-	990	10

1/2 module spacing unit

4063 07	1/2 module spacing unit	0.5	212	10
---------	-------------------------	-----	-----	----

5 mm padlock

4063 13	5 mm Padlock	0.5	486	10
---------	--------------	-----	-----	----

Manual changover switch

Compact design
Manual switching operation
Easy to assemble
Ergonomic design

For 1 mod/pole devices

4063 14	Manual change-over switch for DP	1	2812	5
4063 15	Manual change-over switch for TP	1	3248	5
4063 16	Manual change-over switch for FP	1	3608	5

DX³ RCD add on module

with measurement & metering

Cat.Nos	Nominal Rating	Number of 17.5 mm modules	MRP* ₹ / Unit	Pack
---------	----------------	---------------------------	---------------	------

Conform to IEC 61009-1
Hpi type: detect faults with AC and DC components, increased
Immunity to false tripping
Inbuilt measurement/metering option
Measurement - V, A, F, PF, kWh, KVA, KVAR, THD
Metering - V, A, F, kWh
RS 485 port for remote reading
Di-electric test button inbuilt
Ergonomic test button
Scroll button for easy readings
RLCD display on front facia
For mounting on the right-hand side of 1.5 module per pole DX3 MCBs

■ Price available on request.

* MRP - Maximum Retail Price Inclusive of all taxes including GST.

¹ 1P+N and 3P+N: L-N and N-PE protection modes (common and differential modes), the N pole being protected by encapsulated spark gaps. Also called sometimes 1+1 and 3+1

² Replaced mid 2015 by Cat.No 4122 80

DX³ RCD add on module

Cat.Nos	Nominal Rating	Number of 17.5 mm modules	MRP* ₹ / Unit	Pack
---------	----------------	---------------------------	---------------	------

Easy & fast association mechanism
70 sq mm terminals

Adjustable metering, four pole 415 V

4106 57	63 A	7	18312	1
4106 58	125 A	7	32856	1

Adjustable measurement

4106 59	125 A	7	35796	1
---------	-------	---	-------	---

DX³ time switches

Cat.Nos	Description	No. of Modules	MRP* ₹ / Unit	Pack
---------	-------------	----------------	---------------	------

For switching an electric circuit (lighting, heating) ON or OFF at selected times during a pre-programmed time period.

Alpharex3 Digital Time switches

Weekly time switch

Time-saving programming by selection of daily blocks, daily blocks individually adjustable or selection from preset blocks Mo-Fr and Mo-Su

Permanent ON or OFF

Circuit anticipation

Power reserve 3 years for date, time and switching program

Accuracy +/- 1 sec./Day

0037 10	Power supply 230 V~ 50/60Hz 1 NO contact 250 V/50 Hz 16 A - cos ϕ = 1 28 programmes Shortest switching-time 1 min	1	5974	1
---------	--	---	------	---

Multiple functions - daily or weekly time switch programme - 5 years clock working reserve

Programme settings: on daily or weekly basis

15 languages

A programme consists of a on and off time and their assignment to certain days

Option to suspend the programme for a specific period to set-up with start and date

Minimum programme setting: 1 s.

High precision clock: \pm 0.1 sec per day

Particularly suited to irregular cycles:

- security installations (access point, alarms, etc.),

- industrial installations (pump stations, etc.)

Programmed directly on keypad, or using program transfer key Cat.No 4 128 72

Additional functions including random (irregular cycles), hour counters

4126 31	1 output 16 A - 250 V~ 50/60 Hz 56 programmes 1 Channel	2	6774	1
4126 41	2 output 16 A - 250 V~ 50/60Hz 2x28 programmes 2 Channel	2	9536	1



4106 57



4126 41

Bold Cat.Nos are products normally available with Legrand (India) Stockists. Cat.Nos that are not bold - delivery within 4 - 8 weeks from the date of order. Bold packing quantity is our mandatory packing. Orders to be placed by Legrand (India) Stockist in multiples of the same.

DX³ time switches

Cat.Nos	Description	No. of Modules	MRP* ₹ / Unit	Pack
---------	-------------	----------------	------------------	------

Digital time switch with Astronomical Function

- For switching on/off lights and other electric devices according to the rising/setting of the sun
- With combination function for creating switching programs in which the devices are switched according to astronomical time and/or fixed preset times
- Daily astronomical calculation of the sunrise/sunset times based on the entered location or location coordinates



4126 54



4126 57

4126 54	1 output 16 A - 250 V~ 50/60 Hz Astronomical function 56 Programmes 1 Channel	2	12102	1
4126 57	2 output 16 A - 250 V~ 50/60 Hz Astronomical function 2x28 programmes 2 Channel	2	13810	1

Alpharex³ yearly time switch

- Yearly and weekly time switch with additional astronomical function for all channels
- 84 switching programs per channel, comprising:
 - 28 weekly programs
 - 28 yearly programs
 - 28 special programs (priority program)

4126 30	2 outputs - 230 V~ 50/60 Hz Astronomical function 2 x 3 x 28 = 168 programmes	2	22444	1
---------	---	---	-------	---

Cat.Nos	Description	MRP* ₹ / Unit	Pack
---------	-------------	------------------	------

Programming accessories

4128 72	Programming transfer key Can be used to store programme settings made: Directly on a multifunction and multi-programme time switch Cat.Nos 4 126 30/31/32/33/41/54/57 (loading on device) -with the programming software installed on a PC running Windows (loading on data loader)	2522	1
4128 73	Programming software Kit Can be used to create, save and transfer program settings for multi-function and multi-program time switches. Data is transferred to the program transfer key using the data loader connected to the USB port of the PC. 4128 73 Kit comprising software on CD-ROM, data loader and transfer key Windows XP, Windows 7, Windows 8 compatible"	5378	1

* MRP - Maximum Retail Price Inclusive of all taxes including GST.

¹ 1P+N and 3P+N: L-N and N-PE protection modes (common and differential modes), the N pole being protected by encapsulated spark gaps. Also called sometimes 1+1 and 3+1

DX³ time switches

Cat.Nos	Description	MRP* ₹ / Unit	Pack
---------	-------------	------------------	------

Twilight switches

- Light sensitive switches
- Can be used to switch a lighting circuit "ON" and "OFF" based on light conditions (nightfall, daybreak)
- Supplied with IP 65 weatherproof photoelectric cell
- Adjustable from 1 to 100 000 lux

4126 23	Luxo Switch / Light sensitive switch with Lux Sensor - Output 16 A 250 V~	8572	1
---------	---	------	---

MicroRex analog time switches

Programmed via captive segment
Power supply: 230 V~ 50/60 Hz
3-position override switch "ON-AUTO-OFF" on front panel
Manual changeover to summer/winter time
1 outlet 16 A - 250 V~ - $\mu \cos = 1$

Analogue Time Switch Daily programme

1 segment = 15 minutes
Accuracy: ± 5 minutes
1 outlet 16 A - 250 V~ - $\mu \cos = 1$

4127 80	Vertical Dial N/O Contact - without working Reserve -Minimum switching time: 15 minutes	1	3500	1
4127 90	Vertical Dial N/O Contact - with 100 h working Reserve -Minimum switching time: 15 minutes	1	4122	1



4128 12

4128 12	Horizontal Dial Changeover Switch - without working Reserve -Minimum switching time: 15 minutes	3	5280	1
4128 13	Horizontal Dial Changeover Switch - with 100 h working Reserve -Minimum switching time: 15 minutes	3	6540	1

Analogue Time Switch Weekly programme

1 segment = 2 hours
Accuracy: ± 30 minutes
1 outlet 16 A - 250 V~ - $\mu \cos = 1$

4127 94	Vertical Dial N/O Contact - with 100 h working Reserve -Minimum switching time: 2 hours	1	4562	1
4127 95	Horizontal Dial Changeover Switch - with 100 h working Reserve -Minimum switching time: 4 hours	3	6608	1

DX³ contactors

Power contactors / Modular Contactors CX³

Conform to IEC/EN 61095

Space for power supply busbar on top (up to 25 A)

Bold Cat.Nos are products normally available with Legrand (India) Stockists. Cat.Nos that are not bold - delivery within 4 - 8 weeks from the date of order. Bold packing quantity is our mandatory packing. Orders to be placed by Legrand (India) Stockist in multiples of the same.

Power contactors / Modular Contactors CX³

Cat.Nos	Description	MRP* ₹ / Unit	Pack
---------	-------------	------------------	------

Power contactors with 230 V~ coil and handle
Manual override for test and repair function, carried out via the handle
Permanent "ON" or "OFF" without automatic closing of the contactor

4125 44	25 A 2 NO contactor	2502	1
4125 45	40 A 2 NO contactor	4274	1
4125 47	63 A 2 NO contactor	4972	1
4125 48	63 A 2 NC contactor	4972	1
4125 49	40 A 3 NO contactor	7146	1
4125 50	63 A 3 NO contactor	8080	1
4125 51	25 A 4 NO contactor	2952	1
4125 53	40 A 4 NO contactor	7542	1
4125 56	63 A 4 NO contactor	8930	1
4125 57	63 A 4 NC contactor	9014	1

Signalling auxiliaries for contactors

Auxiliary changeover switch

4124 29	For 1 module contactors 16 A to 25 A	3668	1
4124 30	For 2 module contactors 25 A	3680	1
4124 31	For 40 and 63 A contactors	4830	1

DX³ for photovoltaic applications

Cat.Nos	Description	MRP* ₹ / Unit	Pack
---------	-------------	------------------	------

DC MCBs

Breaking capacity 4.5 kA according to EN 60947-2

800 V= circuit breakers

4144 24	6 A	8344	1
4144 25	8 A	8344	1
4144 26	10 A	8344	1
4144 27	13 A	8344	1
4144 28	16 A	8344	1
4144 29	20 A	8344	1

1000 V= circuit breakers

4144 46	10 A	22000	1
4144 47	13 A	22000	1
4144 48	16 A	22000	1
4144 49	20 A	22000	1
4144 50	25 A	22000	1
4144 51	32 A	22000	1

Type 2 voltage surge protectors

DC side protection of photovoltaic installations connected to the low voltage network (without energy storage system)

Conforming to UTE guide C 61-740-51 Protection in common mode and residual current mode (Y mode) 1
Consisting of plug-in modules with LED indicator Red: modules need to be replaced

Voltage surge protectors

* MRP - Maximum Retail Price Inclusive of all taxes including GST.

¹ 1P+N and 3P+N: L-N and N-PE protection modes (common and differential modes), the N pole being protected by encapsulated spark gaps. Also called sometimes 1+1 and 3+1

² Replaced mid 2015 by Cat.No 4122 80

DX³ for photovoltaic applications Type 2 voltage surge protectors

Cat.Nos	Description	MRP* ₹ / Unit	Pack
---------	-------------	------------------	------

4141 55	600 V= 25KA I _{max}	■	1
4141 56	1000 V 40KA I _{max}	■	1

Plug-in replacement module

4141 85	+/- cassette for voltage surge protector 4141 55	■	1
4141 86	T cassette for voltage surge protector 4141 56	■	1

DC rotary handle isolating switches

Category of use DC 21B according to EN 60947-3

Double break contacts

600 V= isolating switches

4142 61	16 A	10368	1
4142 62	25 A	10368	1
4142 63	32 A	10783	1

1000 V= isolating switches

4142 81	16 A	17774	1
4142 82	25 A	17734	1
4142 83	32 A	18430	1

Accessories

4063 05	Pole separation divider	156	1
4063 07	Spacing unit 0.5 unit	212	10

Class I (T1) low voltage SPDs

Cat.Nos	Number of poles	Neutral position	I _{total} (10/350)	Remote lightning monitoring contact (RFS)	Number of modules	MRP* ₹ / Unit
---------	-----------------	------------------	-----------------------------	---	-------------------	------------------

SPDs for general protection of main distribution-board

T1+T2 - limp 12,5 kA/pole T2 - 60 kA

4122 70	1P	-	12.5 kA	No	1	9190
4122 76 ¹	1P+N	Right	25 kA	Yes	2	16170
4122 71	2P	-	25 kA	No	2	17748
4122 72	3P	-	37.5 kA	Yes	3	22002
4122 77 ¹	3P+N	Right	50 kA	Yes	4	29482
4122 73	4P	-	50 kA	No	4	26988

T1+T2 - limp 8 kA/pole T2 - 60 kA

4122 50	1P	-	8 kA	No	1	7678
4122 56 ¹	1P+N	Right	16 kA	No	2	13964
4122 51	2P	-	16 kA	No	2	14834
4122 52	3P	-	25 kA	No	3	20900
4122 57 ¹	3P+N	Right	25 kA	No	4	25402
4122 53	4P	-	32 kA	No	4	26922



4122 57

Bold Cat.Nos are products normally available with Legrand (India) Stockists. Cat.Nos that are not bold - delivery within 4 - 8 weeks from the date of order. Bold packing quantity is our mandatory packing. Orders to be placed by Legrand (India) Stockist in multiples of the same.

Class I (T1) low voltage SPDs

Cat.Nos	Number of poles	Neutral position	Total (10/350)	Remote status monitoring (FS contact)	Number of modules	MRP* ₹ / Unit
---------	-----------------	------------------	----------------	---------------------------------------	-------------------	---------------

SPDs for high risk level installations

T1 - limp 50 kA/pole - 440 V~ (IT) - Monobloc

0030 00	1P	-	50 kA	No	2	8948
---------	----	---	-------	----	---	------

T1 - limp 35 kA/pole - 440 V± (IT) - Plug-in

4122 80	1P	-	35 kA	Yes	2	20342
---------	----	---	-------	-----	---	-------

T1 - limp 25 kA/pole

4122 81 ¹	1P+N	Right	50 kA	Yes	4	26430
4122 82	3P	-	75 kA	Yes	6	63186
4122 83 ¹	3P+N	Right	100 kA	Yes	8	72526



4122 83

4123 03



4122 84

Replacement plug-in modules

Cat.Nos	Description	MRP* ₹ / Unit	Pack
---------	-------------	---------------	------

4123 02	For SPDs T1+T2 - 8 kA Cat.Nos 4122 50/ 51/52/53/56/57	7290	1
4123 03	For SPDs T1+T2 - 12.5 kA Cat.Nos 4122 70/ 71/72/73/76/77	6878	1
4122 84	For SPDs T1 - 25 kA Cat.Nos 4122 81/82/83 and 0030 20/22/23/27	19796	1
4122 85	N-PE module for SPDs T1 - 25 kA Cat.Nos 4122 81/83 and 0030 23	26864	1
4122 86	For SPDs T1 - 35 kA Cat.No 4122 80	6640	1

Cabling accessories

4123 10	Ready to use cabling kit consisting of 5 conductors (including the earth conductor) Cross section : 16 mm ² Length : 40 cm For cabling SPDs in industrial enclosures (for EN/IEC 61439 compliance).	1422	1
---------	---	------	---

Class II (T2) low voltage SPDs

Cat.Nos	Number of poles	Neutral position	Remote status monitoring (FS contact)	Number of modules	MRP* ₹ / Unit	Pack
---------	-----------------	------------------	---------------------------------------	-------------------	---------------	------

T2 SPDs

T2 - I_{max} 40 kA/pole

4122 40	1P	-	No	1	5548	1
4122 46 ¹	1P+N	Right	No	2	10564	1
4122 41	2P	-	No	2	10564	1
4122 42	3P	-	Yes	3	15472	1
4122 47 ¹	3P+N	Right	No	4	18830	1
4122 43	4P	-	No	4	18830	1



4122 43

■ Price available on request.

* MRP - Maximum Retail Price Inclusive of all taxes including GST.

¹ 1P+N and 3P+N: L-N and N-PE protection modes (common and differential modes), the N pole being protected by encapsulated spark gaps. Also called sometimes 1+1 and 3+1

² Replaced mid 2015 by Cat.No 4122 80

Class II (T2) low voltage SPDs

Cat.Nos	Number of poles	Neutral position	Remote status monitoring (FS contact)	Number of modules	MRP* ₹ / Unit	Pack
---------	-----------------	------------------	---------------------------------------	-------------------	---------------	------

T2 - I_{max} 40 kA/pole - 440 V~ (IT)

4122 30	1P	-	No	1	7348	1
4122 32	3P	-	Yes	3	22002	1
4122 33	4P	-	Yes	4	26988	1

T2 - I_{max} 20 kA/pole

4122 20	1P	-	No	1	4308	1
4122 26 ¹	1P+N	Right	No	2	8264	1
4122 21	2P	-	No	2	8264	1
4122 27 ¹	3P+N	Right	No	4	15386	1
4122 23	4P	-	No	4	15386	1

Replacement plug-in modules

Cat.Nos	Description	MRP* ₹ / Unit	Pack
---------	-------------	---------------	------

4122 99	For SPDs T2 - 40 kA Cat.Nos 4122 40/ 41/42/43/44/45/ 46/47/66/67	4692	1
4123 00	N-PE module for SPDs T2 - 40 kA Cat.Nos 4122 46/47	9392	1
4123 01	For SPDs T2 - 440 V Cat.Nos 4122 30/32/33	7222	1
4122 97	For SPDs T2 - 20 kA Cat.Nos 4122 20/ 21/23/26/27/62/63	3548	1
4123 98	N-PE module for SPDs T2 - 20 kA Cat.Nos 4122 24/25/26/27	7706	1



4122 99

Class II (T2) low voltage SPDs with integrated protection

Cat.Nos	Number of poles	Neutral position	Integrated protection	Number of modules	MRP* ₹ / Unit	Pack
---------	-----------------	------------------	-----------------------	-------------------	---------------	------

Protection for consumer units

T2 self protected SPDs - I_{max} 12 kA/pole

0039 51 ¹	1P+N	Left	I _{sc} ≤ 6 kA	2	10768	1
0039 53 ¹	3P+N	Left	I _{sc} ≤ 6 kA	6	23490	1



0039 51



0039 53

Protection for secondary distribution boards

T2 self protected SPDs - I_{max} 12 kA/pole

0039 71 ¹	1P+N	Left	I _{sc} ≤ 10 kA	2	10768	1
0039 73 ¹	3P+N	Left	I _{sc} ≤ 10 kA	6	23490	1

Bold Cat.Nos are products normally available with Legrand (India) Stockists. Cat.Nos that are not bold - delivery within 4 - 8 weeks from the date of order. Bold packing quantity is our mandatory packing. Orders to be placed by Legrand (India) Stockist in multiples of the same.

ACCL

AUTOMATIC CHANGEOVER WITH CURRENT LIMITER

Seamless and uninterrupted switchover for smart spaces



→ Intelligent micro-controller based design

→ Automatic source change over between Mains & Generator supply

→ Manual reset for restoring supply in sleep mode

→ Break before make change over system

→ Direct mount on DIN rail channel

→ Buzzer and LED light indication of status-Overload, Mains, Gen

→ Current limitation function prevents over loading of the generator

→ Neutral isolation



Scan to know more about the product.

Class II (T2) low voltage SPDs with integrated protection

Cat.Nos	Description	MRP* ₹ / Unit	Pack
---------	-------------	------------------	------

Replacement plug-in modules

For self protected SPDs

0039 54	Cat.Nos 0039 51/53	7756	1
0039 74	Cat.Nos 0039 71/73	8022	1

SPDs for telephone lines

Cat.Nos	In/Imax	Max. voltage (Uc)	Level of protection (Up)	No. of modules	MRP* ₹ / Unit	Pack
---------	---------	-------------------	--------------------------	----------------	------------------	------

SPDs for telephone and data lines

"Analogue" SPD (STN, non-unbundled ADSL, etc.)

0038 28	5/10 kA	170 V	260 V	1	14724	1
---------	---------	-------	-------	---	-------	---

"Digital" SPD (unbundled ADSL, SDSL, ISDN, etc.)

0038 29	5/10 kA	48 V	100 V	1	14972	1
---------	---------	------	-------	---	-------	---

DX³ changeover switches

Cat.Nos	Description	MRP* ₹ / Unit	Pack
---------	-------------	------------------	------

Changeover Switches

Single pole - two way - 250 V AC

4129 00	32 A	3800	10/100
---------	------	------	--------

Double pole - two way - 400 V AC

4129 01	32 A	3800	5/50
---------	------	------	------

Double pole - two way with centre off - 400 V AC

4129 03	32 A	3978	5/50
---------	------	------	------

Four pole - two way with centre off - 400 V AC

6040 22	40 A	6160	2/20
---------	------	------	------

Automatic changeover with current limiter(ACCL)

Cat.Nos	Description	MRP* ₹ / Unit	Pack
---------	-------------	------------------	------

Automatic changeover with current limiter(ACCL)

Intelligent micro controller based design

Automatic source change over between Mains &

Generator supply

Break before make change over system

Buzzer and Led Indication of status

Current limitation prevents overloading of the generator

405300	SPN 30/3A	2952	1/15
405301	SPN 30/4A	2952	1/15
405302	SPN 30/5A	2952	1/15
405303	SPN 30/6A	2952	1/15
405304	SPN 30/9A	2952	1/15
405305	SPN 30/12A	2952	1/15
405306	SPN 30/15A	2952	1/15
405307	SPN 30/20A	2952	1/15
405308	SPN 30/30A	2952	1/15

DX³ push button

Push button cum switch

Push button cum switch - 1 module - 20 A-250 V AC

Single function

4129 08	Contact 1 NO	3140	10/100
4129 09	Contact 1 NC	3140	10/60
4129 10	Contact 2 NO	3140	10/60



0039 54



0038 28



0038 29



4129 00



6040 22



4129 08

* MRP - Maximum Retail Price Inclusive of all taxes including GST.

1 1P+N and 3P+N: L-N and N-PE protection modes (common and differential modes), the N pole being protected by encapsulated spark gaps. Also called sometimes 1+1 and 3+1

Bold Cat.Nos are products normally available with Legrand (India) Stockists. Cat.Nos that are not bold - delivery within 4 - 8 weeks from the date of order. Bold packing quantity is our mandatory packing. Orders to be placed by Legrand (India) Stockist in multiples of the same.

DX³ push button

Cat.Nos	Description	MRP* ₹ / Unit	Pack
---------	-------------	------------------	------

Dual function

4129 14	Contact - 1 NO + green indicator	3140	10/60
4129 15	Contact - 1 NC + red indicator	3140	10/60



4129 15

DX³ indicators

Single indicators - 1 module - 250 V AC

Possible to replace E10 lamps and diffusers.

E10 - 1.2 Watt, 230 V AC

4129 26	Colour - Green	914	10/100
4129 27	Colour - Red	914	10/100
4129 28	Colour - Orange	914	10/100
4129 29	Colour - Blue	914	10/100
4129 32	White + White + White	1666	10/100
4129 33	Red + Red + Red	1666	10/100
4129 34	Red + Yellow + Green	454	10/100
4129 35	Red + Yellow + Blue	1698	10/100



4129 27

Lexic time switches

Cat.Nos	Description	MRP* ₹ / Unit	Pack
---------	-------------	------------------	------

Multifunction time delay relay

- Supply voltage : 12 to 230 V AC 50/60 Hz and DC
- Output : 8 A - 250 V AC, $\cos\phi = 1$
- Contact NO

0047 44	Multifunction time delay relay	11000	1
---------	-----------------------------------	-------	---



0047 44

Time lag switch

0047 02	Time lag switch long time (1 module)	7459	10/100
---------	---	------	--------

Rex surface mounting time switches

MaxiRex

6499 15	MaxiRex 4QT (daily)	7034	1/30
6499 14A	MaxiRex 4QTB (daily with IP 53 box)	7158	1
6499 39	MaxiRex 5QW (weekly)	7797	1/30
6499 36A	MaxiRex 4QWB (weekly with IP 53 box)	8454	1



Rex surface mounting time switches

Cat.Nos	Description	MRP* ₹ / Unit	Pack
---------	-------------	------------------	------

EconoRex

0499 86	EconoRex MQT (24hrs.)	6998	1/30
---------	-----------------------	------	------

Accessories

0498 32	Clip on support frame for fascia mounting of MaxiRex QTT and QWT	426	1/5
0044 09	DIN rail adaptor for MaxiRex QTT and QWT	278	1
0044 07	DIN rail adaptor for EconoRex BQTAP	278	1
6499 49	Terminal cover for 4/5 nominal time switch	356	1/30
6499 48	IP53 box for MaxiRex 4 and 5	1094	1/10

Current transformers

- Used with ammeters, electricity meters
- Supply a current of 5 A to the secondary which is proportional to the primary current.
- Fix to plate or rail EN 60715

4121 01	50/5 Precision in % - 1 Power in VA - 1.5	2985	1/12
4121 03	100/5 Precision in % - 1 Power in VA - 1.5	4063	1/12

Rex surface mounting time switches

Cat.Nos	Description	MRP* ₹ / Unit	Pack
---------	-------------	------------------	------

4121 06	200/5 Precision in % - 0.5 Power in VA - 4	4063	1/12
4121 24	200/5 Precision in % - 0.5 Power in VA - 5	4098	1/12
4121 25	400/5 Precision in % - 0.5 Power in VA - 8	4246	1/12
4121 36	600/5 Precision in % - 0.5 Power in VA - 12	4306	1/12
4121 38	800/5 Precision in % - 0.5 Power in VA - 8	6310	1/12
4121 39	1000/5 Precision in % - 0.5 Power in VA - 10	6670	1/12
4121 42	1250/5 Precision in % - 0.5 Power in VA - 12	7778	1/12

Ekinox³

Smart Solutions

The Core Brick
of your installation
is now smarter

Intelligent EI

Ekinox³ Smart Distribution Board allows to measure, monitor and control energy from anywhere. Equipped with smart products like EMDX³, CX³ EMS & intelligent accessories. Ekinox³ helps to evaluate electrical distribution in real time seamlessly.



VTPN MCCB + METER B



Scan to know more about
the product.

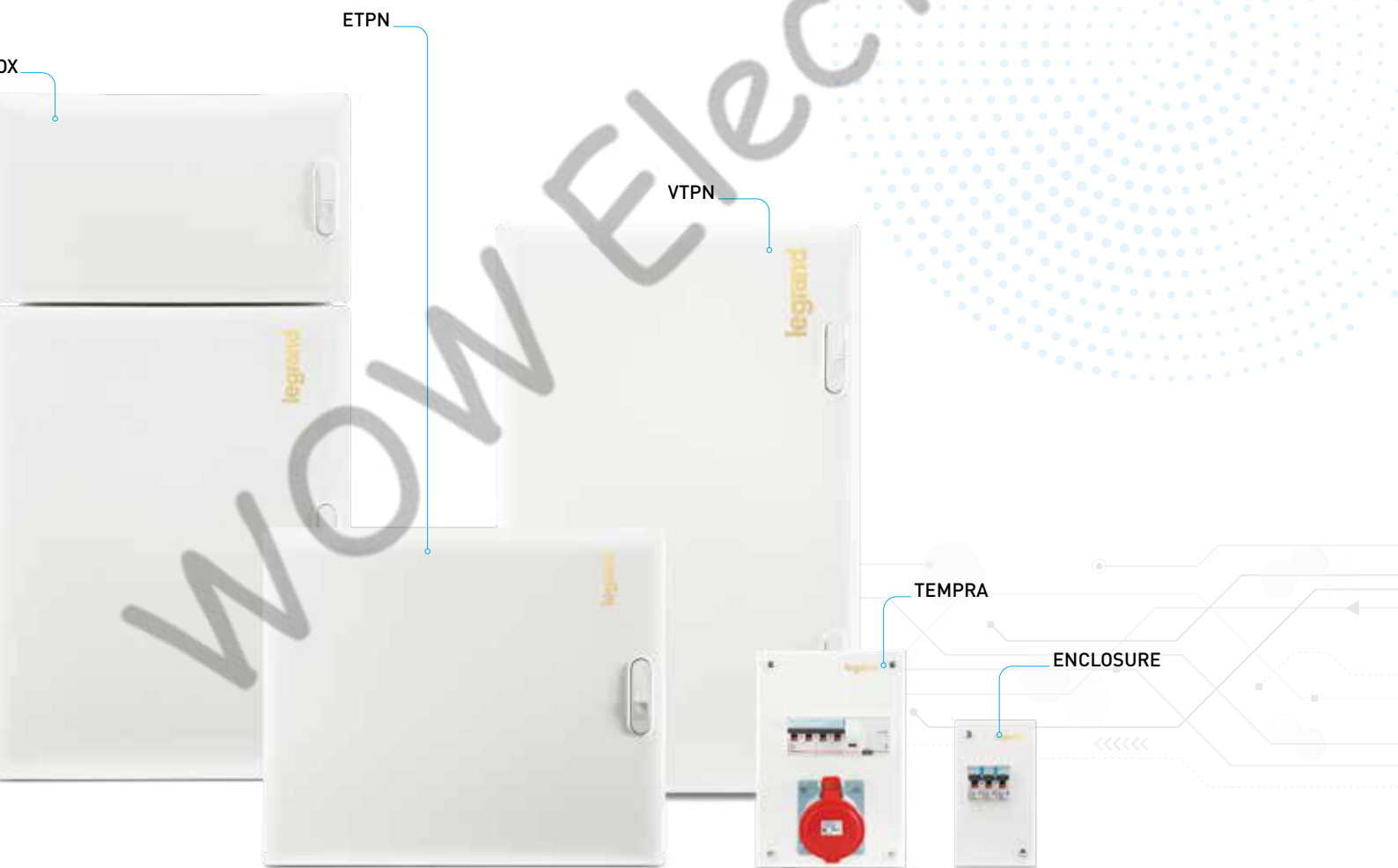

MIVAN CONSTRUCTION COMPATIBLE EKINOX³ DB



Mivan Construction Compatible Ekinox3 distribution boards are made with thick sheets to withstand extreme pressures during the Mivan construction process. The sleek, minimalistic and stylish design enhance the overall ambience of the spaces.

SALIENT FEATURES

- Easily removable knock outs for cable glanding
- Full proof solution
- Innovative door knob
- Integrated door earthing system
- Door separately packed
- Plain look with rounded corners
- Stronger glanding plates
- Nut inserts for longer installation life
- Increased sheet thickness to withstand Mivan Construction challenges
- Slimmest DB with 71 mm depth
- IP 43 degree of protection
- Wire set, Din rail components, Neutral and Earth bar packed separately in inner assembly set

MIVAN SPN DB

5076 10M	4W
5076 11M	8W
5076 12M	12W
5076 13M	16W
5076 15M	20W

MIVAN ETPN DB

5076 70M	4W ETPN IP43
5076 71M	6W ETPN IP43
5076 72M	8W ETPN IP43
5076 73M	12W ETPN IP43
5076 74M	16W ETPN IP43

TV/Telephone DBs available on request



Scan to know more about the product.

Ekinox³ SPN DB's

for DX³ MCB, Isolator, RCCB and RCBO

Cat.Nos	Number ofWs	No. of modules	MRP* ₹ / Unit	Pack
---------	-------------	----------------	---------------	------

- As per IEC 61439-3
- Suitable for Flush Mounting and Surface Mounting
- With 100 A Copper Busbar
- With Neutral bar, Earthbar and Cable ties for Cable management
- Fully shrouded Neutral bars
- Prefitted masking sheet
- Reversible Door for IP 43 & IP 54 DB's

IP 30 - #IK 08

5076 00	4W	4	1778	1
5076 01	8W	8	2160	1
5076 02	12W	12	2552	1
5076 03	16W	16	3116	1
5076 04	18W	18	3626	1
5076 05	20W	20	3726	1



5076 05



5076 82

IP 43 - #IK 09 with metal door

5076 10	4W	4	2344	1
5076 11	8W	8	2892	1
5076 12	12W	12	3476	1
5076 13	16W	16	4390	1
5076 14	18W	18	4532	1
5076 15	20W	20	5550	1



5076 12

IP 43 - #IK 09 with acrylic door

5076 20	4W	4	3132	1
5076 21	8W	8	3628	1
5076 22	12W	12	4408	1
5076 23	16W	16	5476	1
5076 24	18W	18	5726	1
5076 25	20W	20	6064	1



5076 42

IP 54 - #IK 09

5076 40	4W	4	8126	1
5076 41	8W	8	9660	1
5076 42	12W	12	11096	1
5076 43	16W	16	12324	1
5076 44	18W	18	12458	1
5076 45	20W	20	13538	1

Ekinox³ ETPN DB's

for DX³ MCB, Isolator, RCCB and RCBO

- As per IEC 61439-3
- Suitable for Flush Mounting and Surface Mounting
- With 100 A Copper Busbar for each phase
- With Neutral bar, Earthbar and Cable ties for Cable management
- Fully insulated busbar & shrouded Neutral bars
- Improved Pan assembly for ease of installation
- Prefitted masking sheet
- Reversible Door for IP 43 & IP 54 DB's
- With provision for FP MCB/Isolator/RCCB/RCBO as incomer and SP MCB's as outgoing
- Supplied with wireset
- Can be converted to PPI DB at site using conversion kit

IP 30 - #IK 08

5076 60	4W	8+12	4994	1
5076 61	6W	8+18	6196	1
5076 62	8W	8+24	7316	1
5076 63	12W	8+36	10432	1
5076 64	16W	8+48	12706	1
5076 66	20W	8+60	17732	1



5077 01



5077 11

Ekinox³ ETPN DB's

for DX³ MCB, Isolator, RCCB and RCBO

Cat.Nos	Number ofWs	No. of modules	MRP* ₹ / Unit	Pack
---------	-------------	----------------	---------------	------

IP 43 - #IK 09 with metal door

5076 70	4W	8+12	5776	1
5076 71	6W	8+18	7146	1
5076 72	8W	8+24	8630	1
5076 73	12W	8+36	12798	1
5076 74	16W	8+48	15870	1
5076 76	20W	8+60	22812	1

IP 43 - #IK 09 with acrylic door

5076 80	4W	8+12	7800	1
5076 81	6W	8+18	9538	1
5076 82	8W	8+24	11224	1
5076 83	12W	8+36	17384	1
5076 84	16W	8+48	20934	1
5076 86	20W	8+60	28300	1

IP 54 - #IK 09

5076 90	4W	8+12	19774	1
5076 91	6W	8+18	23794	1
5076 92	8W	8+24	26022	1
5076 93	12W	8+36	37030	1
5076 94	16W	8+48	44010	1
5076 96	20W	8+60	52356	1

Ekinox³ Flexy DB

for DX³ DIN modular products

Cat.Nos	Number of row	No. of modules	MRP* ₹ / Unit	Pack
---------	---------------	----------------	---------------	------

- As per IEC 61439-3
- Suitable for Flush Mounting and Surface Mounting
- Completely flexible to organise the distribution as per site requirements
- Busbars to be selected as per distribution requirements
- With Neutral and Earth bars
- Fully shrouded Neutral bars
- Improved Pan assembly for ease of installation
- Prefitted masking sheet
- Reversible door for IP 43

IP 30 - #IK 08

5077 01	2 row of 14 M	28	6054	1
5077 02	3 row of 14 M	42	7580	1
5077 03	4 row of 14 M	56	8404	1

IP 43 - #IK 09 with metal door

5077 05	2 row of 14 M	28	7304	1
5077 06	3 row of 4 M	42	8688	1
5077 07	4 row of 14 M	56	9464	1
5077 14	4 row of 8 M	32	7848	1
5077 15	4 row of 10 M	40	8216	1
5077 12	3 row of 14 M MCCB for DPX ³ 160 MCCB	42	9862	1

IP 43 - #IK 09 with acrylic door

5077 09	2 row of 14 M	28	7704	1
5077 10	3 row of 14 M	42	9466	1
5077 11	4 row of 14 M	56	10726	1
5077 13	3 row of 14 M MCCB for DPX ³ 160 MCCB	42	10972	1

* MRP - Maximum Retail Price Inclusive of all taxes including GST.
#IK - Refer pg - 59 for ready reckoner table.

Bold Cat.Nos are products normally available with Legrand (India) Stockists. Cat.Nos that are not bold - delivery within 4 - 8 weeks from the date of order. Bold packing quantity is our mandatory packing. Orders to be placed by Legrand (India) Stockist in multiples of the same.

Ekinox³ TPN DB-VTPN DB's

for DX³ MCB, Isolator, RCCB and RCBO

Cat.Nos	Number ofWs	No. of modules	MRP* ₹ / Unit	Pack
---------	-------------	----------------	---------------	------

- As per IEC 61439-3
- Suitable for Flush Mounting and Surface Mounting
- With 100 A Copper Busbar for each phase
- With 2 Neutral bar, 2 Earthbar and Cable ties for Cable management
- Fully insulated busbar & shrouded Neutral bars
- Improved Pan assembly for ease of installation
- Prefitted masking sheet
- Reversible Door for IP 43 & IP 54 DB's
- With provision for FP MCB/Isolator/RCCB/RCBO as incomer and SP/TP MCB's as outgoing

IP 30 - #IK 08

5077 20	4W	8+12	13294	1
5077 21	6W	8+18	14590	1
5077 22	8W	8+24	16230	1
5077 23	12W	8+36	23434	1

IP 43 - #IK 09 with metal door

5077 25	4W	8+12	14268	1
5077 26	6W	8+18	15802	1
5077 27	8W	8+24	18392	1
5077 28	12W	8+36	24746	1

IP 43 - #IK 09 with acrylic door

5077 30	4W	8+12	18698	1
5077 31	6W	8+18	20572	1
5077 32	8W	8+24	24056	1
5077 33	12W	8+36	32094	1

IP 54 - #IK 09

5077 35	4W	8+12	29970	1
5077 36	6W	8+18	32586	1
5077 37	8W	8+24	36048	1
5077 38	12W	8+36	46666	1

Ekinox³ TPN DB-VTPN DPX³ 160 MCCB DB's

- As per IEC 61439-3
- Suitable for Flush Mounting and Surface Mounting
- With 250 A Copper Busbar for each phase
- With 2 Neutral bar, 2 Earthbar and Cable ties for Cable management
- Fully insulated busbar & shrouded Neutral bars
- Improved Pan assembly for ease of installation
- Prefitted masking sheet
- Reversible Door for IP 43 & IP 54 DB's
- With provision for DPX³ 160 MCCB as incomer and SP/TP MCB's as outgoing

IP 30 - #IK 08

5077 40	4W	DPX ³ 160+12	15178	1
5077 41	6W	DPX ³ 160+18	16236	1
5077 42	8W	DPX ³ 160+24	17512	1
5077 43	12W	DPX ³ 160+36	26528	1

IP 43 - #IK 09 with metal door

5077 45	4W	DPX ³ 160+12	17258	1
5077 46	6W	DPX ³ 160+18	19588	1
5077 47	8W	DPX ³ 160+24	21580	1
5077 48	12W	DPX ³ 160+36	29420	1

* MRP - Maximum Retail Price Inclusive of all taxes including GST.
#IK - Refer pg - 59 for ready reckoner table.

Ekinox³ TPN DB-VTPN DPX³ 160 MCCB DB's

Cat.Nos	Number ofWs	No. of modules	MRP* ₹ / Unit	Pack
---------	-------------	----------------	---------------	------

IP 54 - #IK 09

5077 50	4W	DPX ³ 160+12	35170	1
5077 51	6W	DPX ³ 160+18	40048	1
5077 52	8W	DPX ³ 160+24	43508	1
5077 53	12W	DPX ³ 160+36	57318	1

Ekinox³ TPN DB-VTPN DPX³ 250 MCCB DB's

- As per IEC 61439-3
- Suitable for Flush Mounting and Surface Mounting
- With 250 A Copper Busbar for each phase
- With 2 Neutral bar, 2 Earthbar and Cable ties for Cable management
- Fully insulated busbar & shrouded Neutral bars
- Improved Pan assembly for ease of installation
- Prefitted masking sheet
- Reversible Door for IP 43 & IP 54 DB's
- With provision for DPX³ 250 MCCB as incomer and SP/TP MCB's as outgoing

IP 30 - #IK 08

5077 55	4W	DPX ³ 250+12	24302	1
5077 56	8W	DPX ³ 250+24	25836	1
5077 57	12W	DPX ³ 250+36	28516	1

IP 43 - #IK 09 with metal door

5077 58	4W	DPX ³ 250+12	27978	1
5077 59	8W	DPX ³ 250+24	32160	1
5077 60	12W	DPX ³ 250+36	33964	1

IP 54 - #IK 09

5077 61	4W	DPX ³ 250+12	41492	1
5077 62	8W	DPX ³ 250+24	47414	1
5077 63	12W	DPX ³ 250+36	55408	1

NEW!

Phase Selector Neo DB

- As per IEC 61439-3
- Compact and sleek design
- IP 43 protection & IK 09
- Integrated LED indication in the selector switches
- With 100A copper busbar for each phase
- Fully insulated busbar & shrouded Neutral bars

Cat.Nos	Description	MRP* ₹ / Unit	Pack
---------	-------------	---------------	------

Ekinox³ TPN DB- Phase selector NEO DB's For DX³ MCB Isolator, RCCB, RCBO

5077 80N	4W NEO	15466	1
5077 81N	6W NEO	15716	1
5077 82N	8W NEO	16838	1
5077 83N	12W NEO	18960	1

Bold Cat.Nos are products normally available with Legrand (India) Stockists. Cat.Nos that are not bold - delivery within 4 - 8 weeks from the date of order. Bold packing quantity is our mandatory packing. Orders to be placed by Legrand (India) Stockist in multiples of the same.

Ekinox³ TPN DB- 7/8 segment NEO DB's

for DX³ MCB, Isolator, RCCB and RCBO

Cat.Nos	Description	MRP* ₹ / Unit	Pack
---------	-------------	------------------	------

IP 42 - #IK 09 with metal door

- As per IEC 61439-3
- DB with phase segmentation and separation between Incomer and Outgoings
- Sturdy & Robust design
- With 100A copper busbar for each phase
- Colour coded Neutral Bars
- Easy to Install : Detachable frame
- 8 compartments
- More number of knockouts
- IP42 & IK09
- Supplied with wire-set
- With provision for DPX³ 160 MCCB as incomer DP MCB/Isolator/RCCB/RCBO as sub incomers and SP MCB's as outgoing

5078 85N	4W 8/7S IP42 Neo	11862	1
5078 86N	6W 8/7S IP42 Neo	13352	1
5078 87N	8W 8/7S IP42 Neo	14958	1
5078 88N	12W 8/7S IP42 Neo	18530	1

IP 42- #IK09 suitable for 160A DPX³ MCCB as incomer

5078 95N	4W 8/7S 160A MCCB IP42 Neo	16468	1
5078 96N	6W 8/7S 160A MCCB IP42 Neo	18840	1
5078 97N	8W 8/7S 160A MCCB IP42 Neo	21770	1
5078 98N	12W 8/7S 160A MCCB IP42 Neo	24580	1

Ekinox³ TPN DB - 7 segment DB's

for DX³ MCB, Isolator, RCCB and RCBO

- As per IEC 61439-3
- Separate compartment for incomer, sub-incomer & outgoing devices
- Suitable for Flush Mounting and Surface Mounting
- With 100 A Copper Busbar for each phase
- With Neutral bar, Earthbar and Cable ties for Cable management
- Fully insulated busbar & shrouded Neutral bars
- With provision for FP MCB/Isolator/RCCB/RCBO as incomer, DP RCCB/RCBO as sub incomer and SP MCB's as outgoing
- Supplied with wire set
- DB with phase segmentation and separation between incomer and outgoings

IP 30 - #IK 08

5078 80	4W	8+12+12	■	1
5078 81	6W	8+12+18	■	1
5078 82	8W	8+12+24	■	1
5078 83	12W	8+12+36	■	1

* MRP - Maximum Retail Price Inclusive of all taxes including GST.
■ Price available on request.
#IK - Refer pg - 59 for ready reckoner table.

Ekinox³ TPN DB - 7 segment DB's

for DX³ MCB, Isolator, RCCB and RCBO

Cat.Nos	Description	No. of modules	MRP* ₹ / Unit	Pack
---------	-------------	----------------	------------------	------

IP 43 - #IK 09 with metal door

5078 85	4W	8+12+12	■	1
5078 86	6W	8+12+18	■	1
5078 87	8W	8+12+24	■	1
5078 88	12W	8+12+36	■	1

Ekinox³ TPN DB - 7 segment DB's for 160 A DPX³ MCCB

- As per IEC 61439-3
- DB with phase segmentation and separation between incomer and Outgoings
- Suitable for Flush Mounting and Surface Mounting
- With 100 A Copper Busbar for each phase
- With Neutral bar, Earthbar and Cable ties for Cable management
- Fully Color Shrouded Insulated bus bar and Neutral bars
- With provision for DPX³ 160 MCCB as incomer DP MCB/Isolator/RCCB/RCBO as sub incomers and SP MCB's as outgoing
- Supplied with wire set

IP 30 - #IK 08

5078 90	4W	DPX ³	■	1
	160+12+12			
5078 91	6W	DPX ³	■	1
	160+12+18			
5078 92	8W	DPX ³	■	1
	160+12+24			
5078 93	12W	DPX ³	■	1
	160+12+36			

IP 43 - #IK 09 with metal door

5078 95	4W	DPX ³	■	1
	160+12+12			
5078 96	6W	DPX ³	■	1
	160+12+18			
5078 97	8W	DPX ³	■	1
	160+12+24			
5078 98	12W	DPX ³	■	1
	160+12+36			

Ekinox³ Metal enclosures

for DX³ MCB, RCCB, RCBO and DPX³ MCCB's

- As per IEC 61439-3
- Suitable for Flush Mounting and Surface Mounting
- Suitable for protection of appliances like AC/Geyser etc
- Supplied with Neutral Links
- With provision for mounting modular devices

#IK 08

5078 10	10 A SP, 2P+E	1	2278	1
5078 11	20 A SP, 2P+E	1	2454	1
5078 14	20 A DP, 2P+E	2	2666	1
5078 17	20 A TP, 3P+E	3	4518	1
5078 18	32 A TP, 3P+E	3	5360	1
5078 20	20 A DP RCBO, 2P+E	4	2580	1
5078 21	20 A FP RCBO, 2P+E	8	4510	1
5078 22	32 A FP RCBO, 3P+E	8	5318	1

Bold Cat.Nos are products normally available with Legrand (India) Stockists. Cat.Nos that are not bold - delivery within 4 - 8 weeks from the date of order. Bold packing quantity is our mandatory packing. Orders to be placed by Legrand (India) Stockist in multiples of the same.

Ekinox³ P-17 Tempra plug & socket DB's

for DX³ MCB, RCCB and RCBO

Cat.Nos	Description	No. of modules	MRP* ₹ / Unit	Pack
---------	-------------	----------------	---------------	------

- As per IEC 61439-3
- Suitable for Flush Mounting and Surface Mounting
- Supplied with Neutral Links
- With provision for mounting modular devices

#IK 08

5078 60	16 A 2P+E-DP	2	3722	1
5078 63	32 A 2P+E-DP	2	4022	1
5078 61	32 A 3P+E-FP	8	6734	1
5078 62	32 A 3P+N+E-FP	8	6812	1
5078 64	63 A 3P+N+E-FP	8	16954	1

Ekinox³ Metal enclosures

for DX³ MCB, RCCB, RCBO and DPX³ MCCB's

- As per IEC 61439-3
- For independent mounting of DX³ MCB, RCCB, RCBO, DPX³ 160, DPX³ 250, DPX³ 630 & DRX MCCB's
- #IK 08

#IK 08

5077 90	SP enclosure	1	634	1
5077 91	DP enclosure	2	912	1
5077 92	TP enclosure	3	908	1
5077 93	FP enclosure	4	912	1
5077 94	FP RCBO enclosure	8	1526	1

Metal oneW enclosures for MCCB

5078 01	DPX ³ 160 MCCB enclosure	3&4	5192	1
5078 02	DPX ³ 250 MCCB enclosure	3&4	9130	1
5078 04	DPX ³ 630 MCCB enclosure	3&4	13974	1
5078 05	DRX 100 MCCB enclosure-TP	3	2774	1
5078 06	DRX 100 MCCB enclosure-FP	4	2616	1

Ekinox³ cable end box

Cat.Nos	Description	MRP* ₹ / Unit	Pack
---------	-------------	---------------	------

- Useful for keeping extra cables
- Possible to mount on the top or bottom of the DB
- Provision for mounting terminal blocks
- Can be used as a terminal box adaptor also

For IP 30 DB's

5079 10	For SPN 4 W IP30	872	1
5079 12	For SPN 8 W IP30	1002	1
5079 14	For SPN 12 W/ VTPN/Flexy	1144	1
5079 16	For SPN 16 W/ ETPN 6W DB	1598	1
5079 25	For ETPN 8W DB	2886	1
5079 27	For ETPN 12W DB	3738	1
5079 29	For ETPN 16W DB	3696	1
5079 31	For ETPN 18W DB	4080	1
5079 33	For ETPN 20W DB	4064	1
5079 35	For ETPN 4W VTPN/FLEXY MCB	1122	1
5079 37	For all VTPN MCCB DBS	4174	1

* MRP - Maximum Retail Price Inclusive of all taxes including GST.

▼ Compatible with Ekinox3 and NEO DB.

#IK - Refer pg - 59 for ready reckoner table.

Ekinox³ Metal enclosures

for DX³ MCB, RCCB, RCBO and DPX³ MCCB's

Cat.Nos	Description	MRP* ₹ / Unit	Pack
---------	-------------	---------------	------

For IP 43 DB's

5079 11	For SPN 4W DB	996	1
5079 13	For SPN 8W DB	1214	1
5079 15	For SPN 12W/ VTPN/Flexy DB	1362	1

For IP 43 DB's

5079 17	For SPN 16W/ ETPN 6W DB	1934	1
5079 18	For SPN 18W DB	1936	1
5079 19	For SPN 20/ETPN 8W DB	2022	1
5079 28	For ETPN 12W DB	4340	1
5079 30	For ETPN 16W DB	4422	1
5079 32	For ETPN 18W DB	4686	1
5079 34	For ETPN 20W DB	4768	1
5079 36	For all ETPN 4W/VTPN/Flexy MCB	1362	1
5079 38	For all VTPN MCCB DBs	4834	1
5079 00▼	For 7 segment 4W DB	4104	1
5079 01▼	For 7 segment 6W DB	4504	1
5079 02▼	For 7 segment 8W DB	5024	1
5079 03▼	For 7 segment 12W DB	5678	1

Ekinox³ DBs

meter box

- Suitable for Mounting DX³ Metering products
- Possible to mount on the top or bottom of the DB
- Provision for mounting Ammeter/Voltmeter/ASS/VSS
- #IK09

Provision for mounting meters

5079 40	For VTPN MCB INCOM IP 30	5506	1
5079 41	For VTPN MCB INCOM IP 43	6758	1
5079 42	For VTPN MCCB INCOM IP 30	6122	1
5079 43	For VTPN MCCB INCOM IP 43	7798	1

Per phase Isolation kit

5079 44	PPI conversion kit for ETPN 4W DB	3358	1
5079 45	PPI conversion kit for ETPN 6W DB	3786	1
5079 46	PPI conversion kit for ETPN 8W DB	4338	1
5079 47	PPI conversion kit for ETPN 12W DB	4880	1
5079 48	PPI conversion kit for ETPN 16W DB	5430	1

Panel locks

5079 52	Panel knob for IP 43	370	1
5079 51	Panel knob with key	772	1

Bold Cat.Nos are products normally available with Legrand (India) Stockists. Cat.Nos that are not bold - delivery within 4 - 8 weeks from the date of order. Bold packing quantity is our mandatory packing. Orders to be placed by Legrand (India) Stockist in multiples of the same.

Ekinox™ distribution boards

Cat.Nos	Number ofWs	MRP* ₹ / Unit	Pack
---------	-------------	------------------	------

Plexo3 boxes for DX³

Self-extinguishing: resistance to incandescent wire 650 °C

Conform to EN 60439-3

Weatherproof cabinets - IP 65 - IK 09 - Class II

Door and cabinet fully reversible

Removable chassis and faceplates from 2-row versions up

2-position rail for modular products and moulded cases

Spacing between rails 150 mm

Box colour light grey L750A, cover colour dark grey R746A



6019 94

6019 32	2 (+1) Module	2048	1
6019 94	4 Module	2212	1
6019 96	6 Module	2526	1
6019 98	8 Module	3156	1



6018 32

Cabinets with 12 modules per row

6018 31	1 row 12 modules	4972	1
6018 32	2 rows 24 modules	6898	1
6018 33	3 rows 36 modules	9614	1

Cabinets with 18 modules per row

6018 35	18 modules x 1 row	6132	1
6018 36	18 modules x 2 rows	10612	1
6018 37	18 modules x 3 rows	14920	1
6018 38	18 modules x 4 rows	22332	1



6018 32 +
0019 17

Multifunction sleeves for P17

0019 17	For 2 row cabinets	3944	1
0019 18	For 3 row cabinets	5912	1
0019 67	Joining kit	1116	1

Ekinox³
Smart Solutions

Metra Plug & Socket DB's

The Right Choice for all your application needs



Note: For Plexo3 Box with integrated Neutral & Earth Bars contact nearest Sales Office

* MRP - Maximum Retail Price Inclusive of all taxes including GST.

Refer instruction manual for MIVAN (Aluminum shuttering) compatible DB's

Distribution boards

Cat.Nos	No. of devices connected	No. of 17.5 mm modules	MRP* ₹ / Unit	Pack
---------	--------------------------	------------------------	------------------	------

Supply busbars - insulated

63 A copper

Pin type

SP I/C & SP O/G

4049 26	13	13	408	1
4049 37	57	57	1586	1

SPN I/C & SPN O/G

4049 38	6	12	718	1
4049 39	28	56	2966	1

TPN I/C & SPN O/G

4049 40	5	12	738	3/30
4049 41	27	56	7240	5/10

TP I/C & TP O/G

4049 42	4	12	744	1
4049 43	19	57	7278	1

FP I/C & FP O/G

4049 44	3	12	1788	3/30
4049 45	14	56	7240	5/10

Fork type

SP I/C & SP O/G

4049 11	13	12	408	1
4049 12	57	57	1556	1

SPN I/C & SPN O/G250

4049 14	28	56	2966	1
---------	----	----	------	---

TP I/C & TP O/G

4049 17	4	12	738	1
4049 18	19	57	3724	1

FP I/C & FP O/G

4049 20	14	56	7240	5/10
---------	----	----	------	------

Cat.Nos	Description	MRP* ₹ / Unit	Pack
---------	-------------	------------------	------

Accessories for fork and pin type busbars

4049 89	End caps for SP	8	6
4049 90	End caps for DP & TP	48	6
4049 91	End caps for FP	88	20/840

Cat.Nos	Number ofWs	MRP* ₹ / Unit	Pack
---------	-------------	------------------	------

Blanking plates

6014 70	-	16	10
---------	---	----	----

Bold Cat.Nos are products normally available with Legrand (India) Stockists. Cat.Nos that are not bold - delivery within 4 - 8 weeks from the date of order. Bold packing quantity is our mandatory packing. Orders to be placed by Legrand (India) Stockist in multiples of the same.

Ekinox³

For converting ETPN DB to PPI DB

PPI DB IP 30 - IK 08

No. of ways	Combine		No. of modules
	ETPN DB	PPI Kit	
4 way	4 way 507660	4 way kit 507944	8+12
6 way	6 way 507661	6 way kit 507945	8+18
8 way	8 way 507662	8 way kit 507946	8+24
12 way	12 way 507663	12 way kit 507947	8+36
16 way	16 way 507664	16 way kit 507948	8+48

PPI DB IP 43 - IK 09 with metal door

No. of ways	Combine		No. of modules
	ETPN DB	PPI Kit	
4 way	4 way 507670	4 way kit 507944	8+12
6 way	6 way 507671	6 way kit 507945	8+18
8 way	8 way 507672	8 way kit 507946	8+24
12 way	12 way 507673	12 way kit 507947	8+36
16 way	16 way 507674	16 way kit 507948	8+48

PPI DB IP 43 - IK 09 with acrylic door

No. of ways	Combine		No. of modules
	ETPN DB	PPI Kit	
4 way	4 way 507680	4 way kit 507944	8+12
6 way	6 way 507681	6 way kit 507945	8+18
8 way	8 way 507682	8 way kit 507946	8+24
12 way	12 way 507683	12 way kit 507947	8+36
16 way	16 way 507684	16 way kit 507948	8+48

PPI DB IP 54 - IK 09

No. of ways	Combine		No. of modules
	ETPN DB	PPI Kit	
4 way	4 way 507690	4 way kit 507944	8+12
6 way	6 way 507691	6 way kit 507945	8+18
8 way	8 way 507692	8 way kit 507946	8+24
12 way	12 way 507693	12 way kit 507947	8+36
16 way	16 way 507694	16 way kit 507948	8+48

IK

Protection against mechanical impact: protection index - IK

According to standard:

IEC 62262, BS EN 62262 and NF EN 62262

• This table can be used to ascertain the resistance of a product to an impact given in Joules from the IK code (graduated from 00 to 10)

It can also be used to ascertain the correspondence with the old IP code 3rd digit and the corresponding external "Ag" conditions

IK	Tests	Impact energy (in Joules)	"AG" of NF C 15-100
IK 00		0	
IK 01		0.15	
IK 02		0.2	AG1
IK 03		0.35	
IK 04		0.5	
IK 05		0.7	
IK 06		1	
IK 07		2	AG2
IK 08		5	AG3
IK 09		10	
IK 10		20	AG4

IPXX

Index of protection

IP*** index of protection of enclosures of electrical equipment in accordance with standards IEC 529, BS 5490, DIN 400 50 and NF C 20-010

Up to 1000 V± and 1500 V= (standard UTE C 20 010)

1st figure:- protection against solid bodies

IP	tests	
0		No protection
1		Protected against solid bodies larger than 50 mm (eg:- accidental contact with the hand)
2		Protected against solid bodies larger than 12 mm (eg:- finger)
3		Protected against solid bodies larger than 2.5 mm (eg:- tools, wires)
4		Protected against solid bodies larger than 1 mm (eg:- fine tools and small wires)
5		Protected against dust (no harmful deposit)
6		Completely protected against dust

2nd figure:- protection against liquids

IP	tests	
0		No protection
1		Protected against vertically-falling drops of water (condensation)
2		Protected against drops of water falling at up to 15° from the vertical
3		Protected against drops of rain water at up to 60° from the vertical
4		Protected against projections of water from all directions
5		Protected against jets of water from all directions
6		Protected against jets of water of similar force to heavy seas
7		Protected against the effects of immersion
8		Protected against prolonged effects of immersion under pressure

The contents of all the above charts are for guidance only, if you have any doubt as to the interpretation of the information contained therein, please refer either to the standard itself or contact Legrand.

In accordance with our policy of continuous improvement, Legrand reserves the right to change specifications and designs without notice. All information given here is correct at the time of going to press.

SUPER COMPACT (SCP)

THE POWER SOLUTIONS FOR INDUSTRIAL AND SERVICE SECTOR APPLICATION

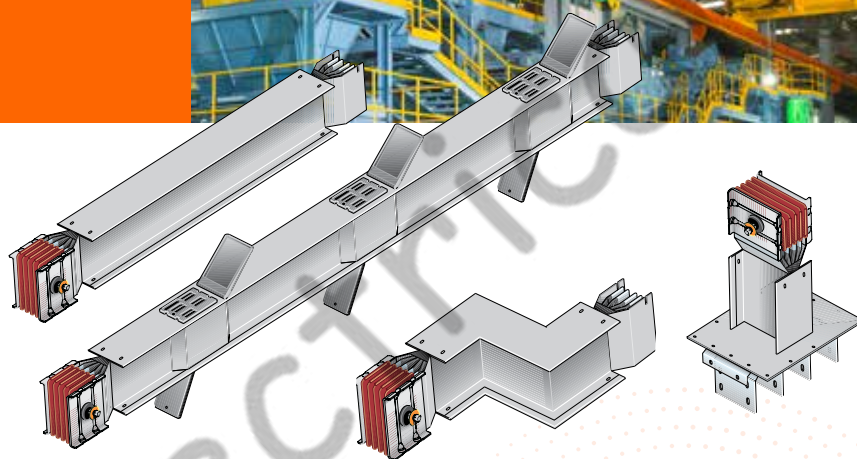

FEATURES

- Availability in the standard range from 630 A to 5000 A* with Aluminum alloy conductors and from 800 A to 6300 A* with copper conductors.
- Low impedance of the circuit;
- Availability with a wide selection of tap-off boxes that range from 63 A upto 1250 A, thus allowing you to locally protect and feed different types of loads by housing protective devices such as fuses, MCCBs and motorized switches.
- Compliance with the IES 61439-6 standard

ULTRA- COMPACT SIZES

- The super-compact dimensions enhance its resistance to short circuit stresses; in addition. They can reduce the impedance of the circuit by controlling the voltage drops and allow for the installation of high power electrical systems, even in extremely confined spaces.



Horizontal elbow



Vertical elbow



Connection interface



Junction



Scan to know more about the product.

ARTEOR™

VERSATILITY AND A
GLOBAL VISION FOR ANY
INSTALLATION LEVEL

Arteor™ is the innovative answer to the increasingly complex requirements in the building business all over the world. Arteor™ excels by its unique aesthetics and a rich choice of innovative designs and ergonomical options. The range extends from wiring devices, through innovative IoT based solutions, up to fully networked home automation systems based on BUS technology, which can also be integrated into third party solutions.



Scan to know more about
the product.

ARTEOR™

DESIGN FOR A GLOBAL LIFESTYLE



DESIGN OPTIONS FOR CONTROL FUNCTIONS

Arteor™ offers a wide choice of ergonomics and finishes to satisfy the most demanding customers. All stand-alone control functions are available in two shapes of rockers – round or square – and in three colours – white, magnesium and champagne.



Round rocker
White



Round rocker
Magnesium



Round rocker
Champagne



Square rocker
White



Square rocker
Magnesium



Square rocker
Champagne



ARTEOR™

HOME

THE IDEAL SOLUTION,
ALWAYS AND
EVERYWHERE

Its versatility makes Arteor™ the ideal choice for every kind of project, anywhere in the world at any installation level. Arteor™ suits any requirement in terms of design and function for every kind of building, from residential to commercial.



TV socket



Skirting light



1-way switch - 3 gang



Power unit



6AX switch*



Skirting light



USB charger



MODERN HOME



Triple RCA socket



Time delay switch

*Switch compatible with LED light

ARTEOR™

OFFICE AND HOTEL SOLUTIONS

Offices and collective spaces require specific solutions and maximum flexibility: lighting adapted to each situation (meeting, conference, etc.), access security, comprehensive multimedia connections. The Arteor™ range meets all these expectations with perfect adaptability.

OFFICE

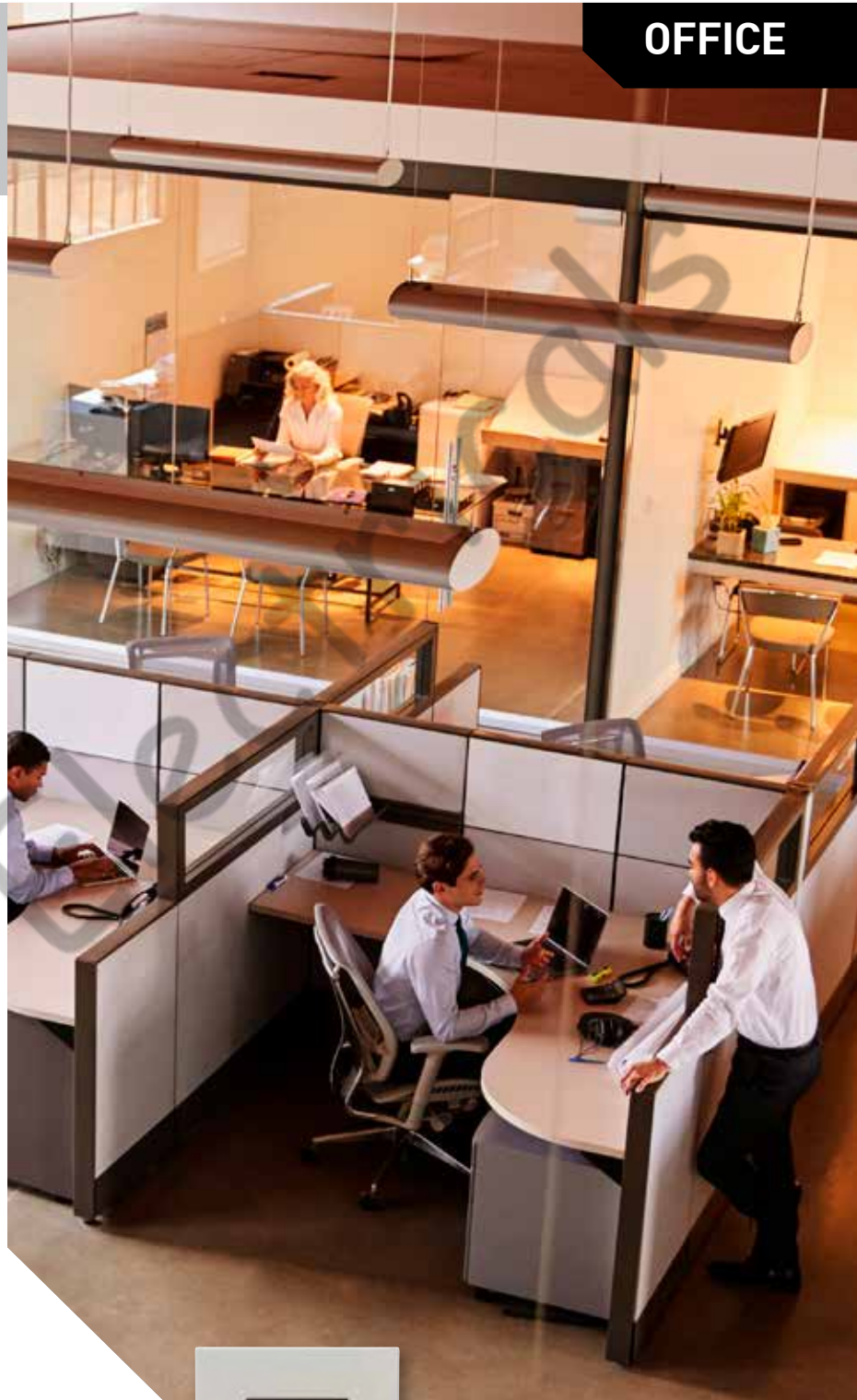

Automatic switch



6 A 1 way switch



USB socket



RJ45



Preterminated HDMI sockets



Female HD15 + Jack



Universal dimmer*

*For all loads including LED

HOTEL

From hotel room door to the beside table, Arteor™ provides all the solutions for the specific need of today's hotel industry. Comfort that extends to the hotel's communal areas, whether dedicated to the relaxation or work. The multitude of small details, gives the comfort feeling of being at home to the traveller.



Data sockets



4-Scenario touch control



S-Video socket



Keycard switch



External unit



Desk and entrance light



Bed light and curtain aswitch



Internal unit

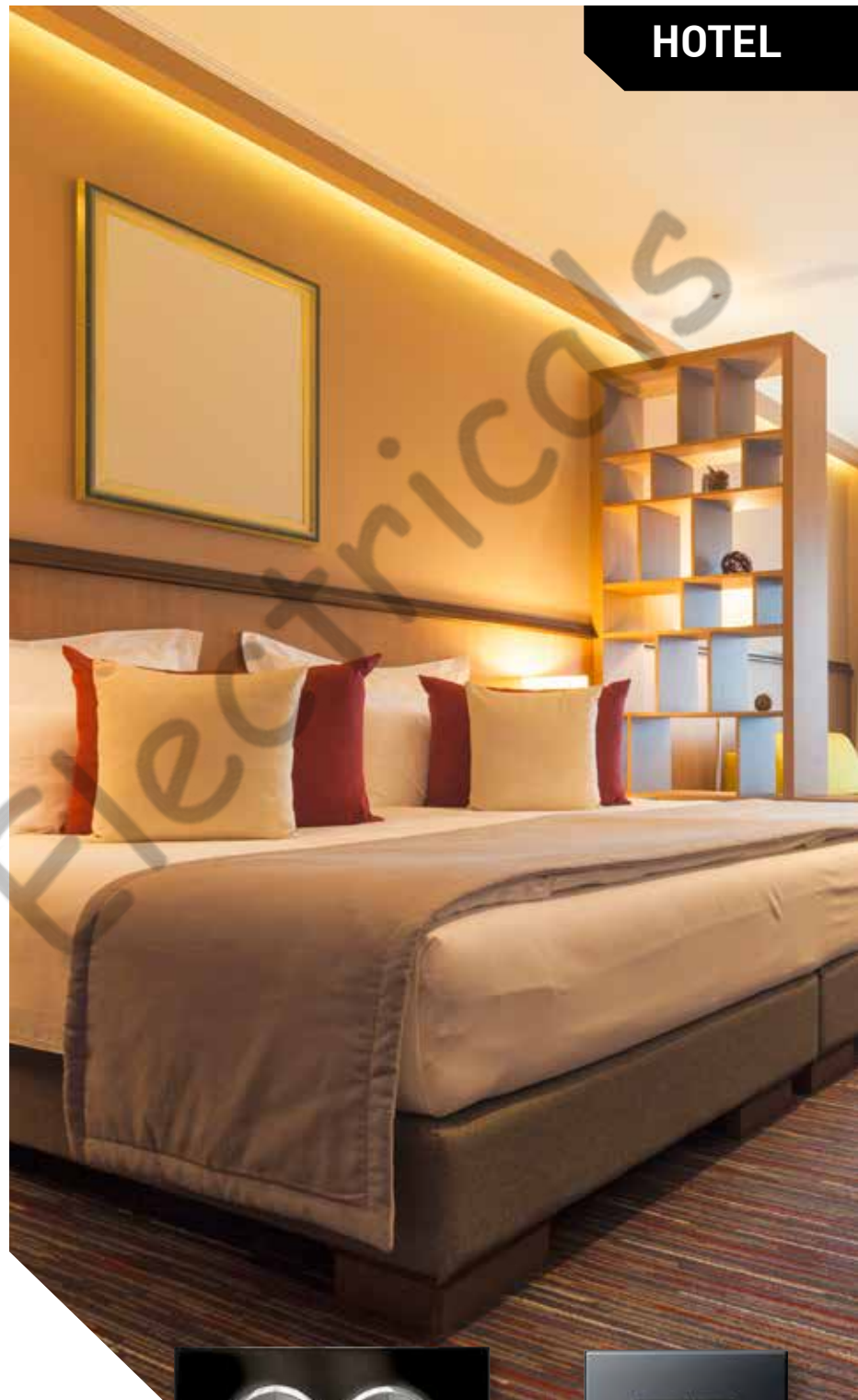

ARTEOR™

A RICH CHOICE
OF FINISHES

NEUTRAL

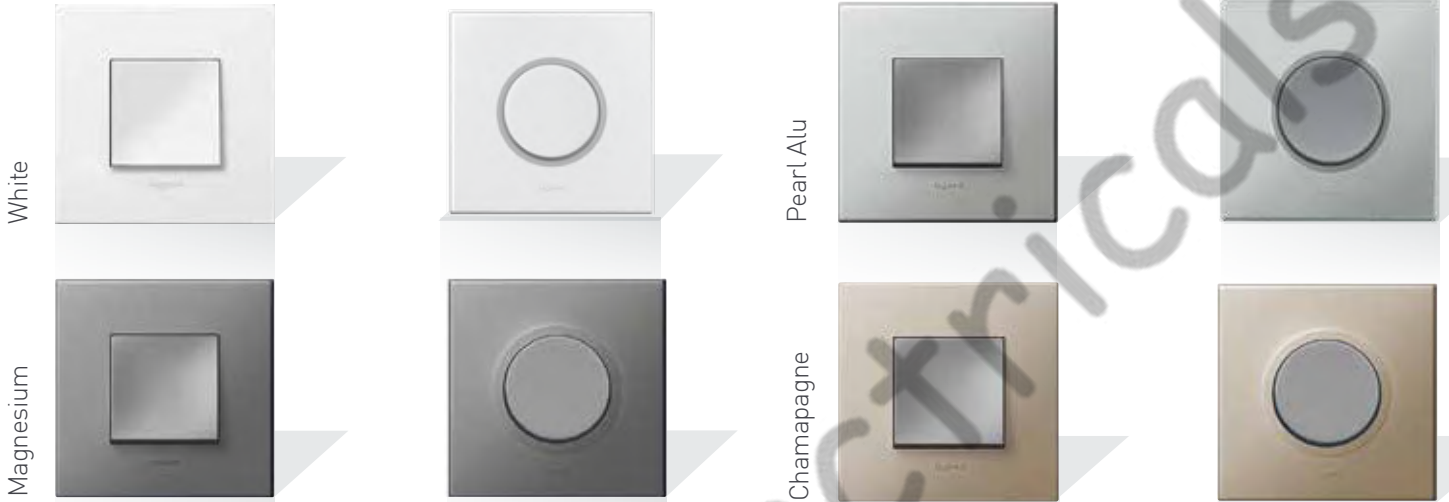

MIRROR

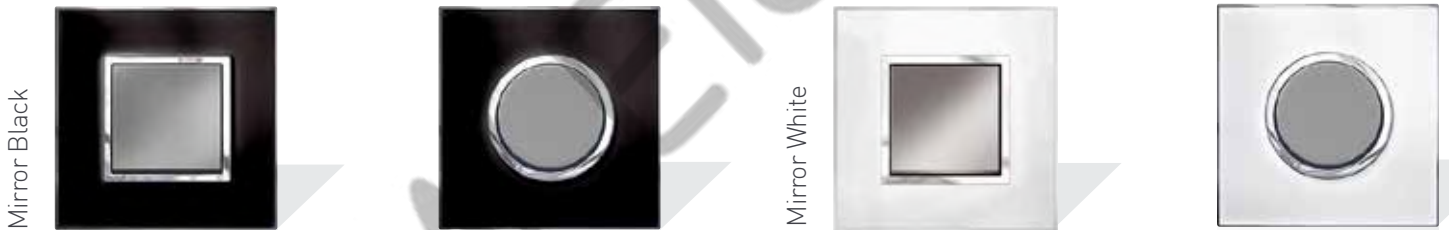

GRAPHIC



METAL



Graphite



Dark Bronze



Green Apple



Dark Barque



WOOD

Grey Oak



SIGNATURE

Cube



ARTEOR™

VERSATILITY AND
MODULARITY FOR
UNRIVALLED
FLEXIBILITY

Arteor™ is a modular range offering maximum flexibility in terms of installation and configuration.



Features that set ARTEOR™ apart



- ① Finger-proof terminals for IP 20 protection against accidental contact.
- ② Captive "never to loose screws"



- ① Tunnel terminals preventing screwdrivers from slipping.
- ② Laser marking on mechanisms. Arrow showing the correct orientation of the mechanism.
- ③ The latest IS 3854 : 1997.

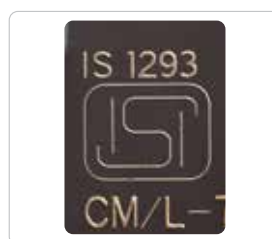

Sockets with ISI* mark, conforming to IS 1293. Fan regulator with ISI* mark, conforming to IS 11037.



Fully shrouded internal mechanism under the rocker preventing visibility of sparks.



- ① Stripping templates on sockets for stripping off exact length of insulation.



Sockets are shuttered for child's safety against electric shocks.



Possibility of weather proofing mechanisms using Plexo IP 55 and IP 66 boxes.



For switches with LED lamps, life of LED is 50000 burning hours. Consumes power (0.76W) next to NIL.

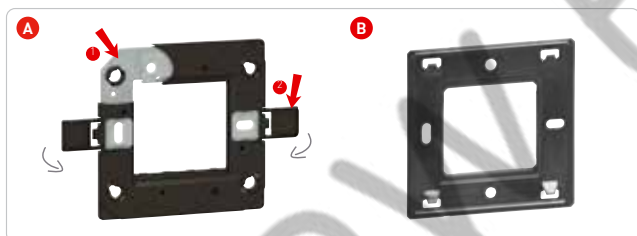

A. For all high end plates
Metal frame providing solid support to base.
Bi-material frame - electrical safety IP20.
Screw caps can be closed once the support frame is installed, ensuring total insulation.



2x2 way switch - 3 controls possible in 2 module plate. In round and square design possible.



Mechanisms compatible with DLP trunking systems, columns, floor boxes and VDI installations.

*Please referred to the description for ISI mark sockets and Fan Regulators.

ARTEOR™ MyHOME_UP

THE BEAUTIFUL SIMPLICITY OF HOME AUTOMATION

Put the finishing touch to your homes with the hometouch screen. get total control of your home with just a touch. see the full range of home automation solutions provided by arteor MyHOME_Up on legrand.co.in



THE FINISHING TOUCH



Arteor™ square - white mechanisms

Cat.Nos	Description	MRP* ₹ / Unit	Pack
---------	-------------	------------------	------

Switches – 6 A - 250 V AC

5734 00	Switch - 6 A - SP - 1 way 1 module	210	20/200
5734 01	Switch - 6 A - SP - 1 way with indicator - 1 module	360	20/200
5734 02	Switch - 6 A - SP - 2 way 1 module	320	20/200
5734 03	Switch - 6 A - SP - 2 way with indicator - 1 module	452	20/200

Switches – 10 A - 250 V AC

5734 50	Switch - 10 A - SP - 1 way 2 module	370	10/100
5734 51	Switch - 10 A - SP - 2 way 2 module	438	10/100
5720 37	Switch - 10 A - SP - 2 way with indicator & label holder - 2 module	2076	10/100
5720 38	Intermediate switch - 2 module	2486	10/100

Switches – 20 A - 250 V AC

5734 10	Switch - 20 A - SP - 1 way - 1 module	424	20/200
5734 52	Switch - 20 A - SP - 1 way - 2 module	504	10/100
5720 63	Switch - 20 A - SP - 1 way with indicator - 1 module	436	20/200
5734 11	Switch - 20 A - SP - 2 way with indicator - 1 module	610	20/200
5720 42	Switch - 20 A - SP - 2 way with indicator - 2 module	664	10/100
5720 43	Switch - 20 A - 3 gang - 1 way - 2 module	1194	10/100
5720 44	Switch - 20 A - 3 gang - 2x2 way + 1x1 way - 2 module	1306	10/100
5734 54	Switch - 20 A - DP - 1 way with indicator - 2 module	938	10/100
5720 49	Switch - 20 A - DP - 1 way with indicator and water heater marking - 2 module	984	10/100

Accessory for switch with indicator

5738 06	LED for switch with indicator (blue)	74	5/50
---------	---	----	------

Switches – 25 A - 230 V AC

5734 17	25 A switch with indicator	566	20/200
---------	----------------------------	-----	--------

Switches – 32 A / 40 A - 250 V AC

5734 12	Switch - 32 A - DP - 1 way with indicator - 2 module	1338	10/100
5735 30	Switch - 40 A - DP - 1 way with indicator - fits on 1/2 module box	1544	1/5/20

* MRP - Maximum Retail Price Inclusive of all taxes including GST.
■ Price available on request

Arteor™ square - white mechanisms

Cat.Nos	Description	MRP* ₹ / Unit	Pack
---------	-------------	------------------	------

Push button – 6 A - 250 V AC

5734 13	Bell push - 6 A - SP - 1 way - 1 module	342	20/200
5734 59	Bell push - 6 A - SP - 1 way - 2 module	480	10/100
5734 04	Push button - 6 A - SP - 1 way - 1 module	360	20/200
5734 05	Push button - 6 A - SP - 1 way with indicator - 1 module	456	20/200
5734 14	Bell push - 6 A - SP - 1 way with indicator - 1 module	452	20/200
5734 60	Bell push - 6 A - SP - 1 way with indicator - 2 module	644	10/100

Electric roller blinds control

5722 20	Double switch for electric shutter - 2 module	836	10/100
---------	--	-----	--------

Dimmers and fan regulators

5734 62	Light dimmer 60 to 400 watts - 2 module	1344	10/100
5734 16	Fan step regulator 100 watts (ISI) - 1 module	1106	1/5/50
5734 63	Fan step regulator 100 watts (ISI) - 2 module	1368	1/10/100
5734 69	Fan step regulator 120 watts (ISI) - 2 module (for 48 & 56" fans)	1460	1/10/100
5734 68	Fan step regulator - 2 module for energy saving fans	1456	1/10/100
5736 53	Fan regulator - 8 Step - 100W - 2 module	1302	1/10/100

Bold Cat.Nos are products normally available with Legrand (India) Stockists.
Cat.Nos that are not bold - delivery within 4 - 8 weeks from the date of order.
Bold packing quantity is our mandatory packing. Orders to be placed by
Legrand (India) Stockist in multiples of the same.

Arteor™

square - white mechanisms

Cat.Nos	Description	MRP* ₹ / Unit	Pack
---------	-------------	------------------	------

Electronic dimmers

5722 39	Universal dimmer without neutral 400 W - 2 module	12324	1/10
---------	---	-------	------



5722 39

Indian standard sockets

5734 71	Socket shuttered - 6/16 A - 3 pin - ISI Indian - 2 module	562	10/100
5734 67	Socket shuttered - 6/16 A - 3 pin - ISI Indian - 3 module	674	5/50
5735 10	Socket with switch - 16 A - 3 pin - 2P+E - Indian - 3 module	1584	5/50
5734 66	25 A socket - 2 module	684	10/100
5734 24	Socket - 6A - ISI - 3 pin-2 module	278	1/20/200



5734 71



5734 66



5738 88

Energy plugs

5738 86	6 A plug	136	1/10/100
5738 88	16 A plug	180	1/10/100
5738 07	25 A plug	206	1/10/100

USB chargers (IS13252 (Part 1) / IEC 60950-1)

5734 41	USB Charger 1500mA Type A, 1 module	2180	1/5/50
5734 36	USB Charger 1500mA Type C, 1 module	2200	1/5/50
5734 22	Double USB Charger 2400mA	3026	1/10/100

NEW!



5734 22

Combi (Socket + USB)

5734 18	Combi twin USB charger 3.1A type A & A with Euro Socket - 2 module	2238	1/10/100
5734 19	Combi twin USB charger 3.1A type A & C with Euro Socket - 2 module	2610	1/10/100
5734 20	Combi twin USB charger 3.1A type C & C with Euro Socket - 2 module	3394	1/10/100
5734 07	Combi twin USB CHARGER 3.1A Type A & C with Multistandard Socket - 3 Module	3680	1/5/20
5734 08	Gang Unit-6 A Multistandard Switched socket with USB 3100mA type A-2M	3368	1/10
5734 09	Gang Unit-6 A Multistandard Switched socket with USB 3100mA type A + C-4M	4648	1/5/20

NEW!

NEW!

NEW!

Arteor™

square - white mechanisms

Cat.Nos	Description	MRP* ₹ / Unit	Pack
---------	-------------	------------------	------

RJ 11 telephone sockets (Jack type)

5734 27	Telephone socket - double RJ11 - 1 module	500	20/200
5734 26	Telephone socket - RJ11 with shutter - 1 module	292	20/200



5734 27



5734 75



5734 25



5734 43

Information outlets - toolless

5734 29	Information socket - category 5e-UTP - 1 module	632	20/200
5734 75	Information socket - category 5e-UTP - 2 module	674	10/100
5734 28	Information socket - category 6-UTP - 1 module	966	20/200
5734 74	Information socket - category 6-UTP - 2 module	1014	10/100

TV sockets

5734 25	TV Co-Axial socket - 1 module	302	20/200
---------	-------------------------------	-----	--------

Electronic chime

5734 43	Bell ding dong 230V - 2 module	458	1/10/100
---------	--------------------------------	-----	----------

Buzzer

5734 42	Buzzer - 230 V - 1 module	1636	20/200
---------	---------------------------	------	--------

Bell call indicator & register - 6A - 250V AC

5734 15	Bell call indicator with register - 6 A - 1 way - SP - 1 module	2048	20/200
5736 06	Set of labels for bell call indicator (1-20)	552	5/50

Lighting

5734 64	Skirting light with LED - 230 V - 3 module	1100	1/5/25
5722 26	Skirting light with detector (LED) - 230 V - 2 module	16766	1/20
5724 53	Over door light unit (Red) 2 module	618	10/100
5722 23	Over door light unit (White) 2 module	506	10/100
5724 52	Indicator unit with transparent LED with coloured labels - 1 module	824	10/100



5722 26



5724 53



5724 52

Power strip and power units

5735 42	1 Power unit (AC & Geyser) 16 A - 4 module	1786	1/5
5721 54	Power unit (AC & Geyser) 32 A (with cable output)	2010	1/5

MCB

5723 61	MCB - 16 A-SPN - 2 module	4672	1
---------	---------------------------	------	---



5735 42

* MRP - Maximum Retail Price Inclusive of all taxes including GST.
■ Price available on request

Bold Cat.Nos are products normally available with Legrand (India) Stockists. Cat.Nos that are not bold - delivery within 4 - 8 weeks from the date of order. Bold packing quantity is our mandatory packing. Orders to be placed by Legrand (India) Stockist in multiples of the same.

Arteor™

square - white mechanisms

Cat.Nos	Description	MRP* ₹ / Unit	Pack
---------	-------------	------------------	------

Hotel "DND and MMR" functions

5734 61	DND and MMR indicator with bell push 1+1 module	2200	5/50
5734 58	Internal control unit for DND & MMR 1+1 module	1578	10/100

Hotel keycard switch

5722 44	16 A key card switch 230 V 2 module	6002	1/20
5722 59	Key fob for above	1636	10/50

Shaver socket

5721 53	Shaver socket 230 V / 120 - 230 V with earth connector	6240	1
---------	--	------	---

Time switch

5720 55	Time delay switch 2 module	7774	1/20
---------	----------------------------	------	------

Audio-video sockets

5722 72	Double RCA socket (audio) 1 module	4658	1/20
5722 73	Triple RCA socket (audio & video) 1 module	4176	1/20
5722 74	Female 3.5 mm Jack - 1 module	4632	1/20
5722 76	Female BNC 75 jack - 1 module	4888	1/20
5722 83	Female XLR jack - 2 module	7186	1/20
5720 97	Preterminated sockets Female HD15 - 1 module	6450	1
5720 96	Preterminated sockets HDMI 1.4 - 1 module	7654	1
5722 84	Line dying down 100 V (25-30W) 2 module	11972	1
5722 77	Male XLR jack 2 module	6574	1/20
5722 78	Female 3.5 mm Jack - solder - 1 module	3822	1/20
5722 75	USB socket - 1 module	3600	1/20
5722 88	Female HD15 + Jack 3.5 mm - 2 module	5194	1/20

Cable outlet

5734 80	45 A cable outlet 2 module	1224	5/50
5734 33	Cord outlet with 8 mm diameter - 1 module	388	20/200
5734 79	Standard cord outlet - 2 module	558	10/100

Blanking plate

5734 49	1 module blank	58	20/200
5723 44	2 modules blank	86	10/100
5758 10	Blanking plate + frame - 2 module	520	10/100

* MRP - Maximum Retail Price Inclusive of all taxes including GST.
 ■ To be Introduced Shortly
 (1) Supplied with white plate
 ■ Price available on request

Arteor™

square - white mechanisms

Cat.Nos	Description	MRP* ₹ / Unit	Pack
---------	-------------	------------------	------

Mounting accessories for panel

5760 15	Panel mounting support - 1 module	326	10/100
5760 16	Panel mounting support - 2 module	344	10/100
5760 50	DIN rail support 2 module	410	10/100

Square - magnesium mechanisms

Switches - 6 A - 250 V AC

5736 00	Switch - 6 A-SP - 1 way - 1 module	244	20/200
5736 01	Switch - 6 A-SP - 1 way with indicator - 1 module	414	20/200
5736 02	Switch - 6 A-SP - 2 way - 1 module	370	20/200
5736 03	Switch - 6 A-SP - 2 way with indicator - 1 module	528	20/200

Switches - 10 A - 250 V AC

5736 50	Switch - 10 A-SP - 1 way - 2 module	396	10/100
5736 51	Switch - 10 A-SP - 2 way - 2 module	468	10/100
5725 37	Switch - 10 A-SP - 2 way with indicator & label holder- 2 module	2340	10/100
5725 38	Intermediate switch - 2 module	2862	10/100

Switches - 20 A - 250 V AC

5736 10	Switch - 20 A-SP - 1 way 1 module	480	20/200
5736 52	Switch - 20 A-SP - 1 way 2 module	564	10/100
5725 63	Switch - 20 A-SP - 1 way with indicator -1 module	504	20/200
5736 11	Switch - 20 A-SP - 2 way with indicator -1 module	690	20/200
5725 42	Switch - 20 A-SP - 2 way with indicator - 2 module	740	10/100
5725 43	Switch - 20 A-3 gang - 1 way - 2 module	1370	10/100
5725 44	Switch - 20 A-3 gang - 2x2 way + 1x1 way - 2 module	1430	10/100
5736 54	Switch 20 A-DP - 1 way with indicator - 2 module	1106	10/100
5725 49	Switch - 20 A-DP - 1 way with indicator and water heater marking - 2 module	1182	10/100

Switches - 25 A - 230 V AC

5736 17	25A switch with indicator	634	20/200
---------	---------------------------	-----	--------



5734 61



5722 44



5721 53



5722 55



5722 72



5734 80



5734 49

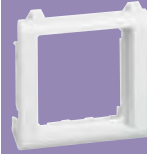

5760 16



5736 00



5736 03

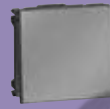

5736 50



5736 11

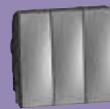

5725 44



5725 49

Arteor™

square - magnesium mechanisms

Cat.Nos	Description	MRP* ₹ / Unit	Pack
---------	-------------	------------------	------

Switches – 32 A / 40 A - 250 V AC

5736 12	Switch - 32 A-DP - 1 way with indicator - 2 module	1544	10/100
---------	--	------	--------

square - magnesium mechanisms

Push button – 6 A - 250 V AC

5736 13	Bell push - 6 A-SP- 1 way - 1 module	384	20/200
5736 59	Bell push - 6 A-SP - 1 way - 2 module	550	10/100
5736 04	Push button - 6 A-SP - 1 way -1 module	398	20/200
5736 05	Push button - 6 A-SP - 1 way with indicator - 1 module	532	20/200
5736 14	Bell push - 6 A-SP - 1 way with indicator - 1 module	528	20/200
5736 60	Bell push - 6 A-SP - 1 way with indicator - 2 module	738	10/100

Electric roller blinds control

5727 20	Double switch for electric shutter - 2 module	966	10/100
---------	---	-----	--------

Dimmers and fan regulators

5736 62	Light dimmer - 60 to 400 watts - 2 module	1552	10/100
5736 16	Fan step regulator - 100 watts (ISI) - 1 module	1276	1/5/50
5736 63	Fan step regulator - 100 watts (ISI) - 2 module	1572	1/10/100
5736 69	Fan step regulator - 120 watts (ISI) - 2 module (for 48 & 56" fans)	1682	1/10/100
5736 68	Fan step regulator - 2 module for energy saving fan	1668	1/10/100
5736 56	Fan regulator - 8 Step - 100W - 2 module	1492	1/10/100

Electronic dimmer

5727 39	Universal dimmer without neutral 400 W - 2 module	13336	1/10
---------	---	-------	------

Indian standard sockets

5736 71	Socket shuttered - 6/16 A - 3 pin - (ISI) - Indian - 2 module	644	10/100
5736 67	Socket shuttered - 6/16 A - 3 pin - (ISI) - Indian - 3 module	786	5/50
5737 10	Socket with switch - 16 A - 3 pin - 2P+E - Indian 3 module	1822	5/50
5736 66	25 A socket - 2 module	784	10/100

* MRP - Maximum Retail Price Inclusive of all taxes including GST.
 ■ Price available on request

Arteor™

square - magnesium mechanisms

Cat.Nos	Description	MRP* ₹ / Unit	Pack
---------	-------------	------------------	------

Indian standard sockets

5736 24	Socket - 6A - ISI - 3 pin - 2 module	326	1/20/200
----------------	--------------------------------------	-----	----------

USB chargers (IS13252 (Part 1) / IEC 60950-1)

5734 44	USB charger 1M Type A 1500 mA	2516	1/5/50
5736 36	USB Charger 1M Type C 1500 mA	2550	1/5/50
5736 22	Double USB charger 2M 2400mA	3478	1/10/100

Combi (Socket + USB)

5736 18	Combi twin USB CHARGER 3.1A Type A & A with Euro Socket - 2 Module	2572	1/10/100
5736 19	Combi twin USB charger 3.1A type A & C with Euro Socket - 2 module	3002	1/10/100
5736 20	Combi twin USB charger 3.1A type C & C with Euro Socket - 2 module	3900	1/10/100
5736 07	Combi twin USB CHARGER 3.1A Type A & C with Multistandard Socket - 3 module Gang Unit-6 A	4180	1/5/20
5736 08	Multistandard Switched socket with USB 3100mA type A-2 Module Gang Unit-6 A	3858	1/10
5736 09	Multistandard Switched socket with USB 3100mA type A + C-4 module	5248	1/5/20

RJ 11 telephone sockets (Jack type)

5736 27	Telephone socket - double RJ11 - 1 module	576	20/200
5736 26	Telephone socket - RJ11 with shutter - 1 module	348	20/200

Information outlets - toolless

5736 29	Information socket - category 5e - UTP - 1 module	724	20/200
5736 75	Information socket - category 5e - UTP - 2 module	736	10/100
5736 28	Information socket - category 6 - UTP - 1 module	1106	20/200

Bold Cat.Nos are products normally available with Legrand (India) Stockists. Cat.Nos that are not bold - delivery within 4 - 8 weeks from the date of order. Bold packing quantity is our mandatory packing. Orders to be placed by Legrand (India) Stockist in multiples of the same.



5736 59



5736 14



5727 20



5736 16



5727 39



5736 71



5736 22

NEW!

NEW!

NEW!

NEW!



5736 27



5736 28

Arteor™ square - magnesium mechanisms

Cat.Nos	Description	MRP* ₹ / Unit	Pack
---------	-------------	------------------	------

Information outlets - toolless

5736 74	Information socket - category 6 - UTP - 2 module	1164	10/100
---------	--	------	--------

TV sockets

5736 25	TV Co-Axial socket - 1 module	358	20/200
---------	-------------------------------	-----	--------

Electronic chime

5736 43	Bell ding dong 230 V - 2 module	492	10/100
---------	---------------------------------	-----	--------

Buzzer

5736 42	Buzzer- 230 V - 1 module	1792	20/200
---------	--------------------------	------	--------

Bell call indicator & registor - 6A - 250V AC

5736 15	Bell call indicator with registor - 6 A - 1 way - SP - 1 module	2358	20/200
---------	---	------	--------

Lighting

5735 64	Skirting light with LED - 230 V - 3 module	1268	1/5/25
5727 26	Skirting light with detector (LED) - 230 V - 2 module	19276	1/20

Hotel "DND and MMR " functions

5736 61	DND and MMR indicator with bell push 1+1 module	2520	5/50
5736 58	Internal control unit for DND & MMR 1+1 module	1822	10/100

Hotel keycard switch

5727 44	16 A Key card switch 230 V with time delay - 2 module	6610	1/20
5727 59	Key fob for above	2272	10/50

Shaver socket

5726 53	Shaver socket 230 V / 120-230 V with earth connector	6872	1
---------	--	------	---

Time switch

5740 84	Time delay switch - 2 module	8606	1/20
---------	------------------------------	------	------

Audio-video sockets

5727 72	Double RCA socket (audio) - 1 module	5800	1/20
5727 73	Triple RCA socket (audio & video) - 1 module	4524	1/20
5727 74	Female 3.5 mm Jack - 1 module	5146	1/20

Arteor™ square - magnesium mechanisms

Cat.Nos	Description	MRP* ₹ / Unit	Pack
---------	-------------	------------------	------

Audio-video sockets

5727 76	Female BNC 75 jack - 1 module	5006	1/20
5727 83	Female XLR jack - 2 module	9002	1/20
5725 97	Preterminated sockets Female HD15 - 1 module	7098	1

Audio-video sockets

5725 96	Preterminated sockets HDMI 1.4 - 1 module	8046	1
5727 84	Line dying down 100 V (25-30 W) 2 module	14408	1
5727 75	USB socket - 1 module	4022	1/20
5727 88	Female HD15 + Jack 3.5 mm - 2 module	5648	1/20

Blanking plate

5736 49	1 module blank	58	20/200
5728 44	2 modules blank	96	10/100

Dedicated switches

5738 02	Dedicated switch - 20 A - 1 way - DP - red - 1 module	1112	5/40
---------	---	------	------

Tamper proof and dedicated sockets

5738 10	Dedicated socket with switch - 16 A - 3 pin - 2P+E - Indian - 3 module	2234	5/50
---------	--	------	------

Square - Champagne mechanisms

Switches – 6 A - 250 V AC

5748 00	Switch - 6 A-SP - 1 way - 1 module	244	20/200
5748 01	Switch - 6 A-SP - 1 way with indicator - 1 module	414	20/200
5748 02	Switch - 6 A-SP - 2 way - 1 module	370	20/200
5748 03	Switch - 6 A-SP - 2 way with indicator - 1 module	528	20/200

Switches – 10 A - 250 V AC

5748 04	Switch - 10 A-SP - 1 way - 2 module	396	10/100
5748 05	Switch - 10 A-SP - 2 way - 2 module	468	10/100
5748 06	Switch - 10 A-SP - 2 way with indicator & label holder- 2 module	2340	10/100
5748 07	Intermediate switch - 2 module	2862	10/100

* MRP - Maximum Retail Price Inclusive of all taxes including GST.
 * To be Introduced Shortly
 (1) Supplied with white plate
 ■ Price available on request

Bold Cat.Nos are products normally available with Legrand (India) Stockists. Cat.Nos that are not bold - delivery within 4 - 8 weeks from the date of order. Bold packing quantity is our mandatory packing. Orders to be placed by Legrand (India) Stockist in multiples of the same.

Arteor™ square - champagne mechanisms

Cat.Nos	Description	MRP* ₹ / Unit	Pack
---------	-------------	------------------	------

Switches – 20 A - 250 V AC

5748 08	Switch - 20 A-SP - 1 way 1 module	480	20/200
5748 09	Switch - 20 A-SP - 1 way 2 module	564	10/100
5748 10	Switch - 20 A-SP - 1 way with indicator - 1 module	504	20/200
5748 11	Switch - 20 A-SP - 2 way with indicator - 1 module	690	20/200
5748 12	Switch - 20 A-SP - 2 way with indicator - 2 module	740	10/100
5748 13	Switch - 20 A-3 gang - 1 way - 2 module	1368	10/100
5748 14	Switch - 20 A-3 gang - 2x2 way + 1x1 way - 2 module	1430	10/100
5748 15	Switch 20 A-DP - 1 way with indicator - 2 module	1106	10/100
5748 16	Switch - 20 A-DP - 1 way with indicator and water heater marking - 2 module	1182	10/100

Switches – 25 A - 230 V AC

5748 17	25A switch with indicator	634	20/200
---------	---------------------------	-----	--------

Switches – 32 A / 40 A - 250 V AC

5748 18	Switch - 32 A-DP - 1 way with indicator - 2 module	1544	10/100
5748 19	Switch - 40 A-DP - 1 way with indicator - fits on 1/2 module box	1776	1/5/20

Push button – 6 A - 250 V AC

5748 23	Bell push - 6 A-SP - 1 way - 1 module	384	20/200
5748 24	Bell push - 6 A-SP - 1 way - 2 module	550	10/100
5748 21	Push button - 6 A-SP - 1 way - 1 module	398	20/200
5748 22	Push button - 6 A-SP - 1 way with indicator - 1 module	532	20/200
5748 25	Bell push - 6 A-SP - 1 way with indicator - 1 module	528	20/200
5748 26	Bell push - 6 A-SP - 1 way with indicator - 2 module	738	10/100

Electric roller blinds control

5748 20	Double switch for electric shutter - 2 module	966	10/100
---------	---	-----	--------

Dimmers and fan regulators

5748 27	Light dimmer - 60 to 400 watts - 2 module	1596	10/100
5748 29	Fan step regulator - 100 watts (ISI) - 1 module	1276	1/5/50
5748 30	Fan step regulator - 100 watts (ISI) - 2 module	1572	1/10/100
5748 31	Fan step regulator - 120 watts (ISI) - 2 module (for 48 & 56" fans)	1682	1/10/100
5748 32	Fan step regulator - 2 module for energy saving fan	1668	1/10/100
5736 57	Fan Regulator - 8 Step - 100W - 2 Module	1492	1/10/100

* MRP - Maximum Retail Price Inclusive of all taxes including GST.
Red Cat.Nos - new products
■ Price available on request.

Arteor™ square - champagne mechanisms

Cat.Nos	Description	MRP* ₹ / Unit	Pack
---------	-------------	------------------	------

Indian standard sockets

5748 34	Socket shuttered - 6/16 A - 3 pin-(ISI) Indian - 2 module	644	10/100
5748 35	Socket shuttered - ISI 6/16 A - 3 pin - Indian - 3 module	786	5/50
5748 41	25 A socket - 2 module	784	10/100
5748 84	Socket - 6A - ISI - 3 pin - 2 module	326	1/20/200

USB chargers (IS13252 (Part 1) / IEC 60950-1)

5734 47	USB Charger 1500mA Type A, 1 module	2516	1/5/50
5748 66	USB Charger 1500mA Type C, 1 module	2550	1/5/50
5748 44	Double USB Charger 2400mA Type A, 2 module	3478	1/10/100

Combi (Socket + USB)

5748 78	Combi twin USB charger 3.1A type A & A with Euro Socket - 2 module	2572	1/10/100
5748 79	Combi twin USB charger 3.1A type A & C with Euro Socket - 2 module	3002	1/10/100
5748 80	Combi twin USB charger 3.1A type C & C with Euro Socket - 2 module	3900	1/10/100
5748 67	Combi twin USB Charger 3.1A Type A & C with Multistandard Socket - 3 Module	4180	1/5/20
5748 68	Gang Unit-6A Multistandard Switched socket with USB 3100mA type A-2 module	3958	1/10
5748 69	Gang Unit-6A Multistandard Switched socket with USB 3100mA Type A + C-4 module	5418	1/5/20

RJ 11 telephone sockets (Jack type)

5748 45	Telephone socket - double RJ11 - 1 module	576	20/200
5748 46	Telephone socket - RJ11 with shutter - 1 module	348	20/200

Information outlets - toolless

5748 47	Information socket - category 5e - UTP - 1 module	724	20/200
5748 48	Information socket - category 5e - UTP - 2 module	778	10/100
5748 49	Information socket - category 6 - UTP - 1 module	1106	20/200
5748 50	Information socket - category 6 - UTP - 2 module	1164	10/100

Bold Cat.Nos are products normally available with Legrand (India) Stockists. Cat.Nos that are not bold - delivery within 4 - 8 weeks from the date of order. Bold packing quantity is our mandatory packing. Orders to be placed by Legrand (India) Stockist in multiples of the same.

Arteor™ square - champagne mechanisms

Cat.Nos	Description	MRP* ₹ / Unit	Pack
---------	-------------	------------------	------

TV sockets

5748 51	TV Co-Axial socket - 1 module	358	20/200
---------	-------------------------------	-----	--------

Electronic chime

5748 52	Bell ding dong 230 V - 2 module	492	10/100
---------	---------------------------------	-----	--------

Buzzer

5748 53	Buzzer- 230 V - 1 module	1792	20/200
---------	--------------------------	------	--------

Bell call indicator & register - 6A - 250V AC

5748 54	Bell call indicator with register - 6 A - 1 way - SP - 1 module	2358	20/200
---------	---	------	--------

Lighting

5748 55	Skirting light with LED - 230 V - 3 module	1268	1/5/25
---------	--	------	--------

Hotel "DND and MMR" functions

5748 56	DND and MMR indicator with bell push 1+1 module	2520	5/50
5748 57	Internal control unit for DND & MMR 1+1 module	1822	10/100

Hotel keycard switch

5748 58	16 A Key card switch 230 V with time delay - 2 module	6516	1/20
5727 59	Key fob for above	2272	10/50

Blanking plate

5748 63	1 module blank	58	20/200
5748 64	2 modules blank	96	10/100

Round - white mechanisms

Switches - 6 A - 250 V AC

5733 00	Switch - 6 A-SP - 1 way left - 1 module	314	20/200
5733 01	Switch - 6 A-SP - 1 way right - 1 module	314	20/200
5733 12	Switch - 6 A-SP - 1 way middle - 1 module	314	20/200
5733 05	Switch - 6 A-SP - 2 way - left - 1 module	382	20/200
5733 06	Switch - 6 A-SP - 2 way - right - 1 module	382	20/200
5733 02	Switch - 6 A-SP - 1 way with indicator - left - 1 module	436	20/200
5733 04	Switch - 6 A-SP - 1 way with indicator - right - 1 module	436	20/200
5733 03	Switch - 6 A-SP - 1 way with indicator - middle - 1 module	436	20/200
5733 07	Switch - 6 A-SP - 2 way with indicator - left - 1 module	548	20/200
5733 08	Switch - 6 A-SP - 2 way with indicator - right - 1 module	548	20/200

Arteor™ round - white mechanisms

Cat.Nos	Description	MRP* ₹ / Unit	Pack
---------	-------------	------------------	------

Switches - 20 A - 250 V AC

5733 20	Switch - 20 A-SP - 1 way - left - 1 module	510	20/200
5733 21	Switch - 20 A-SP - 1 way - right - 1 module	510	20/200
5730 21	Switch - 20 A-SP - 1 way - middle - 1 module	520	20/200
5733 40	Switch - 20 A-SP - 1 way - 2 module	594	10/100
5720 64	Switch - 20 A-SP - 1 way with indicator-left - 1 module	526	20/200
5720 65	Switch - 20 A-SP - 1 way with indicator-right - 1 module	526	20/200
5730 24	Switch - 20 A-SP - 2 way - middle - 1 module	528	20/200
5733 22	Switch - 20 A-SP - 2 way with indicator-left - 1 module	730	20/200
5733 23	Switch - 20 A-SP - 2 way with indicator-right - 1 module	730	20/200
5730 71	Switch - 20 A-SP - 2 way with indicator - 2 module	648	10/100
5730 72	Switch - 20 A-3 gang - 1 way - 2 module	1428	10/100
5730 73	Switch - 20 A-3 gang - 2x2 way+1x1 way - 2 module	1572	10/100
5733 42	Switch 20 A-DP - 1 way with indicator - 2 module	1106	10/100

Switches - 32 A

5733 26	Switch - 32 A-DP - 1 way with indicator - 2 module	1612	10/100
---------	--	------	--------

Push button - 6 A - 250 V AC

5733 31	Bell push - 6 A-SP - 1 way - right - 1 module	398	20/200
5733 30	Bell push - 6 A-SP - 1 way - left - 1 module	398	20/200
5733 46	Bell push - 6 A-SP - 1 way - 2 module	566	10/100
5733 47	Bell push - 6 A-SP - 1 way with indicator - 2 module	770	10/100

Electric roller blinds control

5732 20	Double switch for electric shutter - 2 module	1008	10/100
---------	---	------	--------

Dimmers and fan regulators

5730 66	Light dimmer - 60 to 400 Watts - 2 module	1616	1/10/100
5730 03	Fan step regulator - 100 Watts (ISI) - 2 module	1640	1/10/100
5730 69	Fan step regulator - 120 Watts (ISI) - 2 module	1778	1/10/100
5730 04	Fan step regulator - 2 module for energy saving fans	1740	1/10/100

* MRP - Maximum Retail Price Inclusive of all taxes including GST.
 * To be Introduced Shortly
 Red Cat.Nos - new products
 (1) Supplied with white plate
 ■ Price available on request

Bold Cat.Nos are products normally available with Legrand (India) Stockists.
 Cat.Nos that are not bold - delivery within 4 - 8 weeks from the date of order.
 Bold packing quantity is our mandatory packing. Orders to be placed by Legrand (India) Stockist in multiples of the same.

Arteor™

round - white mechanisms

Cat.Nos	Description	MRP* ₹ / Unit	Pack
---------	-------------	------------------	------

Electronic dimmer

5743 19	Universal dimmer without neutral 400 W - 2 module	13652	1/10
---------	---	-------	------

USB chargers (IS13252 (Part 1) / IEC 60950-1)

5734 23	Double USB charger 2M 2400mA	3346	1/10/100
---------	------------------------------	------	----------

Information outlets - toolless

5723 24	Information socket - category 6-UTP- 2 module	1294	10/100
---------	---	------	--------

Hotel internal control units

5720 74	Internal control unit for DND & MMR - 1+1 module	2206	5/50
5720 67	DND & MMR indicator with bell push - 2 module	2772	5/40

Blanking plate

5730 87	2 modules blank	98	10/100
---------	-----------------	----	--------

Round - magnesium mechanisms

Switches - 6 A - 250 V AC

5733 50	Switch - 6 A-SP - 1 way - left - 1 module	360	20/200
5733 51	Switch - 6 A-SP - 1 way - right - 1 module	360	20/200
5733 62	Switch - 6 A-SP - 1 way - middle - 1 module	362	20/200
5733 55	Switch - 6 A-SP - 2 way - left - 1 module	442	20/200
5733 56	Switch - 6 A-SP - 2 way - right - 1 module	442	20/200
5733 52	Switch - 6 A-SP - 1 way with indicator - left - 1 module	490	20/200

Switches - 6 A - 250 V AC

5733 54	Switch - 6 A-SP - 1 way with indicator - right - 1 module	490	20/200
5733 57	Switch - 6 A-SP - 2 way with indicator - left - 1 module	634	20/200
5733 58	Switch - 6 A-SP - 2 way with indicator - right - 1 module	634	20/200

Switches - 20 A - 250 V AC

5733 70	Switch - 20 A-SP - 1 way - left - 1 module	568	20/200
5733 71	Switch - 20 A-SP - 1 way - right - 1 module	568	20/200
5731 21	Switch - 20 A-SP - 1 way - middle - 1 module	568	20/200
5733 90	Switch - 20 A-SP - 1 way - 2 module	674	10/100
5725 64	Switch - 20 A-SP - 1 way with indicator - left - 1 module	594	20/200
5725 65	Switch - 20 A-SP - 1 way with indicator - right - 1 module	594	20/200

* MRP - Maximum Retail Price Inclusive of all taxes including GST.
 ■ Price available on request.

Arteor™

round - magnesium mechanisms

Cat.Nos	Description	MRP* ₹ / Unit	Pack
---------	-------------	------------------	------

Switches - 20 A - 250 V AC

5731 24	Switch - 20 A-SP - 2 way - middle - 1 module	604	20/200
5733 72	Switch - 20 A-SP - 2 way with indicator - left - 1 module	828	20/200
5733 73	Switch - 20 A-SP - 2 way with indicator - right - 1 module	828	20/200
5731 71	Switch - 20 A-SP - 2 way with indicator - 2 module	786	10/100
5731 72	Switch - 20 A-3 gang - 1 way - 2 module	1638	10/100
5731 73	Switch - 20 A-3 gang - 2x2 way + 1x1 way - 2 module	1728	10/100
5733 92	Switch 20 A-DP - 1 way with indicator - 2 module	1280	10/100
5731 27	Switch - 20 A-SP - 2 way with indicator - middle - 1 module	830	20/200

Switches - 32A

5733 76	Switch - 32 A-DP - 1 way with indicator - 2 module	1846	10/100
---------	--	------	--------

Push button - 6 A - 250 V AC

5733 81	Bell push - 6 A-SP - 1 way - right - 1 module	468	20/200
5733 80	Bell push - 6 A-SP - 1 way - left - 1 module	468	20/200
5733 96	Bell push - 6 A-SP - 1 way - 2 module	664	10/100
5733 97	Bell push - 6 A-SP - 1 way with indicator - 2 module	872	10/100

Electronic roller blinds control

5737 20	Double switch for electric shutter - 2 module	1168	10/100
---------	---	------	--------

Dimmers and fan regulators

5733 66	Light dimmer - 60 to 400 watts - 2 module	1876	1/10/100
5731 03	Fan step regulator - 100 watts (ISI) - 2 module	1888	1/10/100
5731 69	Fan step regulator - 120 watts (ISI) - 2 module	2032	1/10/100
5731 04	Fan step regulator - 2 module for energy saving fans	2010	1/10/100

Electronic dimmer

5743 39	Universal dimmer without neutral 400 W - 2 module	16744	1/10
---------	---	-------	------

USB chargers (IS13252 (Part 1) / IEC 60950-1)

5736 23	Double USB charger 2M 2400mA	3832	1/10/100
---------	------------------------------	------	----------

Information outlets - toolless

5728 24	Information socket - category 6 - UTP - 2 module	1480	10/100
---------	--	------	--------

Hotel internal control units

5725 74	Internal control unit for DND & MMR - 1+1 module	2530	5/50
---------	--	------	------

Bold Cat.Nos are products normally available with Legrand (India) Stockists. Cat.Nos that are not bold - delivery within 4 - 8 weeks from the date of order. Bold packing quantity is our mandatory packing. Orders to be placed by Legrand (India) Stockist in multiples of the same.

Arteor™

round - magnesium mechanisms

Cat.Nos	Description	MRP* ₹ / Unit	Pack
---------	-------------	------------------	------

Hotel internal control units

5725 67	DND & MMR Indicator with bell push - 2 module	3026	5/40
---------	---	------	------

Blanking plate

5731 87	2 modules blank	114	10/100
---------	-----------------	-----	--------

Round - champagne mechanisms

Switches - 6 A - 250 V AC

5749 00	Switch - 6 A-SP - 1 way - left - 1 module	360	20/200
5749 01	Switch - 6 A-SP - 1 way - right - 1 module	360	20/200
5749 02	Switch - 6 A-SP - 1 way - middle - 1 module	360	20/200
5749 03	Switch - 6 A-SP - 2 way - left - 1 module	442	20/200
5749 04	Switch - 6 A-SP - 2 way - right - 1 module	442	20/200
5749 05	Switch - 6 A-SP - 1 way with indicator - left - 1 module	490	20/200
5749 06	Switch - 6 A-SP - 1 way with indicator - right - 1 module	490	20/200
5749 07	Switch - 6 A-SP - 1 way with indicator - middle - 1 module	490	20/200
5749 08	Switch - 6 A-SP - 2 way with indicator - left - 1 module	634	20/200
5749 09	Switch - 6 A-SP - 2 way with indicator - right - 1 module	634	20/200

Switches - 20 A - 250 V AC

5749 10	Switch - 20 A-SP - 1 way - left - 1 module	568	20/200
5749 11	Switch - 20 A-SP - 1 way - right - 1 module	568	20/200
5749 12	Switch - 20 A-SP - 1 way - middle - 1 module	568	20/200
5749 13	Switch - 20 A-SP - 1 way - 2 module	674	10/100
5749 14	Switch - 20 A-SP - 1 way with indicator - left - 1 module	594	20/200
5749 15	Switch - 20 A-SP - 1 way with indicator - right - 1 module	594	20/200
5749 16	Switch - 20 A-SP - 2 way - middle - 1 module	602	20/200
5749 17	Switch - 20 A-SP - 2 way with indicator - left - 1 module	830	20/200
5749 18	Switch - 20 A-SP - 2 way with indicator - right - 1 module	830	20/200
5749 19	Switch - 20 A-SP - 2 way with indicator - 2 module	786	10/100
5749 20	Switch - 20 A-3 gang - 1 way - 2 module	1638	10/100
5749 21	Switch - 20 A-3 gang - 2x2 way + 1x1 way - 2 module	1728	10/100
5749 22	Switch 20 A-DP - 1 way with indicator - 2 module	1280	10/100

Arteor™

round - champagne mechanisms

Cat.Nos	Description	MRP* ₹ / Unit	Pack
---------	-------------	------------------	------

Push button - 6 A - 250 V AC

5749 23	Bell push - 6 A-SP - 1 way - right - 1 module	468	20/200
5749 24	Bell push - 6 A-SP - 1 way - left - 1 module	468	20/200
5749 25	Bell push - 6 A-SP - 1 way - 2 module	664	10/100
5749 26	Bell push - 6 A-SP - 1 way with indicator - 2 module	872	10/100

Dimmers and fan regulators

5749 27	Light dimmer - 60 to 400 watts - 2 module	1934	1/10/100
5749 29	Fan step regulator - 100 watts (ISI) - 2 module	1888	1/10/100
5749 30	Fan step regulator - 120 watts (ISI) - 2 module	2032	1/10/100
5749 31	Fan step regulator - 2 module for energy saving fans	2010	1/10/100

USB chargers (IS13252 (Part 1) / IEC 60950-1)

5749 44	Double USB charger 2M 2400mA	3832	1/10/100
---------	------------------------------	------	----------

Blanking plate

5749 64	2 modules blank	114	10/100
---------	-----------------	-----	--------

Square cover plates with Metal Frame White cover plates with Metal frame

5757 00	White plate - 1 module	248	10/100
5757 10	White plate - 2 module	262	10/100
5757 20	White plate - 3 module	292	10/100
5757 30	White plate - 4 module	306	5/50
5757 40	White plate - 6 module	562	5/30
5757 50	White plate - 8 module	624	5/30
5757 60	White plate - 2x4 module	786	2/20
5757 70	White plate - 2x6 module	962	2/16
5757 80	White plate - 2x8 module	1154	2/16
5757 90	White plate - 3x6 module	1276	2/12
5758 00	White plate - 3x8 module	1526	2/12
5750 70	White plate for shaver socket 3 module	438	5/50

Pearl Aluminium cover plates with Metal frame

5759 73	Pearl Aluminium plate - 1 module	372	10/100
5759 74	Pearl Aluminium plate - 2 module	386	10/100
5759 75	Pearl Aluminium plate - 3 module	418	10/100
5759 76	Pearl Aluminium plate - 4 module	472	5/50
5759 77	Pearl Aluminium plate - 6 module	812	5/30
5759 78	Pearl Aluminium plate - 8 module	892	5/30
5759 79	Pearl Aluminium plate - 2x4 module	1134	2/20

* MRP - Maximum Retail Price Inclusive of all taxes including GST.
Red Cat.Nos - new products
■ Price available on request.

Bold Cat.Nos are products normally available with Legrand (India) Stockists. Cat.Nos that are not bold - delivery within 4 - 8 weeks from the date of order. Bold packing quantity is our mandatory packing. Orders to be placed by Legrand (India) Stockist in multiples of the same.

Arteor™

square cover plates with metal frame

Cat.Nos	Description	MRP* ₹ / Unit	Pack
---------	-------------	------------------	------

Pearl Aluminium cover plates with Metal frame

5759 80	Pearl Aluminium plate - 2x6 module	1474	2/16
5759 81	Pearl Aluminium plate - 2x8 module	1668	2/16
5759 82	Pearl Aluminium plate - 3x6 module	1950	2/12
5759 83	Pearl Aluminium plate - 3x8 module	2220	2/12

Graphite cover plates with Metal frame

5759 61	Graphite plate - 1 module	372	10/100
5759 62	Graphite plate - 2 module	386	10/100
5759 63	Graphite plate - 3 module	418	10/100
5759 64	Graphite plate - 4 module	472	5/50
5759 66	Graphite plate - 6 module	812	5/30
5759 67	Graphite plate - 8 module	892	5/30
5759 68	Graphite plate - 2x4 module	1134	2/20
5759 69	Graphite plate - 2x6 module	1474	2/16
5759 70	Graphite plate - 2x8 module	1668	2/16
5759 71	Graphite plate - 3x6 module	1950	2/12
5759 72	Graphite plate - 3x8 module	2220	2/12

Magnesium cover plates with Metal frame

5755 89	Magnesium plate - 1 module	372	10/100
5755 90	Magnesium plate - 2 module	386	10/100
5755 91	Magnesium plate - 3 module	418	10/100
5755 93	Magnesium plate - 4 module	472	5/50
5755 94	Magnesium plate - 6 module	812	5/30
5755 95	Magnesium plate - 8 module	892	5/30
5755 96	Magnesium plate - 2x4 module	1134	2/20
5755 97	Magnesium plate - 2x6 module	1474	2/16
5755 98	Magnesium plate - 2x8 module	1668	2/16
5755 99	Magnesium plate - 3x6 module	1950	2/12

Champagne cover plates with Metal frame

5759 84	Champagne plate - 1 module	372	10/100
5759 85	Champagne plate - 2 module	386	10/100
5759 86	Champagne plate - 3 module	418	10/100
5759 87	Champagne plate - 4 module	472	5/50
5759 88	Champagne plate - 6 module	812	5/30
5759 89	Champagne plate - 8 module	892	5/30
5759 90	Champagne plate - 2x4 module	1134	2/20
5759 91	Champagne plate - 2x6 module	1474	2/16
5759 92	Champagne plate - 2x8 module	1668	2/16
5759 93	Champagne plate - 3x6 module	1950	2/12

Dark Bronze cover plates with Metal frame

5756 79	Dark Bronze plate - 1 module	372	10/100
5756 80	Dark Bronze plate - 2 module	386	10/100
5756 81	Dark Bronze plate - 3 module	418	10/100
5756 83	Dark Bronze plate - 4 module	472	5/50
5756 84	Dark Bronze plate - 6 module	812	5/30
5756 85	Dark Bronze plate - 8 module	892	5/30
5756 86	Dark Bronze plate - 2x4 module	1134	2/20
5756 87	Dark Bronze plate - 2x6 module	1474	2/16
575688	Dark Bronze plate - 2x8 module	1668	2/16



5757 21



5757 61



5757 22



5757 42



5758 13



5758 17

Arteor™

square cover plates with metal frame

Cat.Nos	Description	MRP* ₹ / Unit	Pack
---------	-------------	------------------	------

Dark Bronze cover plates with Metal frame

5756 89	Dark Bronze plate - 3x6 module	1950	2/12
---------	--------------------------------	------	------

Pearl aluminium cover plates with Overmoulded frame

5757 01	Pearl aluminium plate - 1 module	412	10/100
5757 11	Pearl aluminium plate - 2 module	436	10/100
5757 21	Pearl aluminium plate - 3 module	464	10/100
5757 31	Pearl aluminium plate - 4 module	524	5/50
5757 41	Pearl aluminium plate - 6 module	894	5/30
5757 51	Pearl aluminium plate - 8 module	992	5/30
5757 61	Pearl aluminium plate - 2x4 module	1258	2/20
5757 71	Pearl aluminium plate - 2x6 module	1636	2/16
5757 81	Pearl aluminium plate - 2x8 module	1856	2/16
5757 91	Pearl aluminium plate - 3x6 module	2170	2/12
5758 01	Pearl aluminium plate - 3x8 module	2464	2/12
5750 71	Pearl aluminium plate for shaver socket 3 module	702	5/50

Graphite cover plates with Overmoulded frame

5757 02	Graphite plate - 1 module	412	10/100
5757 12	Graphite plate - 2 module	436	10/100
5757 22	Graphite plate - 3 module	464	10/100
5757 32	Graphite plate - 4 module	524	5/50
5757 42	Graphite plate - 6 module	894	5/30
5757 52	Graphite plate - 8 module	992	5/30
5757 62	Graphite plate - 2x4 module	1258	2/20
5757 72	Graphite plate - 2x6 module	1636	2/16
5757 82	Graphite plate - 2x8 module	1856	2/16
5757 92	Graphite plate - 3x6 module	2170	2/12
5758 02	Graphite plate - 3x8 module	2466	2/12
5750 72	Graphite plate for shaver socket 3 module	702	5/50

Magnesium cover plates with Overmoulded frame

5758 11	Magnesium plate - 1 module	412	10/100
5758 12	Magnesium plate - 2 module	436	10/100
5758 13	Magnesium plate - 3 module	464	10/100
5758 14	Magnesium plate - 4 module	524	5/50
5758 15	Magnesium plate - 6 module	894	5/30
5758 16	Magnesium plate - 8 module	992	5/30
5758 17	Magnesium plate - 2x4 module	1258	2/20
5758 18	Magnesium plate - 2x6 module	1636	2/16
5758 19	Magnesium plate - 2x8 module	1856	2/16
5758 20	Magnesium plate - 3x6 module	2170	2/12
5758 21	Magnesium plate for shaver socket 3 module	704	5/50

* MRP - Maximum Retail Price Inclusive of all taxes including GST.
Red Cat.Nos - new products

Bold Cat.Nos are products normally available with Legrand (India) Stockists.
Cat.Nos that are not bold - delivery within 4 - 8 weeks from the date of order.
Bold packing quantity is our mandatory packing. Orders to be placed by Legrand (India) Stockist in multiples of the same.

Arteor™ square cover plates

Cat.Nos	Description	MRP* ₹ / Unit	Pack
---------	-------------	------------------	------

Champagne cover plates with Overmoulded frame

5758 22	Champagne plate - 1 module	412	10/100
5758 23	Champagne plate - 2 module	436	10/100
5758 24	Champagne plate - 3 module	464	10/100
5758 25	Champagne plate - 4 module	524	5/50
5758 26	Champagne plate - 6 module	894	5/30
5758 27	Champagne plate - 8 module	992	5/30
5758 28	Champagne plate - 2x4 module	1258	2/20
5758 29	Champagne plate - 2x6 module	1636	2/16
5758 30	Champagne plate - 2x8 module	1856	2/16
5758 31	Champagne plate - 3x6 module	2170	2/12
5758 32	Champagne plate for shaver socket 3 module	704	5/50

Dark Bronze cover plates with Overmoulded frame

5758 33	Dark Bronze plate - 1 module	412	10/100
5758 34	Dark Bronze plate - 2 module	436	10/100
5758 35	Dark Bronze plate - 3 module	464	10/100
5758 36	Dark Bronze plate - 4 module	524	5/50
5758 37	Dark Bronze plate - 6 module	894	5/30
5758 38	Dark Bronze plate - 8 module	992	5/30
5758 39	Dark Bronze plate - 2x4 module	1258	2/20
5758 40	Dark Bronze plate - 2x6 module	1636	2/16
5758 41	Dark Bronze plate - 2x8 module	1856	2/16
5758 42	Dark Bronze plate - 3x6 module	2170	2/12
5758 43	Dark Bronze plate for shaver socket 3 module	704	5/50

Mirror finish cover plates with Overmoulded frame

5757 03	Mirror black plate - 1 module	2048	1/5/30
5757 13	Mirror black plate - 2 module	2188	1/5/30
5757 23	Mirror black plate - 3 module	2344	1/20
5757 33	Mirror black plate - 4 module	2492	1/20
5757 43	Mirror black plate - 6 module	4534	1/5
5757 53	Mirror black plate - 8 module	4994	1/5
5757 63	Mirror black plate - 2x4 module	6328	1/10
5757 73	Mirror black plate - 2x6 module	7786	1/8
5757 04	Mirror white plate - 1 module	2048	1/5/30
5757 14	Mirror white plate - 2 module	2188	1/5/30
5757 24	Mirror white plate - 3 module	2344	1/20
5757 34	Mirror white plate - 4 module	2492	1/20
5757 44	Mirror white plate - 6 module	4534	1/5
5757 54	Mirror white plate - 8 module	4994	1/5
5757 64	Mirror white plate - 2x4 module	6446	1/10
5757 74	Mirror white plate - 2x6 module	7786	1/8
5758 44	Green Apple plate - 1 module	2048	1/5/30
5758 45	Green Apple plate - 2 module	2188	1/5/30
5758 46	Green Apple plate - 3 module	2344	1/20
5758 47	Green Apple plate - 4 module	2492	1/20
5758 48	Green Apple plate - 6 module	4534	1/5
5758 49	Green Apple plate - 8 module	4994	1/5
5758 50	Green Apple plate - 2x4 module	6444	1/10
5758 51	Green Apple plate - 2x6 module	7786	1/8
5758 52	Green Apple plate for shaver socket 3 module	3414	1/5/50

Graphic cover plates with Overmoulded frame

5762 91	Graphic casual plate - 1 module	2486	1/5/30
5763 11	Graphic casual plate - 2 module	2674	1/5/30
5763 31	Graphic casual plate - 3 module	2874	1/5/20

Arteor™ square cover plates

Cat.Nos	Description	MRP* ₹ / Unit	Pack
---------	-------------	------------------	------

Graphic cover plates with Overmoulded frame

5763 51	Graphic casual plate - 4 module	3066	1/20
5763 81	Graphic casual plate - 6 module	5550	1/5
5764 01	Graphic casual plate - 8 module	6122	1/5
5758 89	Graphic casual plate - 2x4 module	7708	1/10
5758 90	Graphic casual plate - 2x6 module	9542	1/8

Silver Baroque plates with Overmoulded frame

5758 53	Silver Baroque plate -1 module	2486	1/5/30
5758 54	Silver Baroque plate - 2 module	2674	1/5/30
5758 55	Silver Baroque plate - 3 module	2874	1/20
5758 56	Silver Baroque plate - 4 module	3066	1/20
5758 57	Silver Baroque plate - 6 module	5550	1/5
5758 58	Silver Baroque plate - 8 module	6122	1/5
5758 59	Silver Baroque plate - 2x4 module	7708	1/10
5758 60	Silver Baroque plate - 2x6 module	9542	1/8
5758 61	Silver Baroque plate for shaver socket 3 module	3924	1/5/50

Dark Baroque plates with Overmoulded frame

5758 62	Dark Baroque plate - 1 module	2484	1/5/30
5758 63	Dark Baroque plate - 2 module	2674	1/5/30
5758 64	Dark Baroque plate - 3 module	2874	1/20
5758 65	Dark Baroque plate - 4 module	3066	1/20
5758 66	Dark Baroque plate - 6 module	5550	1/5
5758 67	Dark Baroque plate - 8 module	6122	1/5
5758 68	Dark Baroque plate - 2x4 module	7706	1/10
5758 69	Dark Baroque plate - 2x6 module	9542	1/8
5758 70	Dark Baroque plate for shaver socket 3 module	3924	1/5/50

Metal finish cover plates with Overmoulded frame

5762 90	Gold brass plate - 1 module	3336	1/5/30
5763 10	Gold brass plate - 2 module	3568	1/5/30
5763 30	Gold brass plate -3 module	3840	1/20
5763 50	Gold brass plate - 4 module	4076	1/20
5763 80	Gold brass plate - 6 module	7414	1/5
5764 00	Gold brass plate - 8 module	8150	1/5
5757 06	Stainless steel plate - 1 module	3336	1/5/30
5757 16	Stainless steel plate - 2 module	3568	1/5/30
5757 26	Stainless steel plate - 3 module	3840	1/20
5757 36	Stainless steel plate - 4 module	4076	1/20
5757 46	Stainless steel plate - 6 module	7414	1/5
5757 66	Stainless steel plate - 2x4 module	10306	1/10
5757 56	Stainless steel plate - 8 module	8150	1/5
5757 76	Stainless steel plate - 2x6 module	12702	1/8

Wood cover plates with Overmoulded frame

5758 80	Grey Oak plate - 1 module	1954	1/5/30
5758 81	Grey Oak plate - 2 module	2074	1/5/30
5758 82	Grey Oak plate - 3 module	2560	1/20
5758 83	Grey Oak plate - 4 module	2836	1/20

* MRP - Maximum Retail Price Inclusive of all taxes including GST.
Red Cat.Nos - new products

Bold Cat.Nos are products normally available with Legrand (India) Stockists.
Cat.Nos that are not bold - delivery within 4 - 8 weeks from the date of order.
Bold packing quantity is our mandatory packing. Orders to be placed by Legrand (India) Stockist in multiples of the same.

Arteor™

square cover plates

Cat.Nos	Description	MRP* ₹ / Unit	Pack
---------	-------------	------------------	------

Wood cover plates with Overmoulded frame

5758 84	Grey Oak plate - 6 module	4212	1/5
5758 85	Grey Oak plate - 8 module	5068	1/5
5758 86	Grey Oak plate - 2x4 module	6014	1/10
5758 87	Grey Oak plate - 2x6 module	8062	1/8
5758 88	Grey Oak plate for shaver socket 3 module	2498	1/5/50

Signature cover plates with Overmoulded frame

5758 71	Cube plate - 1 module	6392	1/5/30
5758 72	Cube plate - 2 module	6510	1/5/30
5758 73	Cube plate - 3 module	7444	1/20
5758 74	Cube plate - 4 module	7692	1/20
5758 75	Cube plate - 6 module	10016	1/5
5758 76	Cube plate - 8 module	10516	1/5
5758 77	Cube plate - 2x4 module	15710	1/10
5758 78	Cube plate - 2x6 module	17402	1/8
5758 79	Cube plate for shaver socket 3 module	7138	1/5/50

Round cover plates with Metal Frame

White cover plates with Metal frame

5759 00	White plate - 2 module	380	10/100
5759 10	White plate - 3 module	400	10/100
5759 20	White plate - 4 module	424	5/50
5759 30	White plate - 6 module	770	5/30
5765 80	White plate - 8 module	852	5/30
5759 40	White plate - 2x4 module	900	2/20
5759 50	White plate - 2x6 module	1312	2/16

Pearl Aluminium cover plates with Metal frame

5757 93	Pearl Aluminium plate - 2 module	506	10/100
5757 94	Pearl Aluminium plate - 3 module	548	10/100
5757 95	Pearl Aluminium plate - 4 module	618	5/50
5757 96	Pearl Aluminium plate - 6 module	1054	5/30
5757 97	Pearl Aluminium plate - 8 module	1166	5/30
5757 98	Pearl Aluminium plate - 2x4 module	1472	2/20
5757 99	Pearl Aluminium plate - 2x6 module	1918	2/16

Graphite cover plates with Metal frame

5758 03	Graphite plate - 2 module	506	10/100
5758 04	Graphite plate - 3 module	548	10/100
5758 05	Graphite plate - 4 module	618	5/50
5758 06	Graphite plate - 6 module	1050	5/30
5758 07	Graphite plate - 8 module	1166	5/30
5758 08	Graphite plate - 2x4 module	1472	2/20
5758 09	Graphite plate - 2x6 module	1918	2/16

Magnesium cover plates with Metal frame

5756 23	Magnesium plate - 2 module	506	10/100
5756 24	Magnesium plate - 3 module	548	10/100
5756 25	Magnesium plate - 4 module	618	5/50
5756 26	Magnesium plate - 6 module	1050	5/30
5756 27	Magnesium plate - 8 module	1164	5/30
5756 28	Magnesium plate - 2x4 module	1472	2/20
5756 29	Magnesium plate - 2x6 module	1918	2/16

* MRP - Maximum Retail Price Inclusive of all taxes including GST.
Red Cat.Nos - new products

Arteor™

round cover plates

Cat.Nos	Description	MRP* ₹ / Unit	Pack
---------	-------------	------------------	------

Champagne cover plates with Metal frame

5758 91	Champagne plate - 2 module	506	10/100
5758 92	Champagne plate - 3 module	548	10/100
5758 93	Champagne plate - 4 module	618	5/50
5758 94	Champagne plate - 6 module	1050	5/30
5758 95	Champagne plate - 8 module	1166	5/30
5758 96	Champagne plate - 2x4 module	1474	2/20
5758 97	Champagne plate - 2x6 module	1918	2/16

Dark Bronze cover plates with Metal frame

5756 93	Dark Bronze plate - 2 module	506	10/100
5756 94	Dark Bronze plate - 3 module	548	10/100
5756 95	Dark Bronze plate - 4 module	616	5/50
5756 96	Dark Bronze plate - 6 module	1050	5/30
5756 97	Dark Bronze plate - 8 module	1164	5/30
5756 98	Dark Bronze plate - 2x4 module	1472	2/20
5756 99	Dark Bronze plate - 2x6 module	1918	2/16

Pearl aluminium cover plates with Overmoulded frame

5759 01	Pearl aluminium plate - 2 module	574	10/100
5759 11	Pearl aluminium plate - 3 module	604	10/100
5759 21	Pearl aluminium plate - 4 module	642	5/50
5759 31	Pearl aluminium plate - 6 module	1166	5/30
5765 81	Pearl aluminium plate - 8 module	1282	5/30
5759 41	Pearl aluminium plate - 2x4 module	1346	2/20
5759 51	Pearl aluminium plate - 2x6 module	1994	2/16

Graphite cover plates with Overmoulded frame

5759 02	Graphite plate - 2 module	574	10/100
5759 12	Graphite plate - 3 module	604	10/100
5759 22	Graphite plate - 4 module	642	5/50
5759 32	Graphite plate - 6 module	1166	5/30
5765 82	Graphite plate - 8 module	1282	5/30
5759 42	Graphite plate - 2x4 module	1346	2/20
5759 52	Graphite plate - 2x6 module	1994	2/16

Magnesium cover plates with Overmoulded frame

5768 41	Magnesium plate - 2 module	574	10/100
5768 42	Magnesium plate - 3 module	604	10/100
5768 43	Magnesium plate - 4 module	642	5/50
5768 44	Magnesium plate - 6 module	1166	5/30
5768 45	Magnesium plate - 8 module	1282	5/30
5768 46	Magnesium plate - 2x4 module	1346	2/20
5768 47	Magnesium plate - 2x6 module	1994	2/16

Champagne cover plates with Overmoulded frame

5768 48	Champagne plate - 2 module	574	10/100
5768 49	Champagne plate - 3 module	604	10/100
5768 50	Champagne plate - 4 module	642	5/50
5768 51	Champagne plate - 6 module	1166	5/30
5768 52	Champagne plate - 8 module	1282	5/30
5768 53	Champagne plate - 2x4 module	1346	2/20
5768 54	Champagne plate - 2x6 module	1994	2/16

Bold Cat.Nos are products normally available with Legrand (India) Stockists. Cat.Nos that are not bold - delivery within 4 - 8 weeks from the date of order. Bold packing quantity is our mandatory packing. Orders to be placed by Legrand (India) Stockist in multiples of the same.

Arteor™ round cover plates

Cat.Nos	Description	MRP* ₹ / Unit	Pack
---------	-------------	------------------	------

Dark Bronze cover plates with Overmoulded frame

5768 55	Dark Bronze plate - 2 module	574	10/100
5768 56	Dark Bronze plate - 3 module	604	10/100
5768 57	Dark Bronze plate - 4 module	642	5/50
5768 58	Dark Bronze plate - 6 module	1166	5/30
5768 59	Dark Bronze plate - 8 module	1282	5/30
5768 60	Dark Bronze plate - 2x4 module	1346	2/20
5768 61	Dark Bronze plate - 2x6 module	1994	2/16

Mirror finish cover plates with Overmoulded frame

5759 03	Mirror black plate - 2 module	2414	1/5/30
5759 13	Mirror black plate - 3 module	2586	1/20
5759 23	Mirror black plate - 4 module	2752	1/20
5759 33	Mirror black plate - 6 module	4980	1/5
5765 83	Mirror black plate - 8 module	5500	1/5
5759 43	Mirror black plate - 2x4 module	6484	1/10
5759 53	Mirror black plate - 2x6 module	8572	1/8
5759 04	Mirror white plate - 2 module	2414	1/5/30
5759 14	Mirror white plate - 3 module	2586	1/20
5759 24	Mirror white plate - 4 module	2752	1/20
5759 34	Mirror white plate - 6 module	4980	1/5
5765 84	Mirror white plate - 8 module	5500	1/5
5759 44	Mirror white plate - 2x4 module	6620	1/10
5759 54	Mirror white plate - 2x6 module	8572	1/8
5768 62	Green Apple plate - 2 module	2414	1/5/30
5768 63	Green Apple plate - 3 module	2586	1/20
5768 64	Green Apple plate - 4 module	2752	1/20
5768 65	Green Apple plate - 6 module	4978	1/5
5768 66	Green Apple plate - 8 module	5500	1/5
5768 67	Green Apple plate - 2x4 module	6616	1/10
5768 68	Green Apple plate - 2x6 module	8572	1/8

Graphic cover plates with overmoulded frames

5763 01	Graphic casual plate - 2 module	2946	1/5/30
5763 21	Graphic casual plate - 3 module	3156	1/20
5763 41	Graphic casual plate - 4 module	3368	1/20
5763 61	Graphic casual plate - 6 module	6108	1/5
5763 91	Graphic casual plate - 8 module	6726	1/5
5768 97	Graphic casual plate - 2X4 module	8068	1/10
5768 98	Graphic casual plate - 2X6 module	10494	1/8

Round cover plates Silver Baroque cover plates with Overmoulded frame

5768 69	Silver Baroque plate - 2 module	2946	1/5/30
5768 70	Silver Baroque plate - 3 module	3156	1/20
5768 71	Silver Baroque plate - 4 module	3368	1/20
5768 72	Silver Baroque plate - 6 module	6108	1/5
5768 73	Silver Baroque plate - 8 module	6726	1/5
5768 74	Silver Baroque plate - 2x4 module	8068	1/10
5768 75	Silver Baroque plate - 2x6 module	10494	1/8

* MRP - Maximum Retail Price Inclusive of all taxes including GST.
Red Cat.Nos - new products

Arteor™ round cover plates

Cat.Nos	Description	MRP* ₹ / Unit	Pack
---------	-------------	------------------	------

Dark Baroque cover plates with Overmoulded frame

5768 76	Dark Baroque plate - 2 module	2946	1/5/30
5768 77	Dark Baroque plate - 3 module	3156	1/20
5768 78	Dark Baroque plate - 4 module	3368	1/20
5768 79	Dark Baroque plate - 6 module	6108	1/5
5768 80	Dark Baroque plate - 8 module	6726	1/5
5768 81	Dark Baroque plate - 2x4 module	8068	1/10
5768 82	Dark Baroque plate - 2x6 module	10494	1/8

Metal finish cover plates with Overmoulded frame

5763 00	Gold brass plate - 2 module	3936	1/5/30
5763 20	Gold brass plate - 3 module	4202	1/20
5763 40	Gold brass plate - 4 module	4484	1/20
5763 60	Gold brass plate - 6 module	8146	1/5
5763 90	Gold brass plate - 8 module	8974	1/5
5759 06	Stainless steel plate - 2 module	3936	1/5/30
5759 16	Stainless steel plate - 3 module	4202	1/20
5759 26	Stainless steel plate - 4 module	4484	1/20
5759 36	Stainless steel plate - 6 module	8146	1/5
5765 86	Stainless steel plate - 8 module	8974	1/5
5759 46	Stainless steel plate - 2x4 module	11348	1/10
5759 56	Stainless steel plate - 2x6 module	13966	1/8

Wood cover plates with Overmoulded frame

5768 90	Grey Oak plate - 2 module	2072	1/5/30
5768 91	Grey Oak plate - 3 module	3064	1/20
5768 92	Grey Oak plate - 4 module	3178	1/20
5768 93	Grey Oak plate - 6 module	4512	1/5
5768 94	Grey Oak plate - 8 module	5498	1/5
5768 95	Grey Oak plate - 2x4 module	5874	1/10
5768 96	Grey Oak plate - 2x6 module	7518	1/8

Signature cover plates with Overmoulded frame

5768 83	Cube plate - 2 module	6510	1/5/30
5768 84	Cube plate - 3 module	7910	1/20
5768 85	Cube plate - 4 module	8056	1/20
5768 86	Cube plate - 6 module	10312	1/5
5768 87	Cube plate - 8 module	10940	1/5
5768 88	Cube plate - 2x4 module	15218	1/10
5768 89	Cube plate - 2x6 module	17222	1/8

Bold Cat.Nos are products normally available with Legrand (India) Stockists.
Cat.Nos that are not bold - delivery within 4 - 8 weeks from the date of order.
Bold packing quantity is our mandatory packing. Orders to be placed by Legrand (India) Stockist in multiples of the same.

Arteor™ mounting boxes

Cat.Nos	Description	MRP* ₹ / Unit	Pack
---------	-------------	------------------	------

Accessories

Plastic surface boxes

5734 91	Surface box - 1/2 module	132	10/50
5735 20	Surface box - 3 module	158	5/35
5735 70	Surface box - 4 module	190	5/25
5735 71	Surface box - 6 module	236	1/10
5723 94	Surface box - 8 module	264	1/10
5735 74	Surface box - 2x4 module	326	2/10
5735 72	Surface box - 12/16 module	832	2/10
5735 73	Surface box - 18/24 module	882	2/8

Metal flush boxes

6890 07	Metal flush mounting Box - 1/2 module	142	40
6890 08	Metal flush mounting Box - 3 module	142	40
6890 09	Metal flush mounting Box - 4 module	188	40
6890 10	Metal flush mounting Box - 6 module	298	40
6890 42	Metal flush mounting Box - 8 module	348	40
6890 31	Metal flush mounting Box - 4x2 module	346	20
6890 11	Metal flush mounting Box - 12 /16 module	524	10
6890 12	Metal flush mounting Box - 18 / 24 module	658	10

IP 55 Plexo box and accessories

6846 38	Grey Plexo box & adaptor with transparent flap for 3 modules, IP 66	5080	1
---------	---	------	---

IP 55 Plexo box with PVC membrane

6806 11	Grey Plexo box & adaptor with PVC membrane - 1 module	1120	10
6806 12	Grey Plexo box & adaptor with PVC membrane - module	1146	10
6806 13	Grey Plexo box & adaptor with PVC membrane - module	1524	10
6806 14	Grey Plexo box & adaptor with PVC membrane - 4 module	2286	5
6806 19	Grey Plexo box & adaptor with PVC membrane - 2 row x 4 module	3706	5
6806 33	Grey Plexo flush adaptor with membrane for 3 module Arteor™ box	1218	20

* MRP - Maximum Retail Price Inclusive of all taxes including GST.
Red Cat.Nos - new products

Arteor™

Guarantee

- The Company, at its discretion, will replace products if they have any manufacturing defect within 10 years for switches (without LED lamp) and power sockets. For all other **Arteor™** wiring accessories the guarantee will be 2 years.
- The above guarantee is applicable when the devices are used in Legrand metal flush boxes. Otherwise the guarantee period will be reduced by 50%.
- The guarantee is only applicable when the products are installed as per the Company's instructions and not tampered in any manner.
- The guarantee states the Company's entire liability. It does not extend to cover consequential loss or damage or installation costs arising from defective products.



5735 70



6890 07



6890 08



6890 09



6890 12



6846 38



6806 12



6806 13



6806 19



6806 33

ARTEOR™ IoT

ADD A TOUCH OF SMARTNESS

THE SMART RADIO SOLUTION

Arteor IoT offer, a radio-based solution for the connected home. The intelligent products communicate with one another via radio ZigBee 3.0 (2.4 GHz waveband). This means there is no need for specific or extensive cabling. Also, although the range only contains a few products, these can be used to create lots of individual solutions for a more customized feel at home.

SIMPLE, ADAPTABLE, OPEN

Radio-based Arteor has been designed and developed as a simple solution to make every house more individual, convenient and secure. Simple for planners, who are able to integrate many useful functions without having to provide for complicated cabling. Simple for installers, who are able to install the system without a great deal of effort or specialist knowledge. Simple for users, who will find it convenient to operate, easy to extend and are able to make changes at any time.



THE HOME + CONTROL APP FOR SMARTPHONE OR TABLET

The app on the smartphone or tablet opens up new options: monitoring of instantaneous power consumption, remote surveillance of the connected home, and control over various functions when the user is out and about.



Scan to know more about
the product.



LOCAL CONTROL GUARANTEED

Of course, all functions can still be used in the traditional way via switches on the wall. If furniture needs to be rearranged or small children need to be able to reach a switch, the wireless switches can be repositioned easily at any time.



Home + Control App

iPhone, iPod and iPad are registered trademarks of Apple Inc., registered in the US and other countries. HomeKit is a trademark of Apple Inc. App store is a service mark of Apple Inc., Google, Android, Google Play, and the Google Play logo are trademarks of Google LLC. Amazon, Alexa and all related logos are trademarks of Amazon.com, Inc. or its affiliates.

ARTEOR™

IoT

SMART HOMES,
SMARTER
CONVENIENCE!

**COMPACT & THOUGHTFUL FOR
ENHANCED CONVENIENCE!**

At Legrand, it our promise to enhance convenience at every point of interaction. The process of designeering that we follow ensures the best of fusion between the design and engineering. Arteor range launched in 2019, has witness huge success due to its unique style and unmatched range of functions. Further raising the bar, Arteor IoT range is enhanced with 6 new products, to ensure that you live the advantage.



**DIMMER WITH
NEUTRAL 1M 150W**



**4 SCENARIO CONTROL
WIRELESS SW**



**WIRELESS
2 GANG SWITCH**

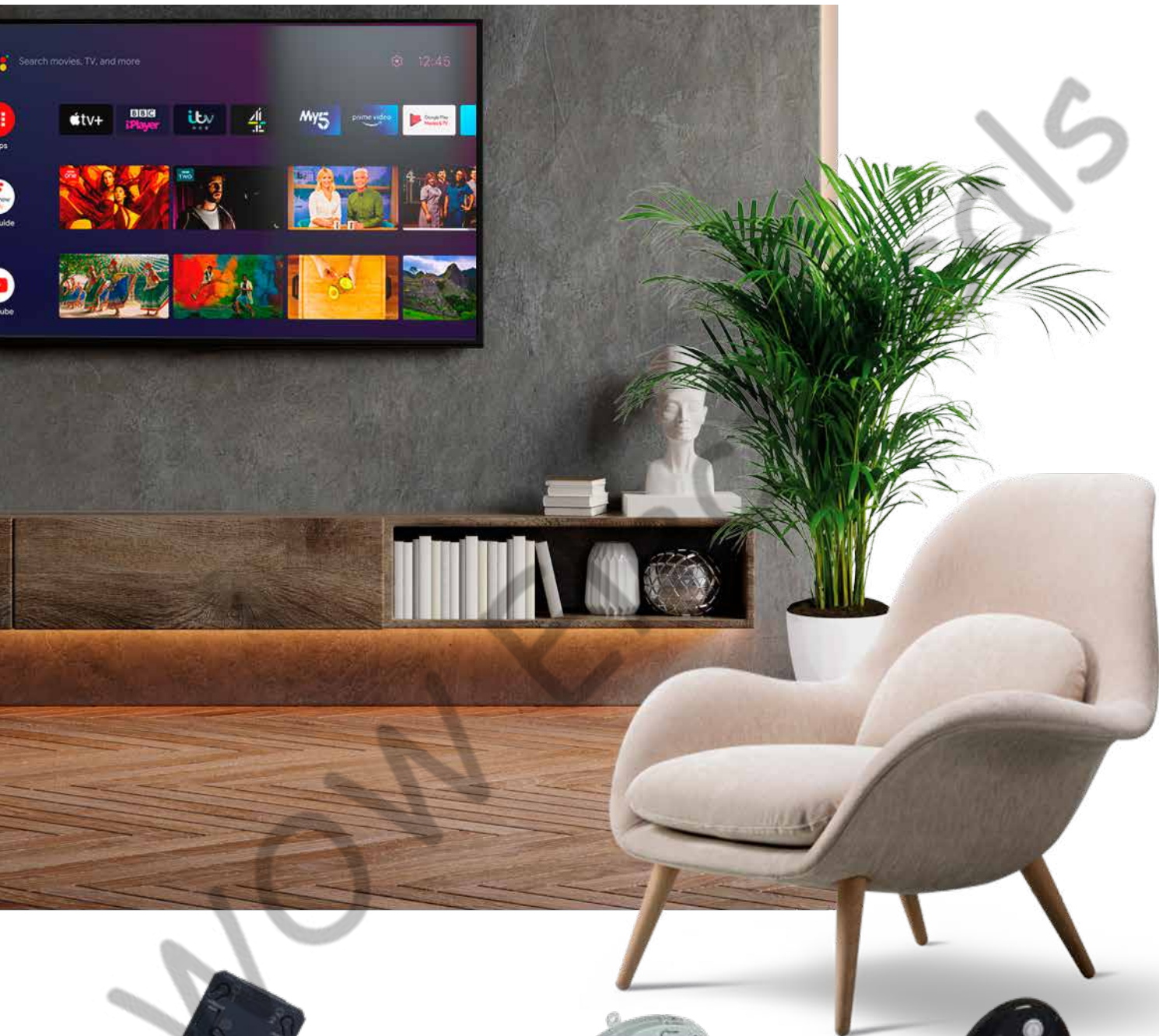

AUXILIARY WIRELESS SWITCH



SHUTTER MICRO MODULE



PORTABLE REMOTE

CX³

ADDING COMFORT IS SIMPLICITY ITSELF

With our smart electrical panel solutions and the Home + Control app, you have the benefit of a complete system for controlling your electrical installation on any type of site, from private houses to large blocks of flats.



GATEWAY MODULE





SMART CONTACTOR



SMART LATCHING RELAY



SMART ECOMETER



ENERGY METER



SMART LOAD SHEDDER



Voice Control



Ease of Scheduling



Smart Energy Management

Arteor™

Connected Home - white mechanism

Cat.Nos	Description	MRP* ₹ / Unit	Pack
---------	-------------	------------------	------

Connected light switches

5742 01	Switch with neutral, wired, 1 module	9130	1/24
5742 02	Switch without neutral, with dimmer option, wired, 2 modules	15354	1/12
5743 40	Switch dimmer with neutral 150w, 1 mod	10484	1

Connected outlets

5742 00	Connected socket outlet module - 16A - 240VA - 3680 W, 1 module	10498	1/12
---------	---	-------	------

Connected curtain/roller blind switches

5742 04	Connected curtain/roller blind switch wired, 1 module	11210	1/24
---------	---	-------	------

Connected gateway pack

5742 09	Connected gateway + Master home away wireless switch wired, 2 module	22562	1/4
---------	--	-------	-----

Connected wireless controls

5742 05	Wireless light switch	4832	1/10
5742 44	2G wireless switch	5566	1
5742 07	Curtain/roller blind wireless switch	5572	1/10

Connected wireless scene switches

5742 06	Home/Away wireless master switch	5628	1/10
5742 08	Wake up/Sleep wireless switch	5628	1/10
5743 12	Wireless 4 scenes switch	7028	1

Magnesium Mechanism connected light switches

5742 20	Switch with neutral, wired, 1 module	10502	1/24
5742 21	Switch without neutral, with dimmer option, wired, 2 modules	17654	1/12
574342	Switch Dimmer With Neutral 150w, 1 Mod	12056	1

Connected outlets

5742 28	Connected socket outlet module - 16A - 240VA - 3680 W, 1 module	12196	1/12
---------	---	-------	------

Connected curtain/roller blind switches

5742 22	Connected curtain/roller blind switch wired, 1 module	12886	1/24
---------	---	-------	------

Connected gateway pack

5742 27	Connected gateway + Master home away wireless switch wired, 2 module	25940	1/4
---------	--	-------	-----

* MRP - Maximum Retail Price Inclusive of all taxes including GST.
 # To be Introduced Shortly
 (1) Supplied with white plate
 ■ Price available on request

Arteor™

Connected Home - magnesium

Cat.Nos	Description	MRP* ₹ / Unit	Pack
---------	-------------	------------------	------

Connected wireless controls

5742 23	Wireless light switch - 1-gang	5616	1/10
5742 46	2G wireless switch	6400	1
5742 25	Curtain/roller blind wireless switch	6410	1/10

Connected wireless scene switches

5742 24	Home/Away wireless master switch	6476	1/10
5742 26	Wake up/Sleep wireless switch	6476	1/10
5743 14	Wireless 4 scenes switch	8084	1

Champagne Mechanism Connected light switches

5742 29	Switch with neutral, wired, 1 module	10502	1/24
5742 30	Switch without neutral, with dimmer option, wired, 2 modules	17654	1/12
5743 43	Switch dimmer with neutral 150w, 1 mod	12056	1

Connected outlets

5742 37	Connected socket outlet module - 16A - 240VA - 3680 W, 1 module	12196	1/12
---------	---	-------	------

Connected curtain/roller blind switches

5742 31	Connected curtain/roller blind switch wired, 1 module	12886	1/24
---------	---	-------	------

Connected gateway pack

5742 36	Connected gateway + Master home away wireless switch wired, 2 module	25940	1/4
---------	--	-------	-----

Connected wireless controls

5742 32	Wireless light switch - 1-gang	5560	1/10
5742 47	2G wireless switch	6400	1
5742 34	Curtain/roller blind wireless switch	6410	1/10

Connected wireless scene switches

5742 33	Home/Away wireless master switch	6476	1/10
5742 35	Wake up/Sleep wireless switch	6476	1/10
5743 15	Wireless 4 scenes switch	8084	1

Micro module switch

5742 43	Micro module switch with neutral, 300 W	7788	1/24
0676 97	Shutter micromodule	10106	1
0676 94	Wireless switch on/off module for mechanical switch (auxiliary)	9454	1
0676 95	Portable remote	12462	1

Bold Cat.Nos are products normally available with Legrand (India) Stockists. Cat.Nos that are not bold - delivery within 4 - 8 weeks from the date of order. Bold packing quantity is our mandatory packing. Orders to be placed by Legrand (India) Stockist in multiples of the same.

Arteor™

cover plates

Cat.Nos	Description	MRP* ₹ / Unit	Pack
---------	-------------	------------------	------

COVER PLATES

White cover plates with Overmoulded frame

5758 98	White plate - 1 module	348	10/100
5758 99	White plate - 2 module	360	10/100
5759 60	White plate - 3 module	418	10/100
5759 65	White plate - 4 module	480	5/50
5759 94	White plate - 6 module	660	5/30
5759 95	White plate - 8 module	780	5/30
5759 96	White plate - 2x4 module	1140	2/20
5759 97	White plate - 2x6 module	1516	2/16
5759 98	White plate - 2x8 module	1666	2/16
5759 99	White plate - 3x6 module	1962	2/12

Pearl aluminium cover plates with Overmoulded frame

5757 01	Pearl aluminium plate - 1 module	412	10/100
5757 11	Pearl aluminium plate - 2 module	436	10/100
5757 21	Pearl aluminium plate - 3 module	464	10/100
5757 31	Pearl aluminium plate - 4 module	524	5/50
5757 41	Pearl aluminium plate - 6 module	894	5/30
5757 51	Pearl aluminium plate - 8 module	992	5/30
5757 61	Pearl aluminium plate - 2x4 module	1258	2/20
5757 71	Pearl aluminium plate - 2x6 module	1636	2/16
5757 81	Pearl aluminium plate - 2x8 module	1856	2/16
5757 91	Pearl aluminium plate - 3x6 module	2170	2/12

Graphite cover plates with Overmoulded frame

5757 02	Graphite plate - 1 module	412	10/100
5757 12	Graphite plate - 2 module	436	10/100
5757 22	Graphite plate - 3 module	464	10/100
5757 32	Graphite plate - 4 module	524	5/50
5757 42	Graphite plate - 6 module	894	5/30
5757 52	Graphite plate - 8 module	992	5/30
5757 62	Graphite plate - 2x4 module	1258	2/20
5757 72	Graphite plate - 2x6 module	1636	2/16
5757 82	Graphite plate - 2x8 module	1856	2/16
5757 92	Graphite plate - 3x6 module	2170	2/12

Arteor™

cover plates

Cat.Nos	Description	MRP* ₹ / Unit	Pack
---------	-------------	------------------	------

Magnesium cover plates with Overmoulded frame

5758 11	Magnesium plate - 1 module	412	10/100
5758 12	Magnesium plate - 2 module	436	10/100
5758 13	Magnesium plate - 3 module	464	10/100
5758 14	Magnesium plate - 4 module	524	5/50
5758 15	Magnesium plate - 6 module	894	5/30
5758 16	Magnesium plate - 8 module	992	5/30
5758 17	Magnesium plate - 2x4 module	1258	2/20
5758 18	Magnesium plate - 2x6 module	1636	2/16
5758 19	Magnesium plate - 2x8 module	1856	2/16
5758 20	Magnesium plate - 3x6 module	2170	2/12

Champagne cover plates with Overmoulded frame

5758 22	Champagne plate - 1 module	412	10/100
5758 23	Champagne plate - 2 module	436	10/100
5758 24	Champagne plate - 3 module	464	10/100
5758 25	Champagne plate - 4 module	524	5/50
5758 26	Champagne plate - 6 module	894	5/30
5758 27	Champagne plate - 8 module	992	5/30
5758 28	Champagne plate - 2x4 module	1258	2/20
5758 29	Champagne plate - 2x6 module	1636	2/16
5758 30	Champagne plate - 2x8 module	1856	2/16
5758 31	Champagne plate - 3x6 module	2170	2/12

Dark Bronze cover plates with Overmoulded frame

5758 33	Dark Bronze plate - 1 module	412	10/100
5758 34	Dark Bronze plate - 2 module	436	10/100
5758 35	Dark Bronze plate - 3 module	464	10/100

* MRP - Maximum Retail Price Inclusive of all taxes including GST.

■ To be Introduced Shortly

(1) Supplied with white plate

■ Price available on request

Bold Cat.Nos are products normally available with Legrand (India) Stockists. Cat.Nos that are not bold - delivery within 4 - 8 weeks from the date of order. Bold packing quantity is our mandatory packing. Orders to be placed by Legrand (India) Stockist in multiples of the same.

Arteor™ cover plates

Cat.Nos	Description	MRP* ₹ / Unit	Pack
---------	-------------	------------------	------

Dark Bronze cover plates with Overmoulded frame

5758 36	Dark Bronze plate - 4 module	524	5/50
5758 37	Dark Bronze plate - 6 module	894	5/30
5758 38	Dark Bronze plate - 8 module	992	5/30
5758 39	Dark Bronze plate - 2x4 module	1258	2/20
5758 40	Dark Bronze plate - 2x6 module	1636	2/16
5758 41	Dark Bronze plate - 2x8 module	1856	2/16
5758 42	Dark Bronze plate - 3x6 module	2170	2/12

Mirror finish cover plates with Overmoulded frame

5757 03	Mirror black plate - 1 module	2048	1/5/30
5757 13	Mirror black plate - 2 module	2188	1/5/30
5757 23	Mirror black plate - 3 module	2344	1/20
5757 33	Mirror black plate - 4 module	2492	1/20
5757 43	Mirror black plate - 6 module	4534	1/5
5757 53	Mirror black plate - 8 module	4994	1/5
5757 63	Mirror black plate - 2x4 module	6328	1/10
5757 73	Mirror black plate - 2x6 module	7786	1/8
5757 04	Mirror white plate - 1 module	2048	1/5/30
5757 14	Mirror white plate - 2 module	2188	1/5/30
5757 24	Mirror white plate - 3 module	2344	1/20
5757 34	Mirror white plate - 4 module	2492	1/20
5757 44	Mirror white plate - 6 module	4534	1/5
5757 54	Mirror white plate - 8 module	4994	1/5
5757 64	Mirror white plate - 2x4 module	6446	1/10
5757 74	Mirror white plate - 2x6 module	7786	1/8

Arteor™ cover plates

Cat.Nos	Description	MRP* ₹ / Unit	Pack
---------	-------------	------------------	------

Mirror finish cover plates with Overmoulded frame

5758 44	Green Apple plate - 1 module	2048	1/5/30
5758 45	Green Apple plate - 2 module	2188	1/5/30
5758 46	Green Apple plate - 3 module	2344	1/20
5758 47	Green Apple plate - 4 module	2492	1/20
5758 48	Green Apple plate - 6 module	4534	1/5
5758 49	Green Apple plate - 8 module	4994	1/5
5758 50	Green Apple plate - 2x4 module	6444	1/10
5758 51	Green Apple plate - 2x6 module	7786	1/8

Graphic cover plates with Overmoulded frame

5762 91	Graphic casual plate - 1 module	2486	1/5/30
5763 11	Graphic casual plate - 2 module	2674	1/5/30
5763 31	Graphic casual plate - 3 module	2874	1/5/20
5763 51	Graphic casual plate - 4 module	3066	1/20
5763 81	Graphic casual plate - 6 module	5550	1/5
5764 01	Graphic casual plate - 8 module	6122	1/5
5758 89	Graphic casual plate - 2x4 module	7708	1/10
5758 90	Graphic casual plate - 2x6 module	9542	1/8

Silver Baroque plates with Overmoulded frame

5758 53	Silver Baroque plate - 1 module	2486	1/5/30
5758 54	Silver Baroque plate - 2 module	2674	1/5/30
5758 55	Silver Baroque plate - 3 module	2874	1/20
5758 56	Silver Baroque plate - 4 module	3066	1/20
5758 57	Silver Baroque plate - 6 module	5550	1/5
5758 58	Silver Baroque plate - 8 module	6122	1/5
5758 59	Silver Baroque plate - 2x4 module	7708	1/10

* MRP - Maximum Retail Price Inclusive of all taxes including GST.
 * To be Introduced Shortly
 (1) Supplied with white plate
 ■ Price available on request

Bold Cat.Nos are products normally available with Legrand (India) Stockists. Cat.Nos that are not bold - delivery within 4 - 8 weeks from the date of order. Bold packing quantity is our mandatory packing. Orders to be placed by Legrand (India) Stockist in multiples of the same.

Arteor™

cover plates

Cat.Nos	Description	MRP* ₹ / Unit	Pack
---------	-------------	------------------	------

Silver Baroque plates with Overmoulded frame

5758 60	Silver Baroque plate - 2x6 module	9542	1/8
---------	-----------------------------------	------	-----

Dark Baroque plates with Overmoulded frame

5758 62	Dark Baroque plate - 1 module	2484	1/5/30
5758 63	Dark Baroque plate - 2 module	2674	1/5/30
5758 64	Dark Baroque plate - 3 module	2874	1/20
5758 65	Dark Baroque plate - 4 module	3066	1/20
5758 66	Dark Baroque plate - 6 module	5550	1/5
5758 67	Dark Baroque plate - 8 module	6122	1/5
5758 68	Dark Baroque plate - 2x4 module	7706	1/10
5758 69	Dark Baroque plate - 2x6 module	9542	1/8

Metal finish cover plates with Overmoulded frame

5762 90	Gold brass plate - 1 module	3336	1/5/30
5763 10	Gold brass plate - 2 module	3568	1/5/30
5763 30	Gold brass plate -3 module	3840	1/20
5763 50	Gold brass plate - 4 module	4076	1/20
5763 80	Gold brass plate - 6 module	7414	1/5
5764 00	Gold brass plate - 8 module	8150	1/5
5757 06	Stainless steel plate - 1 module	3336	1/5/30
5757 16	Stainless steel plate - 2 module	3568	1/5/30
5757 26	Stainless steel plate - 3 module	3840	1/20
5757 36	Stainless steel plate - 4 module	4076	1/20
5757 46	Stainless steel plate - 6 module	7414	1/5
5757 66	Stainless steel plate - 2x4 module	10306	1/10
5757 56	Stainless steel plate - 8 module	8150	1/5
5757 76	Stainless steel plate - 2x6 module	12702	1/8



5758 81



5758 72



5758 73

Arteor™

cover plates

Cat.Nos	Description	MRP* ₹ / Unit	Pack
---------	-------------	------------------	------

Wood cover plates with Overmoulded frame

5758 80	Grey Oak plate - 1 module	1954	1/5/30
5758 81	Grey Oak plate - 2 module	2074	1/5/30
5758 82	Grey Oak plate - 3 module	2560	1/20
5758 83	Grey Oak plate - 4 module	2836	1/20
5758 84	Grey Oak plate - 6 module	4212	1/5
5758 85	Grey Oak plate - 8 module	5068	1/5
5758 86	Grey Oak plate - 2x4 module	6014	1/10
5758 87	Grey Oak plate - 2x6 module	8062	1/8

Signature cover plates with Overmoulded frame

5758 71	Cube plate - 1 module	6392	1/5/30
5758 72	Cube plate - 2 module	6510	1/5/30
5758 73	Cube plate - 3 module	7444	1/20
5758 74	Cube plate - 4 module	7692	1/20
5758 75	Cube plate - 6 module	10016	1/5
5758 76	Cube plate - 8 module	10516	1/5
5758 77	Cube plate - 2x4 module	15710	1/10
5758 78	Cube plate - 2x6 module	17402	1/8

Cover plates without frame Plate without frame#

5757 10PL	Plate 2m sq white Suitable only for wireless switch	166	5/50
5757 11PL	Plate 2m sq pearl aluminium Suitable only for wireless switch	334	5/50
5757 12PL	Plate 2m sq graphite Suitable only for wireless switch	264	5/50
5758 12PL	Plate 2m sq magnesium Suitable only for wireless switch	334	5/50
5758 23PL	Plate 2m sq champagne Suitable only for wireless switch	334	5/50
5758 34PL	Plate 2m sq dark bronze Suitable only for wireless switch	334	5/50

Accessory

0648 71	Pack of 3 x 4 extra removable stickers for fixing a wireless control	570	1/25
---------	--	-----	------

* MRP - Maximum Retail Price Inclusive of all taxes including GST.

(1) Supplied with white plate

#Suitable only for wireless switch, ■ Price available on request

Bold Cat.Nos are products normally available with Legrand (India) Stockists. Cat.Nos that are not bold - delivery within 4 - 8 weeks from the date of order. Bold packing quantity is our mandatory packing. Orders to be placed by Legrand (India) Stockist in multiples of the same.

Myrius™



+ Myrius™
More is on.

Experience the best of both worlds as they become one.



As Myrius and Myrius NextGen become one, the comprehensive Myrius brand range will now offer the best of both worlds with designer finishes, beautiful hues and patterns achieved through IMD technology along with IOT functions (currently referred to as Myrius NextGen range) and the classic black and white range (currently referred to as Myrius range) will now be called as Myrius Regular under one brand Myrius.

Myrius:
the best of
both worlds



Myrius

(Comprehensive one brand)

Myrius

(Earlier referred to as Myrius NextGen)



White



Ice Black



Ice White



Interlude



Charcoal Grey



Luminar



Stellar

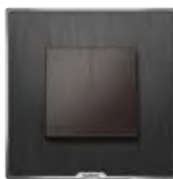

Dark Fade



Sonic Silver



Champagne

Myrius Regular

(Earlier referred to as Myrius)



Snowy white



Black beauty

Myrius™

INSPIRED BY YOUR
LOVE FOR AESTHETICS
AND CONVENIENCE

Who said beauty has to be compromised at the hands of technology! The Myrius range seamlessly combines the aesthetic beauty of designer finishes with hues and patterns, achieved through cutting-edge IMD technology, with the intelligence of IoT functions. This means customized, smart functions for you to enjoy the convenience of living and a stunning designer look that will turn heads, every time guests come over.



Scan to know more about
the product.



Luminar

Trinity

Interlude

Stellar

Sonic Silver

Pearl Champagne

Dark Fade

Ice White

Ice Black

Classic White

Myrius™ switches - classic white

Cat.Nos	Description	MRP ₹ / Unit	Pack
---------	-------------	--------------------	------

Mechanisms Classic White Switches 6A 230VAC

6792 00	6A Switch 1 way 1M	145	20/200
6792 01	6A Switch 2 way 1M	244	20/200
6792 02	6A Switch 1 way 1M with Indicator	226	20/200
6792 03	6A Switch 1 way 1M light marking	192	20/200
6792 04	6A Switch 1 way 1M with fan marking	192	20/200

Switches 10A 230VAC

6792 05	10A Switch 1 way 2M	284	10/100
6792 06	10A Switch 2 way 2M	336	10/100
6792 07	10A intermediate Switch 2M	1834	10/100
6792 08	10A Switch 1 way 2M with Indicator	352	10/100

Switches 16A 230VAC

6792 09	16A Switch 1 way 1M	320	20/200
6792 10	16A Switch 2 way 1M	366	20/200
6792 11	16A Switch 1 way 1M with Indicator	388	20/200

Switches 20A 230VAC

6792 12	20A Switch 1 way 1M	426	20/200
6792 13	20A DP Switch 1 way 2M	648	10/100
6792 14	20A DP Switch 1 way 2M with Indicator	692	10/100
6792 15	20A Switch 2 way 2M	716	10/100

Sockets, Regulators, Hospitality Function Switches 25A 230VAC

6792 16	25A SP 1 way with Indicator 1M	476	20/200
---------	--------------------------------	-----	--------

Switches 32A 230VAC

6792 17	32A DP Switch 2M with Indicator	1060	10/100
---------	---------------------------------	------	--------

Myrius™ sockets, regulators, hospitality function

Cat.Nos	Description	MRP ₹ / Unit	Pack
---------	-------------	--------------------	------

Push button 6A 230VAC

6792 18	6A push button SP 1M	270	20/200
6792 19	6A push button SP 1 way 1M with Indicator	352	20/200
6792 20	6A bell push 1 way 1M	268	20/200
6792 21	6A bell push 1 way 1M with Indicator	352	20/200
6792 22	6A bell push 1 way 2M	406	10/100
6792 23	6A bell push 1 way 2M with Indicator	476	10/100

Accessories for switches

6792 24	Lamp for Switches 230V AC	62	5/50
---------	---------------------------	----	------

Sockets, Regulators, Hospitality Function Sockets 240VAC

6792 26	16A 3 Pin Switched Socket 3M	1212	5/50
6792 29	6/16A - ISI - Socket 3 module	562	5/50
6792 30	6/16A - ISI - Socket 2 module	470	10/100
6792 32	25A Socket 2M	596	10/100
6792 35	6A 3-Pin ISI socket 2 module	240	1/20/200

Dimmers And Fan regulators

6792 36	Rotary Dimmer 400W 1M	1172	5/50
6792 37	Rotary Light Dimmer 500W 2M	1768	10/100
6792 39	Fan Regulator 100W ISI 1M	910	5/50
6792 40	Fan Regulator 100W 360 Degree ISI 2M	1042	10/100
6792 41	Fan Regulator 120W 360 Degree ISI 2M	1128	10/100
6792 42	Fan Regulator 70W ISI 2M	1092	1/10/100
6792 31	Fan regulator 8 step 100w 2 Module	954	1/10/100

* MRP - Maximum Retail Price Inclusive of all taxes including GST.
■ Price available on request

Bold Cat.Nos are products normally available with Legrand (India) Stockists. Cat.Nos that are not bold - delivery within 4 - 8 weeks from the date of order. Bold packing quantity is our mandatory packing. Orders to be placed by Legrand (India) Stockist in multiples of the same.

Myrius™ hospitality functions, sockets, electronic function

Cat.Nos	Description	MRP ₹ / Unit	Pack
---------	-------------	--------------------	------

Emergency Light

6792 43	Removable LED lamp 2M	2930	1/10/100
---------	-----------------------	------	----------

Skirting Light

6792 48	Skirting light with warm White LED 3M	886	5/25
---------	---------------------------------------	-----	------

Indicator

6792 87	Indicator Unit 1M W/ transparent LED W/ colored labels	682	1/10/100
---------	--	-----	----------

Bell call indicator

6792 49	Bell call Indicator 1M	1164	20/200
---------	------------------------	------	--------

Buzzer

6792 50	Buzzer 230V 1M	1262	20/200
---------	----------------	------	--------

Infrared Sensors

6792 51	Infrared Sensor Switch 400W 2M	2062	1/50
---------	--------------------------------	------	------

Remote Unit

6792 52	Remote control unit for Light and Fan 4M	7034	1/5/20
6793 03	Remote control hand unit	622	1/5/30

Hospitality Function Hotel Keycard Switch

6792 53	16A Hotel key FOB Switch 2M	4220	1/10
6792 55	Credit card size Key FOB	184	10/100

Hospitality Functions, Sockets, Electronic Function

Hotel "DND And MMR" functions

6792 56	DND & MMR INDICATOR 1M + 1M BELL PUSH	1800	10/100
6792 57	DND & MMR (INSIDE)	1202	10/100

Shaver socket

6792 58	Shaver Socket 110/230vac Monoblock With Plate 2m	3140	1/16
6792 59	Shaver Skt 110/230vac Monoblock With Plate 4m	5128	1/5/20

SocketsAnd connectors TV sockets

6792 60	TV co-axial Socket	238	20/200
---------	--------------------	-----	--------

Data & Voice

6792 62	RJ11 Telephone	236	20/200
6792 63	Double RJ11 Telephone	362	20/200
6792 64	RJ 45 UTP cat 5 tooless with shutter 1M	522	20/200
6792 65	RJ 45 UTP cat 6 tooless with shutter 1M	776	20/200
6792 66	RJ 45 UTP cat 6 tooless with shutter 2M	790	10/100

Myrius™ electronic function, switches - charcoal grey

Cat.Nos	Description	MRP ₹ / Unit	Pack
---------	-------------	--------------------	------

Audio Video Connectors

6792 67	Preterminated AV connector 1M	1840	1/10
6792 68	Preterminated projector connector 1M	2254	1/10
6792 69	Preterminated HDMI Socket 1M	2254	1/10

Sound (Volume controller)

6792 70	Volume controller 2M	1376	1/10/100
---------	----------------------	------	----------

Protectors and Accessories Motor Starter

6792 71	16A Motor starter 2M	752	1/10/100
6792 72	25A Motor starter 2M	768	1/10/100

Electronic Function USB chargers (IS13252 (Part 1) / IEC 60950-1)

6792 88	USB Charger 1500mA Type A-1 module	1638	1/5/50
6792 89	Double USB Charger 3000mA Type A & Type C-2 module	2536	1/10/100
6792 90	USB Charger 1500mA Type C-1 module	1802	1/5/50

Combi (Socket+USB)

6792 92	Combi twin USB Charger 3.1A Type A with Multistandard Socket - 2 Module	3378	1/5/50
6792 93	Combi twin USB Charger 3.1A Type A and Type C with Multistandard Socket - 2 Module	3720	1/5/50
6792 94	Combi twin USB Charger 3.1A Type C with Multistandard Socket - 2 Module	3720	1/5/50
6792 33	Combi twin USB Charger 3.1A Type A with Euro Socket - 2 Module	2052	1/10/100
6792 34	Combi twin USB Charger 3.1A Type A & Type C with Euro Socket - 2 Module	2462	1/10/100

Loud Speakers

6792 98	Ceiling Loudspeaker 8 Ohms 100mm	2882	1/6
---------	----------------------------------	------	-----

Sound Diffusion

6792 99	Bluetooth Sound Diffusion 2M	5902	1/10/100
---------	------------------------------	------	----------

Rotary Dimmer Universal

6793 04	Rotary LED light dimmer 1M - 50W	2424	1/10/120
---------	----------------------------------	------	----------

Touch Switches

6793 08	Touch Switch 2M 1 way-2 Switch 1000W	3606	1/50
6793 09	Touch Switch 2M 1 way 1440W	3606	1/50
6793 10	Touch Switch 2M 2 way 1000W	4166	1/50

* MRP - Maximum Retail Price Inclusive of all taxes including GST.

■ To be Introduced Shortly

(1) Supplied with white plate

■ Price available on request

Bold Cat.Nos are products normally available with Legrand (India) Stockists. Cat.Nos that are not bold - delivery within 4 - 8 weeks from the date of order. Bold packing quantity is our mandatory packing. Orders to be placed by Legrand (India) Stockist in multiples of the same.

Myrius™ switches - charcoal grey

Cat.Nos	Description	MRP ₹ / Unit	Pack
---------	-------------	--------------------	------

Touch Switches

6793 13	Touch Switch 2M 1 way 3000W	4166	1/50
6793 06	Touch Switch Bell Push 2M 1440W	3606	1/50

Touch Regulator, Curtain & Dimmer

6793 07	Touch Switch - curtain controller 2M	4166	1/50
6793 05	Touch Fan regulator 2M 100W	4166	1/50
6793 15	300W Universal LED Touch scroll dimmer 2M	4124	1/50

Reading Light

6793 16	Reading Light LED 2M	2434	1/10
---------	----------------------	------	------

Accessories

6792 75	Cable outlet 8mm 1M	266	20/200
6792 76	Blanking plate 1M	50	40/400
6792 77	Blanking plate 2M	58	10/100

Mechanisms Charcoal Grey Switches 6A 230V AC

6794 00	6A Switch 1 way 1M	177	20/200
6794 01	6A Switch 2 way 1M	270	20/200
6794 02	6A Switch 1 way 1M with Indicator	296	20/200
6794 03	6A Switch 1 way 1M with light marking	228	20/200
6794 04	6A Switch 1 way 1M with Fan marking	228	20/200

Switches 10A 230V AC

6794 05	10A Switch 1 way 2M	340	10/100
6794 06	10A Switch 2 way 2M	366	10/100
6794 07	10A Intermediate Switch 2M	2112	10/100
6794 08	10A Switch 1 way 2M with Indicator	390	10/100

Switches 16A 230V AC

6794 09	16A Switch 1 way 1M	358	20/200
6794 10	16A Switch 2 way 1M	432	20/200
6794 11	16A Switch 1 way 1M with Indicator	448	20/200

Switches 20A 230V AC

6794 12	20A Switch 1 way 1M	478	20/200
6794 13	20A DP Switch 1 way 2M	748	10/100
6794 14	20A DP Switch 1 way 2M with Indicator	796	10/100
6794 15	20A Switch 2 way 2M	820	10/100

Myrius™ sockets, regulators, hospitality function

Cat.Nos	Description	MRP ₹ / Unit	Pack
---------	-------------	--------------------	------

Switches 25A 230V AC

6794 16	25A SP 1 way with Indicator 1M	548	20/200
---------	--------------------------------	-----	--------

Switches 32A 230V AC

6794 17	32A DP Switch 2M with Indicator	1224	10/100
---------	---------------------------------	------	--------

Push button 6A 230V AC

6794 18	6A Push Button SP 1 way 1M	318	20/200
6794 19	6A Push Button 1way 1M with Indicator	396	20/200
6794 20	6A Bell Push 1 way 1M	296	20/200
6794 21	6A Bell Push 1 way 1M with Indicator	396	20/200
6794 22	6A Bell Push 1 way 2M	460	10/100
6794 23	6A Bell Push 1 way 2M with Indicator	548	10/100

Sockets 240V AC

6794 26	16A 3 Pin Switched Socket 3M	1380	5/50
6794 29	6/16A ISI Socket 3M	650	5/50
6794 30	6/16A ISI Socket 2M	552	10/100
6794 32	25A Socket 2M	676	10/100
6794 35	6A 3-Pin ISI Socket 2 module	270	1/20/200

Dimmers and Fan Regulators

6794 36	Rotary Dimmer 400W 1M	1340	5/50
6794 37	Rotary Light Dimmer 500W 2M	2034	10/100
6794 39	Fan Regulator 100W ISI 1M	1046	5/50
6794 40	Fan Regulator 100W 360 Degree ISI 2M	1186	10/100
6794 41	Fan Regulator 120W 360 Degree ISI 2M	1306	10/100
6794 42	Fan Regulator 70W ISI 2M	1262	1/10/100
6794 31	Fan regulator 8 step 100w 2 module	1084	1/10/100

Skirting Light

6794 48	Skirting Light with Warm White LED 3M	1014	5/25
---------	---------------------------------------	------	------

* MRP - Maximum Retail Price Inclusive of all taxes including GST.
■ Price available on request

Bold Cat.Nos are products normally available with Legrand (India) Stockists. Cat.Nos that are not bold - delivery within 4 - 8 weeks from the date of order. Bold packing quantity is our mandatory packing. Orders to be placed by Legrand (India) Stockist in multiples of the same.

Myrius™

hospitality functions, sockets,
electronic function

Cat.Nos	Description	MRP ₹ / Unit	Pack
---------	-------------	--------------------	------

Bell call indicator

6794 49	Bell Call Indicator 1M	1360	20/200
---------	------------------------	------	--------

Buzzer

6794 50	Buzzer 230V 1M	1448	20/200
---------	----------------	------	--------

Remote Unit

6794 52	Remote control unit for light and fan 4M	8086	1/5/20
6793 03	Remote control hand unit	622	1/5/30

Hospitality Function Hotel Keycard Switch

6794 53	16A Hotel key FOB Switch	4852	1/10
6792 55	Credit card size Key FOB	184	10/100

Hotel "DND and MMR" Functions

6794 54	DND & MMR INDICATOR 1M + 1M BELL PUSH	2064	10/100
6794 55	DND & MMR (INSIDE)	1362	10/100

Shaver socket

6794 58	Shaver Skt 120/240vac Monoblock With Plate 2m	3578	1/16
6794 59	Shaver Skt 120/230vac Monoblock With Plate 4m	5674	1/5/20

Sockets and Connectors

TV Sockets

6794 60	T.V co-axial Socket	286	20/200
---------	---------------------	-----	--------

Data & Voice

6794 62	RJ11 Telephone	274	20/200
6794 63	Double RJ11 Telephone	420	20/200
6794 64	RJ 45 UTP cat 5 tooless with shutter 1M	604	20/200
6794 65	RJ 45 UTP cat 6 tooless with shutter 1M	892	20/200
6794 66	RJ 45 UTP cat 6 tooless with shutter 2M	914	10/200

Audio-Video Sockets

6794 67	Preterminated AV connector 1M	2112	1/10
6794 68	Preterminated HDMI socket 1M	2590	1/10
6794 69	Preterminated projector connector 1M	2590	1/10

Myrius™

electronic function, plate with frame

Cat.Nos	Description	MRP ₹ / Unit	Pack
---------	-------------	--------------------	------

Sound (Volume Controller)

6794 70	Volume Controller 2M	1598	1/10/100
---------	----------------------	------	----------

Protectors and Accessories Motor Starter

6794 71	16A Motor Starter 2M	864	1/10/100
6794 72	25A Motor Starter 2M	886	1/10/100

Electronic Function

USB chargers (IS13252 (Part 1) / IEC 60950-1)

6794 88	USB Charger 1500mA Type A-1 module	1882	1/5/100
6794 89	Double USB Charger 3000mA Type A & Type C-2 module	2918	1/10/100
6794 90	USB Charger 1500mA Type C-1 module	2072	1/5/100

Combi (Socket + USB)

6794 92	Combi twin USB Charger 3.1A Type A with Multistandard Socket - 2 Module	3884	1/5/50
6794 93	Combi twin USB Charger 3.1A Type A and Type C with Multistandard Socket - 2 Module	4274	1/5/50
6794 94	Combi twin USB Charger 3.1A Type C with Multistandard Socket - 2 Module	4274	1/5/50
6794 33	Combi twin USB Charger 3.1A Type A with Euro Socket - 2 Module	2428	1/10/100
6794 34	Combi twin USB Charger 3.1A Type A & Type C with Euro Socket - 2 Module	2830	1/10/100

Sound Receiver

6794 97	Bluetooth sound diffusion 2M	6790	1/10/100
---------	------------------------------	------	----------

Rotary Dimmer Universal

6794 98	Rotary LED Light Dimmer 1M-50W	2762	1/10/120
---------	--------------------------------	------	----------

Accessories

6794 75	Cable outlet 8mm 1M	310	20/200
6794 76	Blanking Plate 1M	54	40/400

Mechanism Antibacterial Classic White Switches 6A 230VAC

6793 20	6A SW 1 Way 1m WH Anti-Bacterial	208	0/20/200
6793 21	6A SW 2 Way 1m WH Anti-Bacterial	288	0/20/200
6793 24	6A Bell Push 1m WH Anti-Bact	328	0/20/200

* MRP - Maximum Retail Price Inclusive of all taxes including GST.

■ To be Introduced Shortly

(1) Supplied with white plate

■ Price available on request

Bold Cat.Nos are products normally available with Legrand (India) Stockists. Cat.Nos that are not bold - delivery within 4 - 8 weeks from the date of order. Bold packing quantity is our mandatory packing. Orders to be placed by Legrand (India) Stockist in multiples of the same.

Myrius™ mechanism antibacterial classic white

Cat.Nos	Description	MRP* ₹ / Unit	Pack
---------	-------------	------------------	------

Switches 16A 230VAC

6793 22	16A SW 1 Way 1m WH	388	0/20/200
6793 23	16A SW 2 Way 1m WH	448	0/20/200

Sockets 240V AC

6793 28	6/16A - ISI - Socket 2 module	644	10/100
6793 29	6/16A - ISI - Socket 3 module	692	5/50
6792 38	6A 3-Pin ISI Socket 2 module	300	1/20/200

Fan Regulators

6793 25	Fan Regulator 120W 360 degree 2M White	1386	10/100
---------	--	------	--------

TV Sockets

6793 30	T.V. Socket 1M White	286	20/200
---------	----------------------	-----	--------

Data & Voice

6793 31	RJ11 Telephone Socket 1M	286	20/200
6793 32	RJ45 cat 6 UTP 1M	944	20/200

Accessories

6793 33	Blanking plate 1M	50	40/400
---------	-------------------	----	--------

Plate Frame Plate Frame White

6795 01	Plate+frame 1M	190	20/200
6795 02	Plate+frame 2M	198	20/200
6795 03	Plate+frame 3M	210	10/100
6795 04	Plate+frame 4M	234	10/100
6795 06	Plate+frame 6M	406	5/50
6795 08	Plate+frame 8M	444	5/50
6795 09	Plate+frame 2x4M	564	5/25
6795 10	Plate+frame 9M	596	5/50
6795 12	Plate+frame 12M	674	10
6795 16	Plate+frame 16M	786	10
6795 18	Plate+frame 18M	900	10

Plate Frame Ice White

6795 21	Plate+frame 1M	260	1/5/30
6795 22	Plate+frame 2M	276	1/5/30
6795 23	Plate+frame 3M	292	1/20
6795 24	Plate+frame 4M	314	1/20
6795 26	Plate+frame 6M	564	1/10
6795 28	Plate+frame 8M	616	1/10
6795 29	Plate+frame 2x4M	772	1/5
6795 32	Plate+frame 12M	934	1/5
6795 36	Plate+frame 16M	1090	1/5
6795 38	Plate+frame 18M	1250	1/5

Myrius™ cover plates

Cat.Nos	Description	MRP* ₹ / Unit	Pack
---------	-------------	------------------	------

Plate Frame Ice Black

6795 41	Plate+frame 1M	260	1/5/30
6795 42	Plate+frame 2M	276	1/5/30
6795 43	Plate+frame 3M	292	1/20
6795 44	Plate+frame 4M	314	1/20
6795 46	Plate+frame 6M	564	1/10
6795 48	Plate+frame 8M	616	1/10
6795 49	Plate+frame 2x4M	772	1/5
6795 52	Plate+frame 12M	934	1/5
6795 56	Plate+frame 16M	1090	1/5
6795 58	Plate+frame 18M	1250	1/5

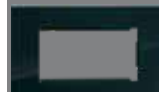

6795 44

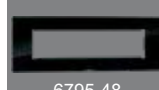

6795 48



6795 56

NEW!

Plate Frame CHARCOAL GREY

6797 01	Plate+Frame 1M	230	1/20/200
6797 02	Plate+Frame 2M	240	1/20/200
6797 03	Plate+Frame 3M	258	1/10/100
6797 04	Plate+Frame 4M	282	1/10/100
6797 06	Plate+Frame 6M	496	1/5/50
6797 08	Plate+Frame 8M	544	1/5/50
6797 09	Plate+Frame 2x4M	688	1/5/25
6797 10	Plate+Frame 9M	740	1/5/50
6797 12	Plate+Frame 12M	824	1/10
6797 16	Plate+Frame 16M	958	1/10
6797 18	Plate+Frame 18M	1100	1/10

Plate Frame Pearl Champagne

6795 61	Plate+frame 1M	356	1/5/30
6795 62	Plate+frame 2M	374	1/5/30
6795 63	Plate+frame 3M	398	1/20
6795 64	Plate+frame 4M	432	1/20
6795 66	Plate+frame 6M	772	1/10
6795 68	Plate+frame 8M	842	1/10
6795 69	Plate+frame 2x4M	1056	1/5
6795 72	Plate+frame 12M	1276	1/5
6795 76	Plate+frame 16M	1484	1/5
6795 78	Plate+frame 18M	1708	1/5



6795 62



6795 64

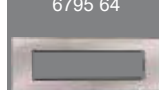

6795 68



6795 72

* MRP - Maximum Retail Price Inclusive of all taxes including GST.

Red Cat.Nos - new products

■ Price available on request.

Bold Cat.Nos are products normally available with Legrand (India) Stockists. Cat.Nos that are not bold - delivery within 4 - 8 weeks from the date of order. Bold packing quantity is our mandatory packing. Orders to be placed by Legrand (India) Stockist in multiples of the same.

Myrius™ cover plates

Cat.Nos	Description	MRP ₹ / Unit	Pack
Plate Frame Sonic Silver			
6795 81	Plate+frame 1M	356	1/5/30
6795 82	Plate+frame 2M	374	1/5/30
6795 83	Plate+frame 3M	398	1/20
6795 84	Plate+frame 4M	432	1/20
6795 86	Plate+frame 6M	772	1/10
6795 88	Plate+frame 8M	842	1/10
6795 89	Plate+frame 2x4M	1056	1/5
6795 92	Plate+frame 12M	1276	1/5
6795 96	Plate+frame 16M	1484	1/5
6795 98	Plate+frame 18M	1708	1/5
Plate Frame Dark Fade			
6796 01	Plate+frame 1M	356	1/5/30
6796 02	Plate+frame 2M	374	1/5/30
6796 03	Plate+frame 3M	398	1/20
6796 04	Plate+frame 4M	432	1/20
6796 06	Plate+frame 6M	772	1/10
6796 08	Plate+frame 8M	842	1/10
6796 09	Plate+frame 2x4M	1056	1/5
6796 12	Plate+frame 12M	1276	1/5
6796 16	Plate+frame 16M	1484	1/5
6796 18	Plate+frame 18M	1708	1/5
Plate Frame Interlude			
6796 21	Plate+frame 1M	468	1/5/30
6796 22	Plate+frame 2M	492	1/5/30
6796 23	Plate+frame 3M	526	1/20
6796 24	Plate+frame 4M	570	1/20
6796 26	Plate+frame 6M	1020	1/10
6796 28	Plate+frame 8M	1110	1/10
6796 29	Plate+frame 2x4M	1392	1/5
6796 32	Plate+frame 12M	1680	1/5
6796 36	Plate+frame 16M	1964	1/5
6796 38	Plate+frame 18M	2250	1/5

Myrius™ cover plates

Cat.Nos	Description	MRP ₹ / Unit	Pack
Plate Frame Trinity			
6796 41	Plate+frame 1M	468	1/5/30
6796 42	Plate+frame 2M	492	1/5/30
6796 43	Plate+frame 3M	526	1/20
6796 44	Plate+frame 4M	570	1/20
6796 46	Plate+frame 6M	1020	1/10
6796 48	Plate+frame 8M	1110	1/10
6796 49	Plate+frame 2x4M	1392	1/5
6796 52	Plate+frame 12M	1680	1/5
6796 56	Plate+frame 16M	1964	1/5
6796 58	Plate+frame 18M	2250	1/5
Plate Frame Luminar			
6796 61	Plate+frame 1M	468	1/5/30
6796 62	Plate+frame 2M	492	1/5/30
6796 63	Plate+frame 3M	526	1/20
6796 64	Plate+frame 4M	570	1/20
6796 66	Plate+frame 6M	1020	1/10
6796 68	Plate+frame 8M	1110	1/10
6796 69	Plate+frame 2x4M	1392	1/5
6796 72	Plate+frame 12M	1680	1/5
6796 76	Plate+frame 16M	1964	1/5
6796 78	Plate+frame 18M	2250	1/5
Plate Frame Stellar			
6796 81	Plate+frame 1M	468	1/5/30
6796 82	Plate+frame 2M	492	1/5/30
6796 83	Plate+frame 3M	526	1/20
6796 84	Plate+frame 4M	570	1/20
6796 86	Plate+frame 6M	1020	1/10
6796 88	Plate+frame 8M	1110	1/10
6796 89	Plate+frame 2x4M	1392	1/5
6796 92	Plate+frame 12M	1680	1/5
6796 96	Plate+frame 16M	1964	1/5
6796 98	Plate+frame 18M	2250	1/5

* MRP - Maximum Retail Price Inclusive of all taxes including GST.

■ To be Introduced Shortly

■ Red Cat.Nos - new products

(1) Supplied with white plate

■ Price available on request

Note: For MRP of mounting boxes please refer main pricelist.

Myrius™ cover plates

Cat.Nos	Description	MRP ₹ / Unit	Pack
Plate Frame Antibacterial			
6793 41	Plate+frame 1M	214	20/200
6793 42	Plate+frame 2M	236	20/200
6793 43	Plate+frame 3M	266	10/100
6793 44	Plate+frame 4M	284	10/100
6793 46	Plate+frame 6M	462	5/50
6793 48	Plate+frame 8M	546	5/50
6793 49	Plate+frame 2x4M	680	5/25
6793 50	Plate+frame 9M	706	5/50
6793 52	Plate+frame 12M	778	10
6793 56	Plate+frame 16M	924	10
6793 58	Plate+frame 18M	1028	10

Myrius™ mounting boxes

Cat.Nos	Description	MRP ₹ / Unit	Pack
Metal flush boxes			
6890 07	Flush box - 1/2M	142	40
6890 08	Flush box - 3M	142	40
6890 09	Flush box - 4M	188	40
6890 10	Flush box - 6M	298	40
6890 42	Flush box - 8M	348	40
6890 31	Flush box - 8M (2 row x 4)	346	20
6890 29	Flush box - 9 module	410	20
6890 11	Flush box - 12/16 (2 row x 6)M	524	10
6890 12	Flush box - 18M	658	10
Plastic surface boxes			
6733 02	Surface box - 1/2M	90	10/50
6733 03	Surface box - 3M	104	5/35
6733 04	Surface box - 4M	122	5/25
6733 06	Surface box - 6M	158	1/10
6733 08	Surface box - 8M	236	1/5
6733 05	Surface box - 8 (2 row x 4)M	224	1/5
Metal surface boxes			
6890 21	Surface Box - 12/16 (2x 6)M	558	1/6
6890 22	Surface Box - 18M	584	1/4

* MRP - Maximum Retail Price Inclusive of all taxes including GST.
 * To be Introduced Shortly
 Red Cat.Nos - new products
 (1) Supplied with white plate
 ■ Price available on request

Bold Cat.Nos are products normally available with Legrand (India) Stockists.
 Cat.Nos that are not bold - delivery within 4 - 8 weeks from the date of order.
 Bold packing quantity is our mandatory packing. Orders to be placed by
 Legrand (India) Stockist in multiples of the same.

Myrius™

INSPIRED BY YOUR
HEALTH-FIRST MANTRA

You prioritize your family's health, hygiene and wellness more than anything else. Inspired, we've created anti-bacterial plates infused with silver ions, which do not let bacteria grow on the surface of Switches and Plates and Accessories throughout its lifespan. One less reason to worry about germs being passed on at home. Live the advantage of a healthy home



ANTI-BACTERIAL RANGE



Myrius™ IoT

INSPIRED BY TOUCH,
SWIPE AND YOUR
VOICE.

Be it controlling operations of lights or curtains remotely or controlling power outlets or viewing energy consumption details – we've got your back in multiple ways that you love. Control functions via voice commands used in combination with multiple ways. You can still use it in the traditional way via switches on wall. Also even by simply swiping on the Home+Control Smartphone app by Legrand.



Scan to know more about
the product.

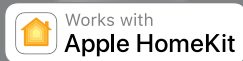

Home +
Control App

Control with:

TOUCH | SWIPE | TALK

Myrius™

IoT

SMART SOLUTIONS
FOR YOUR SMART
NEED.

The Myrius IoT range has been meticulously crafted by us for you and your family's connected, real-time, smart living. Each product combines Legrand's design calibre and the intelligence of the Internet of Things, which brings convenience of different levels to you. Solutions and devices with the power to communicate with each other and complete tasks, supervise scenarios or monitor and give you crucial updates.



**WIRELESS 4
SCENARIO
CONTROL - 2M**



**SWITCH DIMMER
WITH
NEUTRAL - 1M**



**WIRELESS SWITCH
2G - 2M**



**IN WALL WIRELESS
SWITCH - 1M**



Scan to know more about
the product.

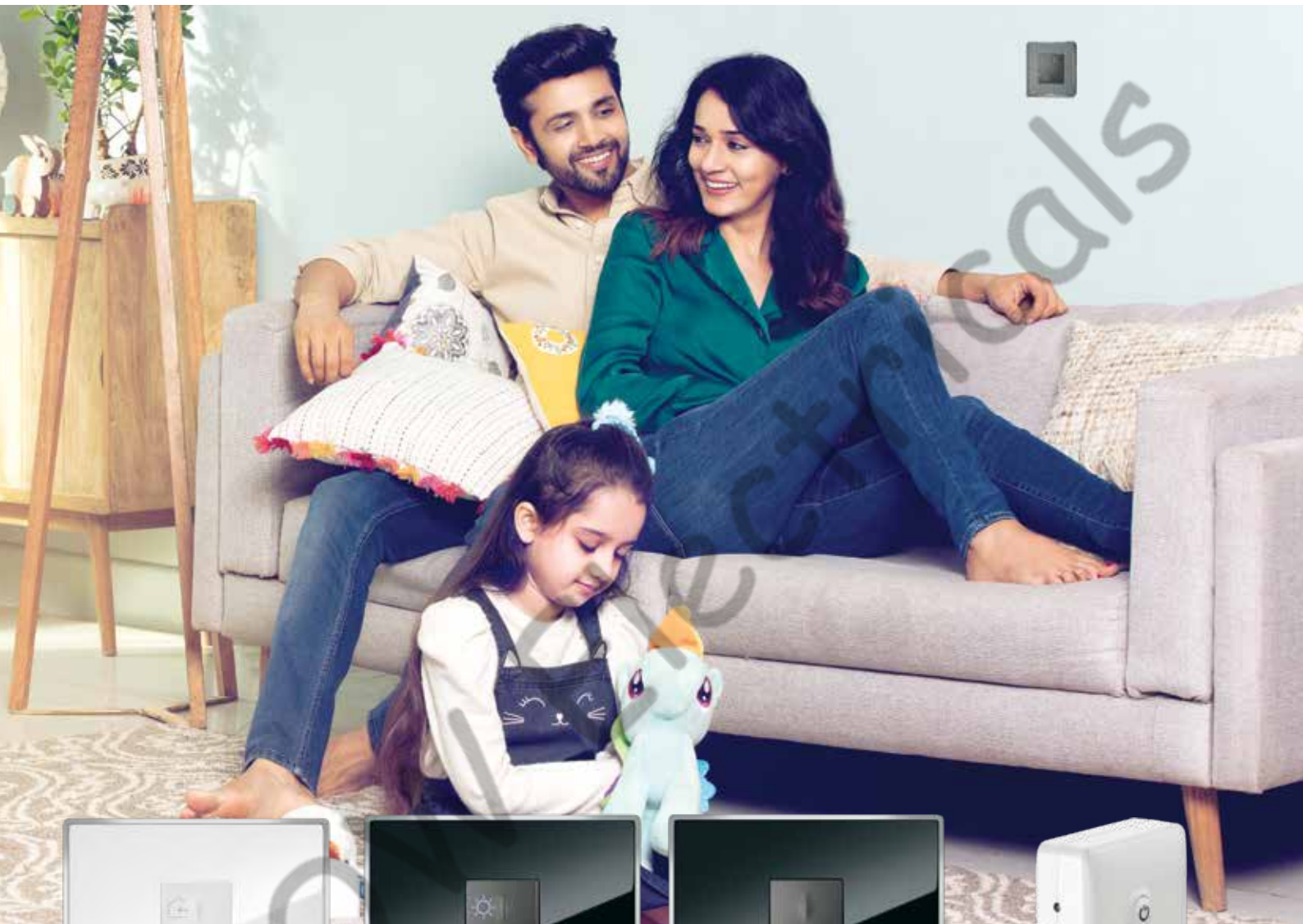

**IN WALL MASTER
HOME
IN/AWAY - 1M**



**IN WALL MASTER
WAKE UP/SLEEP -
1M**



**IN WALL WIRELESS
SHUTTER SWITCH
- 1M**



**16A SMART MOBILE
PLUG**

Myrius™ connected homes - white mechanism

Cat.Nos	Description	MRP* ₹ / Unit	Pack
---------	-------------	------------------	------

Connected light Switches

6793 59	Switch with neutral, wired, 1 module	8702	1/5/50
6793 60	Switch without neutral, with dimmer option, wired, 2 modules	11450	1/5/50
6793 70	Switch dimmer with neutral 150W, 1 module	6956	1/5/30
6793 71	Switch dimmer with neutral, wired, 2 modules	11360	1/5/30

Connected Outlets

6793 67	Connected socket outlet module - 16A - 240VA - 3680 W, 1 module	9022	1/5/50
---------	---	------	--------

Smart Plug

6793 90	6A Smart mobile plug	8450	5/20
6793 91	16A Smart mobile plug	9100	5/21

Connected Curtain/Roller Blind Switches

6793 61	Connected curtain/roller blind switch wired, 1 module	9278	1/5/50
---------	---	------	--------

Connected Gateway Pack

6793 66	Connected gateway + Master home away wireless switch wired, 2 module	18950	1/5/20
---------	--	-------	--------

Connected Wireless Controls

6793 62	Wireless light switch	4172	1/5/30
6793 64	Curtain/roller blind wireless switch	4704	1/5/30
6793 73	2G Wireless switch, 2 module	4202	1/5/30

Connected Wireless Scene Switches

6793 63	Home/Away wireless master switch	4462	1/5/30
6793 65	Wake up/Sleep wireless switch	4864	1/5/30
6793 69	Wireless 4 scenario control switch, 2 module	5304	1/5/30

IN Wall Wireless Switch

6793 72	IN wall wireless light switch - 1 module	3650	1/5/30
6793 94	IN Wall wireless shutter switch - 1 module	4208	1/5/30
6793 92	IN Wall Home/Away wireless switch - 1 module	4250	1/5/30
6793 96	IN Wall Wake up/Sleep wireless switch - 1 module	4250	1/5/30

Charcoal Grey Mechanism Connected Light Switches

6793 74	Switch with neutral, wired, 1 module	10010	1/5/50
6793 75	Switch without neutral, with dimmer option, wired, 2 modules	13170	1/5/50
6793 85	Switch dimmer with neutral 150W, 1 module	7998	1/5/30
6793 86	Switch dimmer with neutral, wired, 2 modules	13062	1/5/30

Myrius™ connected homes - charcoal grey mechanism

Cat.Nos	Description	MRP* ₹ / Unit	Pack
---------	-------------	------------------	------

Connected Outlets

6793 82	Connected socket outlet module - 16A - 240VA - 3680 W, 1 module	10376	1/5/50
---------	---	-------	--------

Connected Curtain/Roller blind Switches

6793 76	Connected curtain/roller blind switch wired, 1 module	10672	1/5/50
---------	---	-------	--------

Connected gateway pack

6793 81	Connected gateway + Master home away wireless switch wired, 2 module	21788	1/5/20
---------	--	-------	--------

Connected wireless controls

6793 77	Wireless light switch	4800	1/5/30
6793 79	Curtain/roller blind wireless switch	5080	1/5/30
6793 88	2G Wireless switch, 2 Module	4830	1/5/30

Connected Wireless scene Switches

6793 78	Home/Away wireless master switch	5464	1/5/30
6793 80	Wake up/Sleep wireless switch	5592	1/5/30
6793 84	Wireless 4 scenario control switch, 2 module	6100	1/5/30

Micro module switch

6793 89	Micro module switch with neutral, 300 W	6508	1/5/50
---------	---	------	--------

IN Wall Wireless Switch

6793 87	IN Wall wireless light switch - 1 module	4196	1/5/30
6793 95	IN Wall wireless shutter switch - 1 module	4838	1/5/30
6793 93	IN Wall Home/Away wireless switch - 1 module	4888	1/5/30
6793 97	IN Wall Wake up/Sleep wireless switch - 1 module	4888	1/5/30

COVER PLATES

Plate Frame White

6795 01	PLATE+FRAME 1M	190	0/20/200
6795 02	PLATE+FRAME 2M	198	0/20/200
6795 03	PLATE+FRAME 3M	210	0/10/100
6795 04	PLATE+FRAME 4M	234	0/10/100
6795 06	PLATE+FRAME 6M	406	0/5/50
6795 08	PLATE+FRAME 8M	444	0/5/50
6795 09	PLATE+FRAME 2X4M	564	0/5/25
6795 10	PLATE+FRAME 9M	596	0/5/50
6795 12	PLATE+FRAME 12M	674	0/0/10
6795 16	PLATE+FRAME 16M	786	0/0/10
6795 18	PLATE+FRAME 18M	900	0/0/10

* MRP - Maximum Retail Price Inclusive of all taxes including GST.
■ Price available on request

Bold Cat.Nos are products normally available with Legrand (India) Stockists. Cat.Nos that are not bold - delivery within 4 - 8 weeks from the date of order. Bold packing quantity is our mandatory packing. Orders to be placed by Legrand (India) Stockist in multiples of the same.

Myrius™ cover plates

Cat.Nos	Description	MRP ₹ / Unit	Pack
Plate Frame ICE WHITE			
6795 21	PLATE+FRAME 1M ICE WHITE	260	1/5/30
6795 22	PLATE+FRAME 2M ICE WHITE	276	1/5/30
6795 23	PLATE+FRAME 3M ICE WHITE	292	1/0/20
6795 24	PLATE+FRAME 4M ICE WHITE	314	1/0/20
6795 26	PLATE+FRAME 6M ICE WHITE	564	1/0/10
6795 28	PLATE+FRAME 8M ICE WHITE	616	1/0/10
6795 29	PLATE+FRAME 2X4M ICE WHITE	772	1/0/5
6795 32	PLATE+FRAME 12M ICE WHITE	934	1/0/5
6795 36	PLATE+FRAME 16M ICE WHITE	1090	1/0/5
6795 38	PLATE+FRAME 18M ICE WHITE	1250	1/0/5

Plate Frame ICE BLACK

6795 41	PLATE+FRAME 1M ICE BLACK	260	1/5/30
6795 42	PLATE+FRAME 2M ICE BLACK	276	1/5/30
6795 43	PLATE+FRAME 3M ICE BLACK	292	1/0/20
6795 44	PLATE+FRAME 4M ICE BLACK	314	1/0/20
6795 46	PLATE+FRAME 6M ICE BLACK	564	1/0/10
6795 48	PLATE+FRAME 8M ICE BLACK	616	1/0/10
6795 49	PLATE+FRAME 2X4M ICE BLACK	772	1/0/5
6795 52	PLATE+FRAME 12M ICE BLACK	934	1/0/5
6795 56	PLATE+FRAME 16M ICE BLACK	1090	1/0/5
6795 58	PLATE+FRAME 18M ICE BLACK	1250	1/0/5

Myrius™ cover plates

Cat.Nos	Description	MRP ₹ / Unit	Pack
Plate Frame CHARCOAL GREY			
6797 01	PLATE+FRAME 1M CHARCOAL GREY	230	1/20/200
6797 02	PLATE+FRAME 2M CHARCOAL GREY	240	1/20/200
6797 03	PLATE+FRAME 3M CHARCOAL GREY	258	1/10/100
6797 04	PLATE+FRAME 4M CHARCOAL GREY	282	1/10/100
6797 06	PLATE+FRAME 6M CHARCOAL GREY	496	1/5/50
6797 08	PLATE+FRAME 8M CHARCOAL GREY	544	1/5/50
6797 09	PLATE+FRAME 2X4M CHARCOAL GREY	688	1/5/25
6797 10	PLATE+FRAME 9M CHARCOAL GREY	740	1/5/50
6797 12	PLATE+FRAME 12M CHARCOAL GREY	824	1/10
6797 16	PLATE+FRAME 16M CHARCOAL GREY	958	1/10
6797 18	PLATE+FRAME 18M CHARCOAL GREY	1100	1/10

Plate Frame PEARL CHAMPAGNE

6795 61	PLATE+FRAME 1M PEARL CHAMPAGNE	356	1/5/30
6795 62	PLATE+FRAME 2M PEARL CHAMPAGNE	374	1/5/30
6795 63	PLATE+FRAME 3M PEARL CHAMPAGNE	398	1/0/20
6795 64	PLATE+FRAME 4M PEARL CHAMPAGNE	432	1/0/20
6795 66	PLATE+FRAME 6M PEARL CHAMPAGNE	772	1/0/10
6795 68	PLATE+FRAME 8M PEARL CHAMPAGNE	842	1/0/10
6795 69	PLATE+FRAME 2X4M PEARL CHAMPAGNE	1056	1/0/5
6795 72	PLATE+FRAME 12M PEARL CHAMPAGNE	1276	1/0/5
6795 76	PLATE+FRAME 16M PEARL CHAMPAGNE	1484	1/0/5
6795 78	PLATE+FRAME 18M PEARL CHAMPAGNE	1708	1/0/5

* MRP - Maximum Retail Price Inclusive of all taxes including GST.

■ To be Introduced Shortly

(1) Supplied with white plate

■ Price available on request

Bold Cat.Nos are products normally available with Legrand (India) Stockists. Cat.Nos that are not bold - delivery within 4 - 8 weeks from the date of order. Bold packing quantity is our mandatory packing. Orders to be placed by Legrand (India) Stockist in multiples of the same.

Myrius™ cover plates

Cat.Nos	Description	MRP* ₹ / Unit	Pack
Plate Frame SONIC SILVER			
6795 81	PLATE+FRAME 1M SONIC SILVER	356	1/5/30
6795 82	PLATE+FRAME 2M SONIC SILVER	374	1/5/30
6795 83	PLATE+FRAME 3M SONIC SILVER	398	1/0/20
6795 84	PLATE+FRAME 4M SONIC SILVER	432	1/0/20
6795 86	PLATE+FRAME 6M SONIC SILVER	772	1/0/10
6795 88	PLATE+FRAME 8M SONIC SILVER	842	1/0/10
6795 89	PLATE+FRAME 8M SONIC SILVER	1056	1/0/5
6795 92	PLATE+FRAME 12M SONIC SILVER	1276	1/0/5
6795 96	PLATE+FRAME 16M SONIC SILVER	1484	1/0/5
6795 98	PLATE+FRAME 18M SONIC SILVER	1708	1/0/5

Plate Frame DARK FADE

6796 01	PLATE+FRAME 1M DARK FADE	356	1/5/30
6796 02	PLATE+FRAME 2M DARK FADE	374	1/5/30
6796 03	PLATE+FRAME 3M DARK FADE	398	1/0/20
6796 04	PLATE+FRAME 4M DARK FADE	432	1/0/20

Myrius™ cover plates

Cat.Nos	Description	MRP* ₹ / Unit	Pack
Plate Frame DARK FADE			
6796 06	PLATE+FRAME 6M DARK FADE	772	1/0/10
6796 08	PLATE+FRAME 8M DARK FADE	842	1/0/10
6796 09	PLATE+FRAME 2X4M DARK FADE	1056	1/0/5
6796 12	PLATE+FRAME 12M DARK FADE	1276	1/0/5
6796 16	PLATE+FRAME 16M DARK FADE	1484	1/0/5
6796 18	PLATE+FRAME 18M DARK FADE	1708	1/0/5



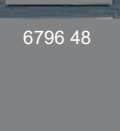

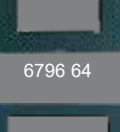



Plate Frame INTERLUDE

6796 21	PLATE+FRAME 1M INTERLUDE	468	1/5/30
6796 22	PLATE+FRAME 2M INTERLUDE	492	1/5/30
6796 23	PLATE+FRAME 3M INTERLUDE	526	1/0/20
6796 24	PLATE+FRAME 4M INTERLUDE	570	1/0/20
6796 26	PLATE+FRAME 6M INTERLUDE	1020	1/0/10
6796 28	PLATE+FRAME 8M INTERLUDE	1110	1/0/10
6796 29	PLATE+FRAME 2X4M INTERLUDE	1392	1/0/5
6796 32	PLATE+FRAME 12M INTERLUDE	1680	1/0/5
6796 36	PLATE+FRAME 16M INTERLUDE	1964	1/0/5
6796 38	PLATE+FRAME 18M INTERLUDE	2250	1/0/5

* MRP - Maximum Retail Price Inclusive of all taxes including GST.
 ■ Price available on request

Bold Cat.Nos are products normally available with Legrand (India) Stockists.
 Cat.Nos that are not bold - delivery within 4 - 8 weeks from the date of order.
 Bold packing quantity is our mandatory packing. Orders to be placed by
 Legrand (India) Stockist in multiples of the same.

Myrius™ cover plates









Cat.Nos	Description	MRP ₹ / Unit	Pack
Plate Frame TRINITY			
 6796 41	PLATE+FRAME 1M TRINITY	468	1/5/30
 6796 42	PLATE+FRAME 2M TRINITY	492	1/5/30
 6796 43	PLATE+FRAME 3M TRINITY	526	1/0/20
 6796 44	PLATE+FRAME 4M TRINITY	570	1/0/20
 6796 46	PLATE+FRAME 6M TRINITY	1020	1/0/10
 6796 48	PLATE+FRAME 8M TRINITY	1110	1/0/10
 6796 49	PLATE+FRAME 2X4M TRINITY	1392	1/0/5
 6796 52	PLATE+FRAME 12M TRINITY	1680	1/0/5
 6796 56	PLATE+FRAME 16M TRINITY	1964	1/0/5
6796 58	PLATE+FRAME 18M TRINITY	2250	1/0/5
Plate Frame LUMINAR			
6796 61	PLATE+FRAME 1M LUMINAR	468	1/5/30
6796 62	PLATE+FRAME 2M LUMINAR	492	1/5/30
6796 63	PLATE+FRAME 3M LUMINAR	526	1/0/20
6796 64	PLATE+FRAME 4M LUMINAR	570	1/0/20
6796 66	PLATE+FRAME 6M LUMINAR	1020	1/0/10
6796 68	PLATE+FRAME 8M LUMINAR	1110	1/0/10
6796 69	PLATE+FRAME 2X4M LUMINAR	1392	1/0/5
6796 72	PLATE+FRAME 12M LUMINAR	1680	1/0/5
6796 76	PLATE+FRAME 16M LUMINAR	1964	1/0/5
6796 78	PLATE+FRAME 18M LUMINAR	2250	1/0/5

* MRP - Maximum Retail Price Inclusive of all taxes including GST.

■ Price available on request

• Suitable only for wireless switch,

Myrius™ cover plates

Cat.Nos	Description	MRP ₹ / Unit	Pack
Plate Frame STELLAR			
 6796 81	PLATE+FRAME 1M STELLAR	468	1/5/30
 6796 82	PLATE+FRAME 2M STELLAR	492	1/5/30
 6796 83	PLATE+FRAME 3M STELLAR	526	1/0/20
 6796 84	PLATE+FRAME 4M STELLAR	570	1/0/20
 6796 86	PLATE+FRAME 6M STELLAR	1020	1/0/10
 6796 88	PLATE+FRAME 8M STELLAR	1110	1/0/10
 6796 89	PLATE+FRAME 2X4M STELLAR	1392	1/0/5
 6796 92	PLATE+FRAME 12M STELLAR	1680	1/0/5
 6796 96	PLATE+FRAME 16M STELLAR	1964	1/0/5
6796 98	PLATE+FRAME 18M STELLAR	2250	1/0/5
cover plates without frame			
Plate without frame*			
6795 05	PLATE 2M SQ WHITE	120	1/5/30
6795 25	PLATE 2M SQ ICE WHITE	258	1/5/30
6795 45	PLATE 2M SQ ICE BLACK	258	1/5/30
6795 65	PLATE 2M SQ PEARL CHAMPAGNE	358	1/5/30
6795 85	PLATE 2M SQ SONIC SILVER	358	1/5/30
6796 05	PLATE 2M SQ DARK FADE	358	1/5/30
6796 25	PLATE 2M SQ INTERLUDE	476	1/5/30
6796 45	PLATE 2M SQ TRINITY	476	1/5/30
6796 65	PLATE 2M SQ LUMINAR	476	1/5/30
6796 85	PLATE 2M SQ STELLAR	476	1/5/30
Accessory			
0648 71	Pack of 3 x 4 extra removable stickers for fixing a wireless control	570	1/25

Bold Cat.Nos are products normally available with Legrand (India) Stockists. Cat.Nos that are not bold - delivery within 4 - 8 weeks from the date of order. Bold packing quantity is our mandatory packing. Orders to be placed by Legrand (India) Stockist in multiples of the same.

Myrius™

REGULAR



The Myrius's range of plates is crafted with unique features & flawless designs, it perfectly defines aestheticism. These minimalistic and flawless designs are available in neutral tones of grainy matte black and glossy white to suit any décor.



Black Beauty

A mystic black shade with a grainy matte finish truly complements any décor.

Snowy White

Its gleaming white shade and a perfect glossy finish creates a soothing décor.



MORE AESTHETICS

Flat, sleek and smooth, Myrius with its curved edges gives it a distinct and appealing look to everyone. Moreover, its minimalistic design makes it look absolutely stunning and desirable. But what makes Myrius truly beautiful is a classic black and white shade that offers an aura of comfort and timelessness.



VSP - Voltage Surge protectors

- Protects electrical devices like laptops, computers, printers and other office equipments from voltage surge
- Blends very well with the modular range of wiring devices



Motor Starter

- Complete protection against overload
- Aesthetically appealing
- For ACs/Geysers etc.



Skirting light

- Fitted into the walls at skirting level
- Provides a dim lighting
- Creates a path light during night
- Uses LEDs that saves energy



Remote control switch for light and fan

- Can control 4 lights & 1 fan
- 10 different speed options for fan
- Night lamp on product panel with manual operation option for all functions

Myrius™

REGULAR



Myrius range of wiring accessories is a classic creation to increase the customer's comfort and improve the work environment. This wide range of innovative products offers solutions for residential, commercial and hospitality projects, thus making it a range that caters to everyone's needs.



Fan regulator



Light Marking



Telephone Socket



AV Connector



RJ 45 Data Socket

Myrius™
Regular
Anti-bacterial



Projector connector



Key Fob Switch



Do not disturb Switch

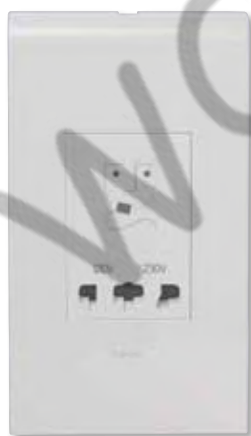

Shaver socket



USB Charger



Modular MCB

Myrius™ Regular mechanisms - white

Cat.Nos	Description	MRP* ₹ / Unit	Pack
---------	-------------	------------------	------

Switches - 6 A - 230 VA

6730 00	6 A switch 1 W - 1 module	152	20/200
6730 01	6 A switch 2 W - 1 module	258	20/200
6730 02	6 A switch 1 W - 1 module with indicator	238	20/200
6730 03	6 A switch 1 W - 1 module with "Light" marking	204	20/200
6730 04	6 A switch 1 W - 1 module with "Fan" marking	212	20/200

Switches - 10 A - 230 VA

6730 05	10 A switch 1 W - 2 module	302	10/100
6730 06	10 A switch 2 W - 2 module	352	10/100
6730 17	10 A intermediate - 2 module	1982	10/100
6730 07	10 A switch 1 W with indicator - 2 module	374	10/100

Switches - 16 A - 230 VA

6730 08	16 A switch 1 W - 1 module	344	20/200
6730 09	16 A switch 2 W - 1 module	398	20/200
6730 10	16 A switch 1 W with indicator - 1 module	418	20/200

Switches - 20 A - 230 VA

6730 11	20 A 1 W switch - 1 module	452	20/200
6730 12	20 A DP 1 W switch - 2 module	686	10/100
6730 13	20 A DP 1 W switch with indicator - 2 module	730	10/100
6730 14	20 A 2 W switch - 2 module	762	10/100

Switches - 25 A - 230 VA

6730 15	25 A SP 1 W switch with indicator - 1 module	504	20/200
---------	--	-----	--------

Switches - 32 A - 230 VA

6730 16	32 A DP switch with indicator - 2 module	1182	10/100
---------	--	------	--------

Myrius™ Regular mechanisms - white

Cat.Nos	Description	MRP* ₹ / Unit	Pack
---------	-------------	------------------	------

Push buttons

6730 18	6 A push button SP - 1 module	294	20/200
6730 19	6 A push button SP with indicator - 1 module	380	20/200
6730 20	6 A bell push - 1 module	284	20/200
6730 21	6 A bell push with indicator - 1 module	374	20/200
6730 22	6 A bell push - 2 module	430	10/100
6730 23	6 A bell push with indicator - 2 module	504	10/100

Accessories for switches with indicator

6732 44	Lamp for switches / push buttons	72	5/50
---------	----------------------------------	----	------

Socket - 230 VA

6730 42	16 A 3 Pin switched socket - 3 module	1302	5/50
6730 83	6/16A socket - ISI	620	5/50
6730 45	6/16A socket - ISI	518	10/100
6730 47	25 A socket - 2 module	642	10/100
6731 86	6A 3 Pin ISI socket - 2 module	254	1/20/200

Dimmer & regulator

6730 24	Rotary dimmer 400 W 1M	1264	1/5/50
6730 25	Rotary dimmer 650 W 2M	2658	1/10
6730 26	Compact fluorescent	4152	1/10
6730 27	Fan step regulator 100 W ISI 1M	974	1/5/50
6730 29	Fan step regulator 100 W ISI 2M	1120	1/10/100
6730 28	Fan step regulator 120 W ISI 2M	1206	1/10/100
6730 77	Fan step regulator or energy saving fans	1180	1/10/100

Emergency light

0785 12	Emergency light unit 2 module	6186	1/1
---------	-------------------------------	------	-----

Indicators

0785 73	Triangular bulkhead - Blue - 2 module	328	1/1
0785 71	Triangular bulkhead -	328	1/1
0785 72	Triangular bulkhead - green - 2 module	362	1/1
0785 70	Triangular bulkhead -	362	1/1

Skirting light

6730 36	Skirting light with white LED - 3 module	974	1/5/25
---------	--	-----	--------

* MRP - Maximum Retail Price Inclusive of all taxes including GST.

Bold Cat.Nos are products normally available with Legrand (India) Stockists. Cat.Nos that are not bold - delivery within 4 - 8 weeks from the date of order. Bold packing quantity is our mandatory packing. Orders to be placed by Legrand (India) Stockist in multiples of the same.

Myrius™ Regular

mechanisms - white

Cat.Nos	Description	MRP* ₹ / Unit	Pack
Bell indicator			
6730 33	Bell indicator - 240 VA - 1 module	1362	20/200
Buzzer			
6730 34	Buzzer - 230 VA - 1 module	1340	20/200
Remote unit			
6730 73	Remote control switch - 4 module	9870	1/5/20
Hospitality functions			
Key FOB switch			
6730 37	15 A key card switch monobloc with plate - 2 M	4576	1/10
6732 37	15 A key card switch monobloc with new plate - 2M White	5270	1/10
6730 38	Only key fob for switch Cat.Nos 6730 37 & 6732 37	218	1/10/100
"Do Not Distrub" and MMR control unit			
6730 39	External unit - 1+1 module	1950	10/100
6730 40	Internal unit - 1+1 module	1302	10/100
Shaver socket			
6730 49	Shaver Socket 230 V / 120 - 230 V monobloc with plate - 4 M	5806	1/5/20
6730 79	Shaver Socket 230 V / 120 - 230 V monobloc with new plate - 4 M White	6090	1/5
Sockets and connectors			
TV socket			
6730 50	TV socket - 1 module	248	20/200
Data & voice			
6730 52	RJ-11 telephone socket with transparent shutter 1 module	246	20/200
6730 53	RJ-11 double telephone socket with shutter 1 module	380	20/200
6730 54	UTP cat 5e information outlets toolless system 1 module	534	20/200
6730 55	UTP cat 6 - 1 module	836	20/200
6730 56	UTP cat 6 - 2 module	806	10/100
USB chargers (IS13252 (Part 1) / IEC 60950-1)			
6731 62	*USB charger 1M 1500mA	1820	10/100
6731 78	Double USB charger 2M 2400mA	2550	1/10/100

* MRP - Maximum Retail Price Inclusive of all taxes including GST.
 # To be Introduced Shortly

Myrius™ Regular

mechanisms - white

Cat.Nos	Description	MRP* ₹ / Unit	Pack
Combi (USB + Socket)			
6731 84	Combi Twin USB 3.1A Euro Socket type A-2 module	2174	1/10/100
6731 85	Combi Twin USB 3.1A Euro Socket type A & type C-2 module	2610	1/10/100
Audio & video connector			
6730 57	3 x female RCA 1 module 1 module	3412	1/10
Sound (Volume controller)			
6730 63	Suitable for 8 Ohms, 3W (RNS) speaker - 2	1630	1/10/100
Protectors and accessories			
Motor starter			
6730 30	16A motor starter 2 module	798	1/10/100
6730 31	25A motor starter 2 module	818	1/10/100
Modular MCB (IS : 60898-1:2002)			
6730 64	16A MCB SP 1M C curve	474	1/10/100
6730 65	20A MCB SP 1M C curve	474	1/10/100
6732 05	25A MCB SP 1M C curve	474	1/10/100
6732 07	32A MCB SP 1M C curve	474	1/10/100
RCBO			
6730 78	Single pole + Neutral - 30 mA, 16 A - 230 VA 2 module	10652	1/1
Accessories			
6730 60	Cable outlet - 8 mm 1 module	306	20/200
6730 61	Blanking plate - 1 module	64	20/200
6730 62	Blanking plate - 2 module	76	10/100
0802 90	Panel mounting support 1 module	252	10/200
0802 91	Panel mounting support 2 module	264	10/200
Myrius Regular antibacterial switches & accessories - white			
6730 84	6 A switch 1 W - 1 module	236	20/200
6730 85	6 A switch 2 W - 1 module	312	20/200
6730 86	6 A bell push - 1 module	350	20/200
6730 89	16 A switch 1 way - 1 module	418	20/200
6730 90	16 A switch 2 way-1 module	482	20/200
6730 92	Fan regulator 120 W - ISI 2 module	1520	1/10/100
6730 95	6/16A ISI socket - 3 module	748	5/50
6731 87	6A 3-Pin ISI socket - 2 module	318	1/20/200
0787 00	Equipotential socket 1 module antibacterial	1898	1/10
6730 98	T.V. socket - 1 module	308	20/200

Bold Cat.Nos are products normally available with Legrand (India) Stockists. Cat.Nos that are not bold - delivery within 4 - 8 weeks from the date of order. Bold packing quantity is our mandatory packing. Orders to be placed by Legrand (India) Stockist in multiples of the same.

Myrius™ Regular mechanisms - white

Cat.Nos	Description	MRP* ₹ / Unit	Pack
---------	-------------	---------------------	------

Myrius regular antibacterial Switches white

6730 99	RJ -11 telephone socket - 1 module	308	20/200
6730 81	RJ-45 Cat 6 UTP - 1 module	976	20/200
6730 82	Blanking plate - 1 module	56	20/200
6732 45	1 module plate + frame 1 module	230	20/200
6732 46	2 module plate + frame 2 module	260	20/200

Myrius regular antibacterial Accessories white

6732 47	3 module plate + frame 3 module	292	10/100
6732 48	4 module plate + frame 4 module	316	10/100
6732 49	8 module plate + frame (horizontal) 8 module	606	5/50
6732 50	8 module plate + frame (4x2) 8 module	764	5/25
6732 52	16 module plate + frame 16 module	1060	1/10

Switches – 6 A - 230 VA

6731 00	6 A switch 1 W 1 module	192	20/200
6731 01	6 A switch 2 W 1 module	294	20/200
6731 02	6 A switch 1 W with indicator - 1 module	324	20/200
6731 03	6 A switch 1 W with "Light" marking 1 module	248	20/200
6731 04	6 A switch 1 W with "Fan" marking 1 module	248	20/200

Switches – 10 A - 230 VA

6731 05	10 A switch 1 W 2 module	370	10/100
6731 06	10 A switch 2 W 2 module	398	10/100
6731 17	10 A intermediate switch 2 module	2286	10/100
6731 07	10 A switch 1 W with indicator - 2 module	426	10/100

Switches – 16 A - 230 VA

6731 08	16 A switch 1 way 1 module	386	20/200
6731 09	16 A switch 2 way 1 module	464	20/200
6731 10	16 A switch 1 way with indicator - 1 module	482	20/200

* MRP - Maximum Retail Price Inclusive of all taxes including GST.

Myrius™ REGULAR ANTI-BACTERIAL

MORE FOR YOUR WELLNESS



Myrius anti-bacterial products offer anti-bacterial protection. The composition of the product contain Ag+ ions that eliminates the proliferation of bacteria on contact with the surface of the product. It has a smooth and straight design that facilitates in reducing the dust accumulation. It is self disinfecting throughout its lifespan.

- Extremely useful in agri-food premises, healthcare environments & premises with high risk in terms of people's fragility.
- Special protection for the health and hygiene market in the form of an equipotential socket for earthing devices, application to connection of hospital beds and trolleys to medical apparatus to avoid all risk of potential difference during the medical care.



Scan to know more about
the product.

Myrius™ Regular mechanisms - black

Cat.Nos	Description	MRP* ₹ / Unit	Pack
---------	-------------	------------------	------

Switches – 20 A - 230 VA

6731 11	20 A 1 W switch 1 module	518	20/200
6731 12	20 A DP 1 W switch 2 module	812	10/100
6731 13	20 A DP 1 W switch with indicator - 2 module	858	10/100
6731 14	20 A 2 W switch 2 module	890	10/100

Switches – 25 A - 230 VA

6731 15	25 A SP 1 W switch with indicator - 1 module	592	20/200
---------	---	-----	--------

Switches – 32 A - 230 VA

6731 16	32 A DP switch with indicator - 2 module	1368	10/100
---------	--	------	--------

Push buttons

6731 18	6 A push button SP 1 module	340	20/200
6731 19	6 A push button SP with indicator - 1 module	432	20/200
6731 20	6 A bell push - 1 module	324	20/200
6731 21	6 A bell push with indicator - 1 module	432	20/200
6731 22	6 A bell push 2 module	498	10/100
6731 23	6 A bell push with indicator - 2 module	582	10/100

Accessories for switches with indicator

6732 44	Lamp for switches / push buttons	72	5/50
---------	-------------------------------------	----	------

Socket - black

6731 42	16 A 3 pin switched socket - 3 module	1514	5/50
6731 83	6/16A - ISI - socket 3 module	718	5/50
6731 45	6/16A - ISI - socket 2 module	606	10/100
6731 47	25 A socket - 2 module	744	10/100
6721 03	6A 3 Pin ISI socket - 2 module	288	1/20/200

Socket - red

6730 48	16 A switched socket 3 module	1342	5/50
---------	----------------------------------	------	------

Dimmers & regulators

6731 24	Rotary dimmer 400 W 1 module	1450	1/5/50
6731 25	Rotary dimmer 650 W 3 module	3068	1/10
6731 27	Fan step regulator 100 W ISI 1 module	1148	1/5/50

Myrius™ Regular mechanisms - black

Cat.Nos	Description	MRP* ₹ / Unit	Pack
---------	-------------	------------------	------

Dimmers & regulators

6731 29	Fan step regulator 100 W ISI 2 module	1300	1/10/100
6731 28	Fan step regulator 120 W ISI 2 module	1428	1/10/100
6731 77	Fan step regulator - 2 module for energy saving fans	1378	1/10/100

Skirting light

6731 36	Skirting light with white LED - 3 module	1124	1/5/25
---------	---	------	--------

Bell indicator

6731 33	Bell Indicator- 240 VA 1 module	1616	20/200
---------	------------------------------------	------	--------

Buzzer

6731 34	Buzzer - 230 VA sound level 72dB at 1 meter distance 1 module	1568	20/200
---------	---	------	--------

Remote unit

6731 73	Remote control switch 4 module	11456	1/5/20
---------	-----------------------------------	-------	--------

Hospitality functions

Key FOB switch

6731 37	15 A key card switch with timedelay 30 sec. monobloc with plate - 2 M	5254	1/10
6732 67	15 A key card switch monobloc with new plate - 2 M Black	6132	1/10
6730 38	Only key fob for switch Cat.No 6731 37 & 6732 67	218	1/10/100

"Do Not Disturb" and MMR control unit

6731 39	External unit - 1+1 module	2236	10/100
6731 40	Internal unit - 1+1 module	1494	10/100

Shaver socket

6731 49	Shaver socket 220/240 V - 50/60 Hz monobloc with plate - 4 M	6368	1/5/20
6731 79	Shaver socket 230 V / 120 - 230 V monobloc with new plate - 4 M Black	6700	1/5

TV socket

6731 50	TV socket - 1 module	308	20/200
---------	----------------------	-----	--------

Data & voice

6731 52	RJ-11 telephone socket with transparent shutter 1 module	294	20/200
6731 53	RJ-11 double telephone socket with shutter 1 module	452	20/200

* MRP - Maximum Retail Price Inclusive of all taxes including GST.

Bold Cat.Nos are products normally available with Legrand (India) Stockists. Cat.Nos that are not bold - delivery within 4 - 8 weeks from the date of order. Bold packing quantity is our mandatory packing. Orders to be placed by Legrand (India) Stockist in multiples of the same.

Myrius™ Regular mechanisms - black

Cat.Nos	Description	MRP* ₹ / Unit	Pack
---------	-------------	------------------	------

Data & voice

6731 54	UTP cat 5e RJ 45 information outlets 1 module	588	20/200
6731 55	UTP cat 6 - 1 module	896	20/200
6731 56	UTP cat 6 - 2 module	904	10/100

USB chargers (IS13252 (Part 1) / IEC 60950-1)

6731 72	USB Charger 1500mA Type A-1 module	2096	10/100
6732 78	Double USB Charger 2400mA Type A - 2 module	2932	1/10/100

Combi (USB + Socket)

6721 01	Combi Twin USB 3.1A Type A with Euro Socket- 2 module	2500	1/10/100
6721 02	Combi Twin USB 3.1A Type A and Type C with Euro Socket - 2 Module	3002	1/10/100

Connectors and controllers

Audio & video connector

6731 57	3 x female RCA -1 module	3930	1/10
6731 58	3 pole XLR sockets 2 module	3706	10/100

Sound

6731 63	Suitable for 8 Ohms, 8 Ohms, 3 Watts (RNS) speaker - 2 module	1890	1/10/100
---------	---	------	----------

Protectors and accessories

Motor starter

6731 30	16 A motor starter- 2 module	936	1/10/100
6731 31	25 A motor starter- 2 module	958	1/10/100

Modular MCB (IS : 60898-1:2002)

6731 64	16A MCB SP 1M C curve	548	1/10/100
6731 65	20A MCB SP 1M C curve	548	1/10/100

Accessories

6731 60	Cable outlet - 8mm 1 module	370	20/200
6731 61	Blanking plate-1 module	74	20/200

Plastic plates

White plates with frame

6732 01	1 Module plate + Frame	226	20/200
6732 02	2 Module plate + Frame	242	20/200
6732 03	3 Module plate + Frame	256	10/100
6732 04	4 Module plate + Frame	276	10/100
6732 06	6 Module plate + Frame	496	5/50
6732 08	8 Module plate + Frame (horizontal)	546	5/50
6732 09	8 Module plate + Frame (4x2)	678	5/25
6732 12	12 Module plate + Frame	822	1/10
6732 16	16 Module plate + Frame	950	1/10
6732 18	18 Module plate + Frame	1096	1/10

* MRP - Maximum Retail Price Inclusive of all taxes including GST.
 * To be Introduced Shortly

Myrius™ Regular plates with frame

Cat.Nos	Description	MRP* ₹ / Unit	Pack
---------	-------------	------------------	------

New white plates with frame*

6732 11	1 Module plate + Frame	234	20/200
6732 42	2 Module plate + Frame	248	20/200
6732 13	3 Module plate + Frame	270	10/100
6732 14	4 Module plate + Frame	284	10/100
6732 66	6 Module plate + Frame	558	5/50
6732 68	8 Module plate + Frame (Horizontal)	596	5/50
6732 69	8 Module plate + Frame (4x2)	748	5/25
6732 62	12 Module plate + Frame	906	1/10
6732 56	16 Module plate + Frame	1056	1/10
6732 58	18 Module plate + Frame	1210	1/10

Black plates with frame

6732 21	1 Module plate + Frame	386	20/200
6732 22	2 Module plate + Frame	416	20/200
6732 23	3 Module plate + Frame	442	10/100
6732 24	4 Module plate + Frame	492	10/100
6732 26	6 Module plate + Frame	850	5/50
6732 28	8 Module plate + Frame (Horizontal)	948	5/50
6732 29	8 Module plate + Frame (4 x 2)	1170	5/25
6732 32	12 Module plate + Frame	1396	1/10
6732 36	16 Module plate + Frame	1638	1/10
6732 38	18 Module plate + Frame	1854	1/10

New black plates with frame*

6732 31	1 Module plate + Frame	438	20/200
6732 82	2 Module plate + Frame	482	20/200
6732 33	3 Module plate + Frame	516	10/100
6732 34	4 Module plate + Frame	558	10/100
6732 86	6 Module plate + Frame	984	5/50
6732 88	8 Module plate + Frame (Horizontal)	1074	5/50
6732 89	8 Module plate + Frame (4 x 2)	1344	5/25
6732 92	12 Module plate + Frame	1618	1/10
6732 96	16 Module plate + Frame	1884	1/10
6732 98	18 Module plate + Frame	2126	1/10

Mounting boxes

Flush mounting boxes

6890 07	Flush box - 1/2 module	142	40
6890 08	Flush box - 3 module	142	40
6890 09	Flush box - 4 module	188	40

Bold Cat.Nos are products normally available with Legrand (India) Stockists. Cat.Nos that are not bold - delivery within 4 - 8 weeks from the date of order. Bold packing quantity is our mandatory packing. Orders to be placed by Legrand (India) Stockist in multiples of the same.



6731 63



6732 01



6732 03



6732 11



6732 42



6732 14



6732 22



6732 24



6732 82



6732 33



6732 34



6732 92



6890 07

Myrius™ Regular mounting boxes

Cat.Nos	Description	MRP* ₹ / Unit	Pack
---------	-------------	------------------	------

Flush mounting boxes

6890 10	Flush box - 6 module	298	40
6890 42	Flush box - 8 module	348	40
6890 31	Flush box - 8 module (2 row x 4)	346	20
6890 11	Flush box - 12/16 (2 row x 6) module (metal box)	524	10
6890 12	Flush box - 18 module (metal box)	658	10



6890 11

Surface mounting boxes

6733 02	Surface box - 1/2 module	90	10/50
6733 03	Surface box - 3 module	104	5/35
6733 04	Surface box - 4 module	122	5/25
6733 06	Surface box - 6 module	158	1/10
6733 08	Surface box - 8 module	236	1/5
6733 05	Surface box - 8 (2 row x 4) module	224	1/5

Metal surface boxes

6890 21	Metal surface box - 12/16 (2 row x 6) module	558	1/6
6890 22	Metal surface box - 18 module	584	1/4

* MRP - Maximum Retail Price Inclusive of all taxes including GST.
The new plate range will be introduced shortly.

Myrius™

Guarantee

- The Company, at its discretion, will replace products if they have any manufacturing defect within 10 years for switches (without LED lamp) and power sockets. For all other **Myrius™** wiring accessories the guarantee will be 2 years.
- The above guarantee is applicable when the devices are used in Legrand metal flush boxes. Otherwise the guarantee period will be reduced by 50%.
- The guarantee is only applicable when the products are installed as per the Company's instructions and not tampered in any manner.
- The guarantee states the Company's entire liability. It does not extend to cover consequential loss or damage or installation costs arising from defective products.

* MRP - Maximum Retail Price Inclusive of all taxes including GST.
The new plate range will be introduced shortly.

Mylinc™

A little touch of genius

A LITTLE TOUCH OF GENIUS

Mylinc™ is a complete range of modular wiring accessories. Switches and sockets designed and made in India, keeping everyone's requirements in mind. Whether it's safety, reliability, convenience or beauty; Mylinc™ is the smart option in modular switch design.



Remote control unit for Light and Fan



USB Charger



8 Step Fan Regulator



Modular MCB



Champagne



Silver Alu





Dark Bronze



Matt Grey



Pearl White



Motor Starter



Skirting Light 2 M



Switch 25 A with indicator

Mylinc™

A little touch of genius

A LITTLE TOUCH OF GENIUS



Screwless finish & rounded corners that add beauty to any home



Linc-Loc™ intelligent design prevents wrong fitting, misaligned switches and sockets



Laser marking safeguards against fakes



Safety feature for mishap-proof use



Indicators for correct orientation



Front Removal



Stripping Template



ISI marking



CE marking

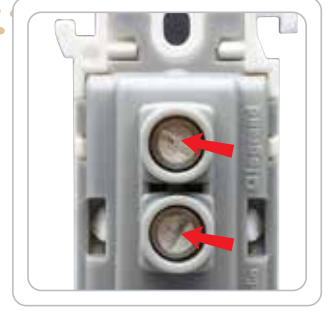

Finger-proof terminals for IP 20 protection against accidental contact

1 lac operations

with a guarantee of 100,000 operations, assuming an average switch is operated 10 times a day, this product is dependable for 27 years.

Mylic™ mechanisms white

Cat.Nos	Description	MRP* ₹ / Unit	Pack
---------	-------------	------------------	------

Switches and accessories

Switches 6 A - 250 V AC

6755 01	6 A one-way SP switch - 1 module	100	20/400
6755 02	6 A two-way SP switch - 1 module	194	20/200
6755 03	6 A one-way SP switch with indicator - 1 module	218	20/200

Switches 16 A - 250 V AC

6755 11	16 A one-way SP switch - 1 module	216	20/200
6755 12	16 A two-way SP switch - 1 module	272	20/200
6755 13	16 A one-way SP switch with indicator - 1 module	280	20/200

Switch 25 A - 250 V AC

6759 68	Switch 25 A with indicator - 1 module	330	10/100
---------	--	-----	--------

Switches 32 A - 250 V AC

6755 26	32 A one-way double pole switch with indicator - 2 module	644	10/100
---------	--	-----	---------------

Push buttons 6 A - 250 V AC

6755 04	6 A one-way SP bell push - 1 module	198	20/200
6755 06	6 A one-way SP bell push with indicator - 2 module	394	10/100

Bell call indicator & register - 6 A - 250 V AC

6755 07	Bell call Indicator with register - 6 A - one-way - SP - 1 module	1066	20/200
---------	--	------	---------------

Lighting modules

6755 95	Indicator light red - 1 module	250	20/200
6755 96	Indicator light orange - 1 module	250	20/200
6755 97	Skirting light with white LED - 3 module	806	1/5/25
6759 76	Skirting light with white LED - 2 module	540	5/50

Dimmers and fan regulators

6755 35	Rotative dimmer 60 - 250 W for light - 2 module	672	1/10/100
6755 33	Mylic dimmer 400 W for light - 1 module	854	1/5/50
6759 64	Fan regulator 100 W ISI with 360° rotation - 2 module	762	10/100
6755 30	Fan regulator 100 W, ISI Humfree, 0-4 steps - 2 module	820	1/10/100
6755 31	Fan regulator 100 W, Humfree, 0-4 steps - 1 module	614	1/5/50
6759 77	Fan regulator 8 steps - 2 module	820	1/10/100

Mylic™ mechanisms white

Cat.Nos	Description	MRP* ₹ / Unit	Pack
---------	-------------	------------------	------

Buzzer

6755 40	Mylic buzzer	714	20/200
---------	--------------	-----	---------------

Remote unit

6759 75	Remote control unit with remote for 4 switch & fan load 4 m	3752	1/5/20
---------	---	------	--------

DND & MMR

Indicator lamp

6755 56	DND & MMR external unit with bellpush 3 m	380	10/50
6759 69	DND & MMR external unit with bellpush 1+1 - 2 m	380	10/100
6755 57	Mylic internal control unit for DND & MMR	316	10/100

Hotel key fob switch

6755 60	Hotel key fob switch - monobloc	3458	1/10
6730 38	Only key fob for 6755 60	218	1/10

Energy sockets / power unit

Energy sockets

6755 55	6/16A - 3 pin - ISI combine - 2 module	378	10/100
6755 51	6 A - 3 pin ISI - 2 module	246	10/100

Power unit

6755 58	Power unit for 2 ton A.C and 3.5 KW geyser - 4 module	1328	5/25
---------	--	------	-------------

Motor starter

6759 65	Motor starter 16 A 2 m	616	1/10/100
---------	------------------------	-----	----------

Modular MCB (IS : 60898-1:2002)

6759 74	Modular SP MCB 16 A 1 m	434	1/10/100
6756 40	Modular SP MCB 20 A 1 m	434	1/10/100
6756 41	Modular SP MCB 25 A 1 m	434	1/10/100
6756 42	Modular SP MCB 32 A 1 m	434	1/10/100

Low voltage sockets / TV socket and RJ11 telephone socket / accessories

6755 46	TV socket 1 module	204	20/200
6755 41	RJ 11 telephone socket 1 module	194	20/200
6755 44	Double RJ 11 telephone socket 1 module	322	20/200
6759 66	RJ45 socket cat 5e with shutter - 1 module	480	20/200
6759 67	RJ45 socket cat 6 with shutter - 1 module	698	20/200

* MRP - Maximum Retail Price Inclusive of all taxes including GST.

Bold Cat.Nos are products normally available with Legrand (India) Stockists. Cat.Nos that are not bold - delivery within 4 - 8 weeks from the date of order. Bold packing quantity is our mandatory packing. Orders to be placed by Legrand (India) Stockist in multiples of the same.

Mylic™ mechanisms

Cat.Nos	Description	MRP* ₹ / Unit	Pack
---------	-------------	------------------	------

USB chargers (IS13252(Part 1) / IEC 60950-1)

6758 20#	USB Charger 1500mA Type A-1 module	1092	10/100
6755 79	USB Charger 1500mA Type C-1 module	1432	1/10/100
6759 72	Double USB Charger 2000mA Type A-2 module	1644	10/100
6755 80	Double USB Charger 3000mA Type A & Type C -2 module	2383	10/100

Accessories

6755 91	Cable outlet - 1 module	176	20/200
6755 90	Blanking plate 0.8 mm - 1 module	50	20/200
6755 92	Spare 12 screws with nuts	64	20/200

Mylic™ plates

Modular white plates with frame

6755 61	1 module plate - white	142	20/200
6755 62	2 modules plate - white	142	20/200
6755 63	3 modules plate - white	194	10/100
6755 64	4 modules plate - white	216	10/100
6755 66	6 modules plate - white	268	5/50
6755 67	8 modules horizontal - white	344	5/50
6755 68	4x2 modules plate - white	350	5/25
6755 69	9 modules plate- white	412	5/50
6755 72	12 modules plate - white	504	10
6755 73	16 modules plate - white	588	10
6755 78	18 modules plate - white	786	10

Mylic™ mechanism matt grey

Switches and accessories

Switches 6 A - 250 V AC

6763 01	6 A one-way SP switch - 1 module	120	20/200
6763 02	6 A two-way SP switch - 1 module	208	20/200
6763 03	6 A one-way SP switch with indicator - 1 module	246	20/200

Switches 16 A - 250 V AC

6763 11	16 A one-way SP Switch 1 module	236	20/200
6763 12	16 A two-way SP switch 1 module	294	20/200
6763 13	16 A one-way SP switch with indicator 1 module	320	20/200

Switch 25 A - 250V AC

6763 41	Switch 25 A with indicator - 1 module	370	10/100
---------	--	-----	---------------

Switches 32 A - 250V AC

6763 26	32 A one-way double pole switch with indicator - 2 module	714	20/200
---------	--	-----	---------------

Push buttons 6 A - 250 V AC

6763 04	6 A one-way SP bell push 1 module	210	20/200
6763 06	6 A one-way SP bell push with indicator 2 module	436	10/100

* MRP - Maximum Retail Price Inclusive of all taxes including GST.
* To be Introduced Shortly

Mylic™ mechanism matt grey

Cat.Nos	Description	MRP* ₹ / Unit	Pack
---------	-------------	------------------	------

Bell call indicator & register - 6 A - 250 V AC

6763 07	Bell call indicator with register - 6 A - one way 1 module	1176	20/200
---------	---	------	---------------

Lighting modules

6763 14	Indicator light red 1 module	272	20/200
6763 15	Indicator light orange 1 module	272	20/200
6763 16	Skirting light with white LED - 3 module	882	1/5/25
6763 10	Skirting light with white LED - 2 module	596	5/50

Dimmers and fan regulators

6763 17	Rotative dimmer 60 - 250 W for light 2 module	744	1/10/100
6763 18	Rotative dimmer 60 - 400 W 1 module	944	1/5/50
6763 37	Fan regulator 100 W, ISI with 360° rotation 2 module	838	10/100
6763 19	Fan regulator 100 W, ISI Humfree 0-4 steps 2 module	902	1/10/100
6763 20	Fan regulator 4 step 1 module	672	1/5/50
6763 08	Fan regulator 8 step 2 module	898	1/10/100

Buzzer

6763 21	Mylic buzzer	782	20/200
---------	--------------	-----	---------------

Remote unit

6763 47	Remote control unit with remote for 4 switch & fan load 4 m	4130	1/5/20
---------	---	------	---------------

DND & MMR

Indicator lamp

6763 42	DND & MMR external unit with bellpush 1+1	418	10/100
6763 23	Mylic internal control unit for DND & MMR	348	10/100

Hotel key fob switch

6730 38	Only key fob for 6755 60	218	1/10
6763 24	Hotel key fob switch monobloc	3834	1/10

Energy sockets / power unit

Energy sockets

6763 05	6/16A - ISI - 3 pin Combined 2 module	406	10/100
6763 27	6 A - 3 pin ISI - 2 module	272	10/100

Bold Cat.Nos are products normally available with Legrand (India) Stockists. Cat.Nos that are not bold - delivery within 4 - 8 weeks from the date of order. Bold packing quantity is our mandatory packing. Orders to be placed by Legrand (India) Stockist in multiples of the same.

Mylic™ mechanism matt grey

Cat.Nos	Description	MRP* ₹ / Unit	Pack
---------	-------------	------------------	------

Energy sockets / power unit

Power unit

6763 31	Power unit for 2 ton A.C and 3.5 KW geyser - 4 module	1500	5/25
---------	--	------	------

Motor starter

6763 38	Motor starter 16 A 2 m	684	1/10/100
---------	------------------------	-----	----------

Modular MCB (IS : 60898-1:2002)

6763 46	Modular SP MCB 16 A 1 m	488	1/10/100
---------	-------------------------	-----	----------

Low voltage sockets / TV socket and RJ11 telephone socket / accessories

Sockets

6763 32	TV socket - 1 module	212	20/200
6763 33	RJ 11 telephone 1 module	210	20/200
6763 34	Double RJ 11 telephone socket 1 module	348	20/200
6763 39	RJ 45 socket cat 5e with shutter 1 module	516	20/200
6763 40	RJ 45 socket cat 6 with shutter 1 module	720	20/200

USB chargers (IS13252(Part 1) / IEC 60950-1)

6758 21 [#]	USB Charger 1500mA Type A-1 module	1196	10/100
6764 79	USB Charger 1500mA Type C-1 module	1576	1/10/100
6763 44	Double USB Charger 2000mA Type A-2 module	1808	1/10/100
6764 80	Double USB Charger 3000mA Type A & Type C-2 module	2736	1/10/100

Accessories

6763 48	Cable outlet 1 module	198	20/200
6763 49	Blanking plate 0.8 mm 1 module	56	20/200

Mylic™ plates

Modular Matt Grey plates with frame

6763 50	Matt grey plate 1 m	184	20/200
6763 51	Matt grey plate 2 m	184	20/200
6763 52	Matt grey plate 3 m	258	10/100
6763 53	Matt grey plate 4 m	274	10/100
6763 54	Matt grey plate 6 m	348	5/50
6763 55	Matt grey plate 8 m horizontal	448	5/50
6763 56	Matt grey plate 4x2 m	460	5/25
6763 57	Matt grey 9 m	534	5/50
6763 58	Matt grey plate 12 m	652	10
6763 59	Matt grey plate 18 m	1034	10

Modular colour plates with frame

Cat.Nos	Description	MRP* ₹ / Unit	Pack
---------	-------------	------------------	------

Pearl white cover plates

6763 60	Pearl white plate 1 m	174	10/100
6763 61	Pearl white plate 2 m	174	10/100
6763 62	Pearl white plate 3 m	230	10/100
6763 63	Pearl white plate 4 m	252	10/100
6763 64	Pearl white plate 6 m	334	5/50
6763 65	Pearl white 8 m plate horizontal	422	5/50
6763 66	Pearl white plate 4x2 m	426	5/25
6763 67	Pearl white plate 9 m	492	5/50
6763 68	Pearl white plate 12 m	604	5/25
6763 69	Pearl white plate 18 m	950	5/25

Champagne cover plates

6763 70	Champagne plate 1 m	174	10/100
6763 71	Champagne plate 2 m	174	10/100
6763 72	Champagne plate 3 m	230	10/100
6763 73	Champagne plate 4 m	252	10/100
6763 74	Champagne plate 6 m	334	5/50
6763 75	Champagne plate 8 m horizontal	422	5/50
6763 76	Champagne plate 4x2 m	426	5/25
6763 77	Champagne plate 9 m	492	5/50
6763 78	Champagne plate 12 m	604	5/25
6763 79	Champagne plate 18 m	950	5/25

Silver alu cover plates

6763 80	Silver alu plate 1 m	174	10/100
6763 81	Silver alu plate 2 m	174	10/100
6763 82	Silver alu plate 3 m	230	10/100
6763 83	Silver alu plate 4 m	252	10/100
6763 84	Silver alu plate 6 m	334	5/50
6763 85	Silver alu plate 8 m horizontal	422	5/50
6763 86	Silver alu plate 4x2 m	426	5/25
6763 87	Silver alu plate 9 m	492	5/50
6763 88	Silver alu plate 12 m	604	5/25
6763 89	Silver alu plate 18 m	950	5/25

Dark bronze cover plates

6763 90	Dark bronze plate 1 m	174	10/100
6763 91	Dark bronze plate 2 m	174	10/100
6763 92	Dark bronze plate 3 m	230	10/100
6763 93	Dark bronze plate 4 m	252	10/100
6763 94	Dark bronze plate 6 m	334	5/50
6763 95	Dark bronze plate 8 m horizontal	422	5/50
6763 96	Dark bronze plate 4x2 m	426	5/25
6763 97	Dark bronze plate 9 m	492	5/50
6763 98	Dark bronze plate 12 m	604	5/25
6763 99	Dark bronze plate 18 m	950	5/25

* MRP - Maximum Retail Price Inclusive of all taxes including GST.
[#] To be Introduced Shortly

Bold Cat.Nos are products normally available with Legrand (India) Stockists. Cat.Nos that are not bold - delivery within 4 - 8 weeks from the date of order. Bold packing quantity is our mandatory packing. Orders to be placed by Legrand (India) Stockist in multiples of the same.

Mylic™ boxes

Cat.Nos	Description	MRP* ₹ / Unit	Pack
Modular white surrounds			
6755 81	1 module	50	20/200
6755 82	2 modules	76	20/200
6755 83	3 modules	76	10/100
6755 84	4 modules	120	10/100
6755 86	6 modules	170	10/100
6755 89	(2 column x 3) 9 modules	296	10/100
6755 89	(3 column x 3) 9 modules	296	10/100
Metal flush boxes			
6890 07	Flush box - 1/2 modules	142	40
6890 08	Flush box - 3 modules	142	40
6890 09	Flush box - 4 modules	188	40
6890 10	Flush box - 6 modules	298	40
6890 42	Flush box - 8 modules	348	40
6890 31	Flush box - 4 x 2 modules	346	20
6890 29	Flush box - 9 modules	410	20
6890 11	Flush box- 12/16 modules	524	10
6890 13	Flush box - 16 modules	600	10
6890 12	Flush box - 18 modules	658	10
Plastic surface boxes			
6733 02	Surface box- 1/2 modules	90	10/50
6733 03	Surface box- 3 modules	104	5/35
6733 04	Surface box- 4 modules	122	5/25
6733 06	Surface box- 6 modules	158	1/10
6733 08	Surface box- 8 modules	236	1/5
6733 05	Surface box- 4 x 2 modules	224	1/5
6740 99	Surface box- 9 modules	264	1/5
Metal surface boxes			
6890 21	Metal surface box- 12 modules (2 rows x 6)	558	1/6
6890 22	Metal surface box- 18 modules (3 rows x 6)	584	1/4

Mylic™

A little touch of genius

A LITTLE TOUCH OF GENIUS



Guarantee

- The Company, at its discretion, will replace products if they have any manufacturing defect within 10 years for switches (without LED lamp) and power sockets. For all other **Mylic™** wiring accessories the guarantee will be 2 years.
- The above guarantee is applicable when the devices are used in Legrand metal flush boxes. Otherwise the guarantee period will be reduced by 50%.
- The guarantee is only applicable when the products are installed as per the Company's instructions and not tampered in any manner.
- The guarantee states the Company's entire liability. It does not extend to cover consequential loss or damage or installation costs arising from defective products.

* MRP - Maximum Retail Price Inclusive of all taxes including GST.

LyncusTM

Change to today

TIME TO CHANGE
TO TODAY



Today's homes need a range that mirrors their look. A modern sleek look with clean lines. A look that is chic and futuristic. Our new Lyncus range brings the aesthetic to your home, but with a subtle touch that adds character to every room



White



Chic Grey



Scan to know more about
the product.

Lyncus™

Change to today

TIME TO CHANGE
TO TODAY



RANGE



Brushed



Alu Sunset



Champagne



Matt Silver



USB TYPE C



USB TYPE A + TYPE C



COMBI TWIN USB



REMOTE CONTROL UNIT



BLUETOOTH SOUND RECEIVER



ONE WAY
TOUCH SWITCH



TOUCH FAN
REGULATOR



UNIVERSAL
TOUCH DIMMER

Lyncus™

mechanisms white

Cat.Nos	Description	MRP* ₹ / Unit	Pack
---------	-------------	------------------	------

Switches 6 A 230 V AC

6772 00	6 A Switch 1 W 1 module	88	20/200
6772 01	6 A Switch 2 W 1 module	170	20/200
6772 02	6 A Switch 1 W 1 module with indicator	170	20/200
6772 03	6 A Switch 1 W 1 module with "Light" marking	156	20/200
6772 04	6 A Switch 1 W 1 module with "Fan" marking	156	20/200

Switches 10 A 230 V AC

6772 05	10 A Switch 1 W 2 module	208	10/100
6772 06	10 A Switch 2 W 2 module	246	10/100
6772 07	10 A Intermediate switch 2 module	1386	10/100
6772 08	10 A Switch 1 W with indicator 2 module	266	10/100

Switches 16 A 230 V AC

6772 09	16 A Switch 1 W 1 module	194	20/200
6772 10	16 A Switch 2 W 1 module	244	20/200
6772 11	16 A Switch 1 W with indicator 1 module	252	20/200

Switches 20A 230V AC

6772 12	20 A Switch 1 W 1 module	286	20/200
6772 13	20 A DP Switch 1 W 2 module	418	10/100
6772 14	20 A DP Switch 1 W with indicator 2 module	426	10/100
6772 15	20 A Switch 2 way 2 module	476	10/100

Switches 25 A 230 V AC

6772 16	25 A SP 1 W Switch with indicator 1 module	296	20/200
---------	--	-----	--------

Switches 32 A 230 V AC

6772 17	32 A DP Switch with indicator 2 module	576	10/100
---------	--	-----	--------

Push button 6 A 230 V AC

6772 18	6 A Push button SP 1 module	138	20/200
6772 19	6 A Push button SP with indicator 1 module	198	20/200
6772 20	6 A Bell push 1 module	182	20/200
6772 21	6 A Bell push with indicator 1 module	212	20/200
6772 22	6 A Bell push 2 module	244	10/100
6772 23	6 A Bell push with indicator 2 module	358	10/100

Accessories for switches

6772 24	LED Indicator for switches	42	5/50
---------	----------------------------	----	------

Socket 240 V AC

6772 26	16 A 3 Pin Switched socket 3 module	610	5/50
6772 29	6/16 A Socket 3 module	386	5/50
6772 30	6/16 A Socket 2 module	324	10/100
6772 32	25 A Socket 2 module	324	10/100
6772 35	6A 3 Pin ISI Socket - 2 module	158	1/20/200

Dimmers and fan regulators

6772 36	Rotary light dimmer 400 W 1 module	580	5/50
6772 37	Rotary light dimmer 500 W 2 module	742	10/100
6772 39	Fan regulator 100 W ISI 1 module	532	5/50

Lyncus™

mechanisms white

Cat.Nos	Description	MRP* ₹ / Unit	Pack
---------	-------------	------------------	------

6772 40	Fan regulator 100 W ISI 360 degree 2 module	656	10/100
6772 41	Fan regulator 120 W ISI 360 degree 2 module	750	10/100
6772 42	Fan regulator 70 W ISI 1 module	716	1/10/100
6772 44	Fan Regulator 8 step 100 W ISI 2 module	588	1/10/100

Emergency light

6772 43	Removable LED lamp 2 module	2450	1/12
---------	-----------------------------	------	------

Skirting light

6772 48	LED skirting light 3 module	510	10/100
---------	-----------------------------	-----	--------

Indicator

6772 87	Indicator unit 1 module with transparent led & colored labels	540	10/100
---------	---	-----	--------

Bell call indicator

6772 49	Bell call indicator 240 V 1 module	1010	20/200
---------	------------------------------------	------	--------

Buzzer

6772 50	Buzzer 230 V 1 module	680	20/200
---------	-----------------------	-----	--------

Infrared Sensors

6772 51	Infrared sensor 400 W 2 module	1528	1/50
---------	--------------------------------	------	------

Remote unit

6772 52	Remote control unit for light & fan 4 module	3928	1/5/20
6773 03	Remote control hand unit	646	1/5/30

Hospitality function

Hotel keycard switch

6772 53	16 A Key card switch 2 module	3190	1/10
6772 55	Credit card size key fob	106	10/100

Hotel "DND and MMR" functions

6772 56	DND & MMR indicator with bell push 1+1 module	352	10/100
6772 57	Internal control unit for DND & MMR 1+1 module	286	10/100

Shaver socket

6772 58	Shaver socket 120/240 V MonoBlock with plate 2 module	2448	1/16
---------	---	------	------

Sockets and connectors

TV sockets

6772 60	TV Coaxial socket 1 module	182	20/200
---------	----------------------------	-----	--------

Data & voice

6772 62	Telephone socket RJ11 1 module	170	20/200
6772 63	Telephone socket double RJ11 1 module	278	20/200
6772 64	RJ 45 UTP cat 5 tooless with shutter 1 M white	454	20/200
6772 65	RJ 45 UTP cat 6 tooless with shutter 1 M white	634	20/200

* MRP - Maximum Retail Price Inclusive of all taxes including GST.
Red Cat.Nos - new products

Bold Cat.Nos are products normally available with Legrand (India) Stockists. Cat.Nos that are not bold - delivery within 4 - 8 weeks from the date of order. Bold packing quantity is our mandatory packing. Orders to be placed by Legrand (India) Stockist in multiples of the same.

Lyncus™ sockets and connectors

Cat.Nos	Description	MRP* ₹ / Unit	Pack
---------	-------------	------------------	------

Audio video connectors

6772 67	Preterminated audio video connector 1 module	1326	1/10
6772 68	Preterminated HDMI socket 1 module	1628	1/10
6772 69	Preterminated projector connector 1 module	1628	1/10

Sound (Volume controller)

6772 70	Volume controller 2 module	1046	1/10/100
---------	----------------------------	------	----------

Protectors and accessories

Motor starter

6772 71	16 A Motor starter 2 module	636	1/10/100
6772 72	25 A Motor starter 2 module	636	1/10/100

VSP

6772 74	Voltage surge protector 230 V 1 module	2042	20/200
---------	--	------	--------

Modular MCB (IS : 608981:2002)

6772 81	16 A MCB SP 1 M C curve	420	1/10/100
6772 82	20 A MCB SP 1 M C curve	420	1/10/100
6772 83	32 A MCB SP 1 M C curve	420	1/10/100

Electronic function

USB chargers (IS13252 (Part 1) / IEC 60950-1)

6772 91*	USB Charger 1500 mA Type A-1 module	1042	1/5/50
6772 89	Double USB charger 3000 mA 2 module Type A & Type C-2 module	2410	1/10/100
6772 90	USB Charger 1500 mA Type C-1 module	1160	1/5/50

Combi (Socket + USB)

6772 92	Combi twin USB 2400 Ma Type A with multistandard socket-3 module	2780	1/5/50
6772 94	Combi twin USB 2400 Ma Type A & Type C with multistandard socket-3 module	3060	1/5/50
6772 33	Combi Twin USB 3.1A Type A with Euro Socket - 2 Module	1766	1/10/100
6772 34	Combi Twin USB 3.1A Type A & Type C with Euro Socket - 2 Module	2352	1/10/100

Loud speakers

6772 98	Loudspeaker for false ceiling & plaster board 8 Ohms 10 W	2100	1/6
---------	---	------	-----

Sound diffusion

6772 99*	Bluetooth sound diffusion 2 module	4628	1/10/100
----------	------------------------------------	------	----------

Rotary dimmer universal

6773 04	Rotary led light dimmer 50 W 1 module	2140	1/10/120
---------	---------------------------------------	------	----------

Touch switches

6773 09	6 A Touch switch 1 W 2 module	3282	1/50
6773 10	6 A Touch Switch 2 W 2 Module	3794	1/50

Lyncus™ electronic function

Cat.Nos	Description	MRP* ₹ / Unit	Pack
---------	-------------	------------------	------

6773 13	16 A Touch switch 1 W 2 module	3794	1/50
6773 06	6 A Touch bell push 2 module	3282	1/50

Touch regulator & dimmer

6773 05	Touch fan regulator 100 W 2 module	3794	1/50
6773 15	300 W Universal led touch light scroll dimming 2 module	3794	1/50

Reading light

6773 16	Reading light led	1940	1/12
---------	-------------------	------	------

Accessories

6772 75	Cable outlet 8 mm 1 module	162	20/200
6772 76	Blanking plate 1 module	42	40/400
6772 77	Blanking plate 2 module	56	10/100

Lyncus™ mechanisms chic grey

Switches 6A 230V AC

6774 00	6 A Switch 1 W 1 module	106	20/200
6774 01	6 A Switch 2 W 1 module	196	20/200
6774 02	6 A Switch 1 W 1 module with Indicator	198	20/200
6774 03	6 A Switch 1 W 1 module with "Light" marking	190	20/200
6774 04	6 A Switch 1 W 1 module with "Fan" marking	190	20/200

Switches 10A 230V AC

6774 05	10 A Switch 1 W 2 module	244	10/100
6774 06	10 A Switch 2 W 2 module	278	10/100
6774 07	10 A Intermediate switch 2 module	1596	10/100
6774 08	10 A Switch 1 W with Indicator 2 module	308	10/100

Switches 16A 230V AC

6774 09	16 A Switch 1 W 1 module	216	20/200
6774 10	16 A Switch 2 W 1 module	274	20/200
6774 11	16 A Switch 1 W with indicator 1 module	286	20/200

Switches 20A 230V AC

6774 12	20 A Switch 1 W 1 module	334	20/200
6774 13	20 A DP Switch 1 W 2 module	482	10/100
6774 14	20 A DP Switch 1 W with indicator 2 module	490	10/100
6774 15	20 A Switch 2 W 2 module	554	10/100

Switches 25A 230V AC

6774 16	25A SP 1 W Switch with indicator 1 module	344	20/200
---------	---	-----	--------

Switches 32A 230V AC

6774 17	32A DP Switch with indicator 2 module	658	10/100
---------	---------------------------------------	-----	--------

Push button 6 A 230 V AC

6774 18	6 A Push button SP 1 module	160	20/200
6774 19	6 A Push button SP with indicator 1 module	226	20/200

* MRP - Maximum Retail Price Inclusive of all taxes including GST.

** To be Introduced Shortly

** Charging only with wireless compatible phone having induction receiver technology

Red Cat.Nos - new products

Bold Cat.Nos are products normally available with Legrand (India) Stockists. Cat.Nos that are not bold - delivery within 4 - 8 weeks from the date of order. Bold packing quantity is our mandatory packing. Orders to be placed by Legrand (India) Stockist in multiples of the same.

Lyncus™ mechanisms chic grey

Cat.Nos	Description	MRP* ₹ / Unit	Pack
6774 20	6 A Bell push 1 module	208	20/200
6774 21	6 A Bell push with indicator module	250	20/200
6774 22	6 A Bell push 2 module	274	10/100
6774 23	6 A Bell Push with indicator 2 module	412	10/100

Sockets 240 V AC

6774 29	6/16A ISI Socket 3 module	446	5/50
6774 30	6/16A ISI Socket 2 module	376	10/100
6774 32	25 A socket 2 module	376	10/100
6774 35	6A 3 Pin ISI Socket 2 module	184	1/20/200

Dimmers and fan regulators

6774 36	Rotary light dimmer 400 W 1 module	664	5/50
6774 37	Rotary light dimmer 500 W 2 module	854	10/100
6774 39	Fan regulator 100 W ISI 1 module	614	5/50
6774 40	Fan regulator 100 W ISI 360 degree 2 module	756	10/100
6774 41	Fan regulator 120 W ISI 360 degree 2 module	860	10/100
6774 42	Fan step regulator 70 W ISI 2 module	828	1/10/100
6774 44	Fan regulator 100 W 8 step 2 module	678	1/10/100

Skirting light

6774 48	LED skirting light 3 module	580	10/100
---------	-----------------------------	-----	--------

Bell call indicator

6774 49	Bell call indicator 240 V 1 module	1140	20/200
---------	------------------------------------	------	--------

Buzzer

6774 50	Buzzer 230 V 1 module	770	20/200
---------	-----------------------	-----	--------

Remote unit

6774 52	Remote control unit for light & fan 4 module	4220	1/5/20
6773 03	Remote control hand unit	646	1/5/30

Hospitality function

Hotel keycard switch

6774 53	16A Key card switch 2 module credit card size key fob	3600	1/10
---------	---	------	------

Hotel "DND and MMR" functions

6774 56	DND & MMR indicator with bell push 1+1 module	406	10/100
6774 57	Internal control unit for DND & MMR 1+1 module	324	10/100

Shaver socket

6774 58	Shaver socket 120/240 V MonoBlock with plate 2 module	2736	1/16
---------	---	------	------

Sockets and connectors

TV sockets

6774 60	TV Coaxial socket 1 module	202	20/200
---------	----------------------------	-----	--------

Lyncus™ hospitality function

Cat.Nos	Description	MRP* ₹ / Unit	Pack
---------	-------------	------------------	------

Data & voice

6774 62	Telephone socket RJ11 1 module	192	20/200
6774 63	Telephone socket double RJ11 1 module	326	20/200
6774 64	RJ 45 UTP cat 5 tooless with shutter 1 M grey	498	20/200
6774 65	RJ 45 UTP cat 6 tooless with shutter 1 M grey	696	20/200

Audio video sockets

6774 67	Preterminated audio video connector 1 module	1530	1/10
6774 68	Preterminated HDMI socket 1 module	1868	1/10
6774 69	Preterminated projector connector 1 module	1868	1/10

Sound (Volume controller)

6774 70	Volume controller 2 module	1206	1/10/100
---------	----------------------------	------	----------

Electronic function

USB chargers (IS13252 (Part 1) / IEC 609501)

6774 91	USB Charger 1500 mA Type A-1 module	1184	1/5/50
6774 89*	Double USB charger 3000 Ma Type A & Type C-2 module	2770	1/10/100
6774 90	USB Charger 1500 mA Type C-1 module	1336	1/5/50

Combi (Socket+USB)

6774 92	Combi twin USB 2400 Ma Type A with multistandard socket-3 module	3194	1/5/50
6774 94	Combi twin USB 2400 Ma Type A & Type C with multistandard socket-3 module	3520	1/5/50
6774 33	Combi Twin USB 3.1A Type A with Euro Socket - 2 Module	2030	1/10/100
6774 34	Combi Twin USB 3.1A Type A & Type C with Euro Socket - 2 Module	2706	1/10/100

Sound receiver

6774 99*	Bluetooth sound diffusion 2 module	5322	1/10/100
----------	------------------------------------	------	----------

Rotary dimmer universal

6774 24	Rotary led dimmer 50 W 1 module	2710	1/120
---------	---------------------------------	------	-------

Accessories

6774 75	Cable outlet 8 mm 1 module	194	20/200
6774 76	Blanking plate 1 module	44	40/400

plate frame

Lyncus plate frame white

6775 01	Classic white plate + Frame 1 M	132	20/200
6775 02	Classic white plate + Frame 2 M	132	20/200
6775 03	Classic white plate + Frame 3 M	168	10/100
6775 04	Classic white plate + Frame 4 M	190	10/100

* MRP - Maximum Retail Price Inclusive of all taxes including GST.

Red Cat.Nos - new products

To be Introduced Shortly

Bold Cat.Nos are products normally available with Legrand (India) Stockists. Cat.Nos that are not bold - delivery within 4 - 8 weeks from the date of order. Bold packing quantity is our mandatory packing. Orders to be placed by Legrand (India) Stockist in multiples of the same.

Lyncus™ plate frame

Cat.Nos	Description	MRP* ₹ / Unit	Pack
---------	-------------	---------------------	------

plate frame

Lyncus plate frame white

6775 06	Classic white plate + Frame 6 M	236	5/50
6775 08	Classic white plate + Frame 8 M (H)	300	5/50
6775 09	Classic white plate + Frame 2 x 4 M	316	5/25
6775 10	Classic white plate + Frame 9 M	338	5/50
6775 12	Classic white plate + Frame 12 M	440	10
6775 16	Classic white plate + Frame 16 M	510	10
6776 17*	Classic white plate + Frame 16 M	520	10
6775 18	Classic white plate + Frame 18 M	688	10

Plate frame chic grey

6775 21	Chic grey plate+Frame 1 M	168	20/200
6775 22	Chic grey plate+Frame 2 M	168	20/200
6775 23	Chic grey plate+Frame 3 M	232	10/100
6775 24	Chic grey plate+Frame 4 M	244	10/100
6775 26	Chic grey plate+Frame 6 M	302	5/50
6775 28	Chic grey plate + Frame 8 M (H)	412	5/50
6775 29	Chic grey plate + Frame 2x4 M	412	5/25
6775 30	Chic Grey plate + Frame 9 M	446	5/50
6775 32	Chic grey plate + Frame 12 M	576	10
6775 36	Chic grey plate + Frame 16 M	664	10
6776 37*	Chic grey plate + Frame 16 M	668	1/10
6775 38	Chic grey plate + Frame 18 M	904	10

Plate frame brushed

6775 41	Brushed silver plate + Frame 1 M	174	20/200
6775 42	Brushed silver plate + Frame 2 M	174	20/200
6775 43	Brushed silver plate + Frame 3 M	244	10/100
6775 44	Brushed silver plate + Frame 4 M	252	10/100
6775 46	Brushed silver plate + Frame 6 M	328	5/50
6775 48	Brushed silver plate + Frame 8 M (H)	422	5/50
6775 49	Brushed silver plate + Frame 2x4 M	422	5/25
6775 50	Brushed silver plate + Frame 9M (H)	460	5/50
6775 52	Brushed silver plate + Frame 12 M	608	10
6775 56	Brushed silver plate + Frame 16 M	700	10
6776 57*	Brushed silver plate + Frame 16 M	709	1/10
6775 58	Brushed silver plate + Frame 18 M	950	10

* New 16 M plate is suitable for 16M Metal boxes.
* To be Introduced Shortly
Red Cat.Nos - new products

Lyncus™ plate frame

Cat.Nos	Description	MRP* ₹ / Unit	Pack
---------	-------------	---------------------	------

Plate frame alu sun set

6775 61	Alu sun set plate + Frame 1 M	170	20/200
6775 62	Alu sun set plate + Frame 2 M	170	20/200
6775 63	Alu sun set plate + Frame 3 M	232	10/100
6775 64	Alu sun set plate + Frame 4 M	250	10/100
6775 66	Alu sun set plate + Frame 6 M	320	5/50
6775 68	Alu sun set plate + Frame 8 M	412	5/50
6775 69	Alu sun set plate + Frame 2x4 M	414	5/25
6775 70	Alu sun set plate + Frame 9 M	446	5/50
6775 72	Alu sun set plate + Frame 12 M	588	10
6775 76	Alu sun set plate + Frame 16 M	678	10
6776 77*	Alu sun set plate + Frame 16 M	681	10
6775 78	Alu sun set plate + Frame 18 M	932	10

Plate frame champagne

6775 81	Champagne plate + Frame 1 M	170	20/200
6775 82	Champagne plate + Frame 2 M	170	20/200
6775 83	Champagne plate + Frame 3 M	232	10/100
6775 84	Champagne plate + Frame 4 M	250	10/100
6775 86	Champagne plate + Frame 6 M	320	5/50
6775 88	Champagne plate + Frame 8 M (H)	412	5/50
6775 89	Champagne plate + Frame 2x4 M	414	5/25
6775 90	Champagne plate + Frame 9 M	446	5/50
6775 92	Champagne plate + Frame 12 M	588	10
6775 96	Champagne plate + Frame 16 M	678	10
6776 97*	Champagne plate + Frame 16 M	681	1/10
6775 98	Champagne plate + Frame 18 M	932	10

Plate frame matt silver

6776 01	Matt silver plate + Frame 1 M	170	20/200
6776 02	Matt silver plate + Frame 2 M	170	20/200
6776 03	Matt silver plate + Frame 3 M	232	10/100
6776 04	Matt silver plate + Frame 4 M	250	10/100

Bold Cat.Nos are products normally available with Legrand (India) Stockists.
Cat.Nos that are not bold - delivery within 4 - 8 weeks from the date of order.
Bold packing quantity is our mandatory packing. Orders to be placed by
Legrand (India) Stockist in multiples of the same.

Lyncus™ plate frame

Cat.Nos	Description	MRP* ₹ / Unit	Pack
---------	-------------	---------------------	------

Plate frame matt silver

6776 06	Matt silver plate + Frame 6 M	320	5/50
6776 08	Matt silver plate + Frame 8 M (H)	412	5/50
6776 09	Matt silver plate + Frame 2x4 M	414	5/25
6776 10	Matt silver plate + Frame 9 M	446	5/50
6776 12	Matt silver plate + Frame 12 M	588	10
6776 16	Matt silver plate + Frame 16 M	678	10
6776 67*	Matt silver plate + Frame 16 M	681	1/10
6776 18	Matt silver plate + Frame 18 M	932	10

NEW!

Mounting boxes

Metal flush boxes

6890 07	Flush box - 1/2 module	142	40
6890 08	Flush box - 3 module	142	40
6890 09	Flush box - 4 module	188	40
6890 10	Flush box - 6 module	298	40
6890 42	Flush box - 8 module	348	40
6890 31	Flush box - 8 module (2 row x 4)	346	20
6890 29	Flush box - 9 module	410	20
6890 11	Flush box - 12/16 module	524	10
6890 13*	Flush box - 16 modules*	600	10
6890 12	Flush box - 18 module	658	10

Plastic surface boxes

6733 02	Surface box 1/2 module	90	10/50
6733 03	Surface box 3 module	104	5/35
6733 04	Surface box 4 module	122	5/25
6733 06	Surface box 6 module	158	1/10
6733 08	Surface box 8 module	236	1/5
6733 05	Surface box 8 (2 row x 4) module	224	1/5

Metal surface boxes

6890 21	Surface box 12/16 (2 row x 6) module	558	1/6
6890 22	Surface box 18 module	584	1/4

Lyncus™

Change to today

Guarantee

- The Company, at its discretion, will replace products if they have any manufacturing defect within 10 years for switches (without LED lamp) and power sockets. For all other **Lyncus™** wiring accessories the guarantee will be 2 years.
- The above guarantee is applicable when the devices are used in Legrand metal flush boxes. Otherwise the guarantee period will be reduced by 50%.
- The guarantee is only applicable when the products are installed as per the Company's instructions and not tampered in any manner.
- The guarantee states the Company's entire liability. It does not extend to cover consequential loss or damage or installation costs arising from defective products.



6890 07



6890 08



6890 09



6890 10

NEW!



6733 03



6733 04

Allzy

The All-rounder Switch

The All-rounder Switch For All Of India.

A superior quality switch loaded with features from the house of Legrand.

2 COLOUR MECHANISMS

White



Matt Black



Scan to know more about the product.

5 EXQUISITE PLATE FINISHES.



The Allzy range of switches comes in 5 attractive finishes that are a class apart. It also offers a range of mechanisms in black and white for you to choose from.

Colour Plates:

White

Rose Gold

***Alu
Champagne***

Gold

Matt Black



LIVE THE **ADVANTAGE** OF AN **ALL-ROUNDER.**

RANGE

SWITCHES



6A Switch 1W-
Light Marking



6A Switch 1W-
Fan Marking



20A DP Switch 1W-
Indicator Marking

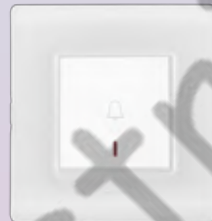

6A Bell Push 1W-
Indicator Marking



Gold- Plate & Frame



Aluminium Champagne-
Plate & Frame



Rose Gold-Plate & Frame



White-Plate & Frame



Matt Black-Plate & Frame

SOCKETS

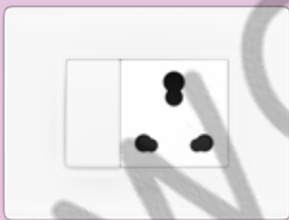

6/16A Socket with shutter
- ISI Mark



6A Multistandard
Switched Socket
1 Gang

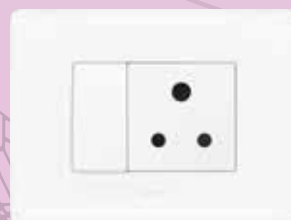

6A 3 Pin Socket with Shutter
- ISI Mark

ELECTRONICS



Fan Regulator 8 step 100W



Fan Regulator 360° 100W
(ISI mark)



Rotary Dimmer 500W



Remote Control Unit

USB



Combi Twin USB 3100mA Type A-Euro US Socket



Combo 6A Multistandard Switched Socket-USB 3100mA Type A, 1 Gang



USB Charger 1500mA Type C



Combi Twin USB 3100mA Type A-Multistandard Socket



Double USB 3100mA Type A & Type C

VOICE & DATA COMMUNICATIONS



Double RJ11 Telephone Socket (with Shutter)



RJ11 Telephone Socket (with Shutter)



RJ45 Cat6 UTP Socket (with Shutter)

AUDIO VIDEO CONNECTOR



Preterminated Audio Video Connector



Preterminated HDMI Socket

PROTECTION



Power Unit with 20A MCB & 16A Plug



32A Modular MCB DP



16A Motor starter

HOSPITALITY



Key card 16A switch-Card 230V



32A DP Key tag switch (Mechanical)



Shaver Socket 120/230V AC with plate



DND & MMR indicator-6A bell push (Outside)



DND & MMR (Inside)



Allzy Mechanisms White



Cat.Nos	Description	MRP* ₹ / Unit	Pack
---------	-------------	------------------	------

Switches 6A 230 V AC

6811 00	6A switch 1 way, 1 module	46	1/20/200
6811 11	6A switch 2 way, 1 module	101	1/20/200
6811 02	6A switch 1 way with indicator 1 module	87	1/20/200
6811 03	6A switch 1 way with "light" marking, 1 module	89	1/20/200
6811 04	6A switch 1 way with "fan" marking, 1 module	89	1/20/200

Switches 16A 230 V AC

6811 01	16A switch 1 way, 1 module	121	1/20/200
6811 12	16A switch 2 way, 1 module	174	1/20/200
6811 05	16A switch 1 way with indicator, 1 module	158	1/20/200

Switches 20A 230V AC

6811 07	20A switch 1 way, 1 module	144	1/20/200
6811 08	20A switch 1 way with indicator, 1 module	188	1/20/200
6811 13	20A SP switch 1 way with indicator, 2 module	218	1/10/100
6811 15	20A DP switch, 1 way, with indicator, 2 module	220	1/10/100

Switches 25 A 230 V AC

6811 06	25A switch 1 way with indicator, 1 module	198	1/20/200
---------	---	-----	----------

Switches 32 A 230 V AC

6811 16	32A DP switch with indicator, 2 module	295	1/10/100
---------	--	-----	----------

Bell Push button 6 A 230 V AC

6811 09	6A bell push 1 way, 1 module	99	1/20/200
6811 10	6A bell push 1 way with indicator, 1 module	121	1/20/200
6811 14	6A bell push 1 way with indicator, 2 module	184	1/10/100

Accessories for switches

6811 37	LED Indicator for switch (red)	37	5/50
---------	--------------------------------	----	------

Socket 240 V AC

6811 24	6A 3 pin Round socket with shutter, (ISI mark), 2 module	150	1/20/200
6811 22	6/16A socket with shutter, (ISI Mark), 2 module	212	1/10/100
6811 26	25A socket with shutter, 2 module	234	1/10/100
6811 29	6A Multistandard Switched Socket, 1 Gang, 2 module	904	1/10
6811 19	6A Multistandard Switched Socket, 2 Gang, 4 module	1716	1/5/20

Dimmers and Fan Regulators

6811 43	Rotary Dimmer 400W, 1 module	441	1/5/50
6811 44	Rotary Dimmer 500W, 2 module	572	1/10/100
6811 40	Fan Regulator 4 step 100W (ISI mark), 1 module	436	1/5/50
6811 41	Fan Regulator 360 degree 100W (ISI mark), 2 module	500	1/10/100
6811 42	Fan Regulator 8 step 100W, 2 module	543	1/10/100

Skirting light

6811 50	Skirting Light, 2 module	356	1/10/50
---------	--------------------------	-----	---------

Indicator

6811 38	Flat Indicator Red, 1 module	110	1/20/200
---------	------------------------------	-----	----------

Allzy Mechanisms White

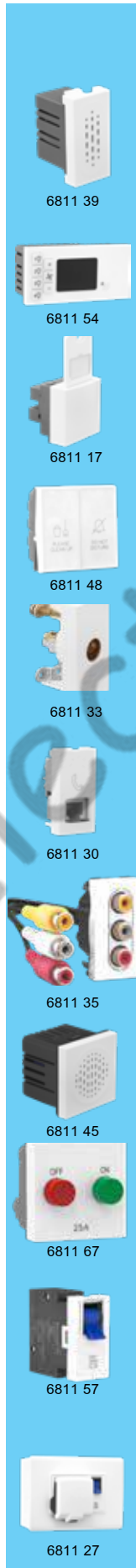

Cat.Nos	Description	MRP* ₹ / Unit	Pack
---------	-------------	------------------	------

Bell call indicator

6811 46	Bell call indicator, 1 module	619	1/20/100
---------	-------------------------------	-----	----------

Buzzer

6811 39	Buzzer 230V, 1 module	324	1/20/200
---------	-----------------------	-----	----------

Remote unit

6811 54	Remote Control Unit for Light & Fan, 4 module	6328	1/5/20
---------	---	------	--------

Hospitality Function Hotel keycard switch

6811 17	32A DP Key tag switch (Mechanical), 2 module	451	1/10
6811 47	Key card 16A switch with Card 230V, 2 module	2182	1/10

Hotel "DND and MMR" functions

6811 48	DND & MMR (Inside), 2 module	297	1/10/100
6811 49	DND & MMR indicator with 6A bell push (Outside), 2 module	333	1/10/100

Shaver socket

6811 55	Shaver Socket 120/230V AC with plate, 4 module	4095	1/5/20
---------	--	------	--------

Sockets and connectors TV sockets

6811 33	TV socket, 1 module	104	1/20/200
---------	---------------------	-----	----------

Data & voice

6811 30	RJ11 Telephone socket (with shutter), 1 module	110	1/20/200
6811 31	Double RJ11 Telephone socket (with shutter), 1 module	161	1/20/200
6811 32	RJ45 Cat6 UTP Socket (with shutter), 1 module	590	1/20/200

Audio video connectors

6811 34	Preterminated HDMI socket, 1 module	1139	1/10
6811 35	Preterminated Audio Video Connector, 1 module	1135	1/10
6811 36	Preterminated Projector Connector, 1 module	1479	1/10

Sound (Electronic Bell)

6811 45	Electronic Bell, 2 module	269	1/10/100
---------	---------------------------	-----	----------

Protectors and accessories Motor starter

6811 66	16A Motor starter, 2 module	509	1/10/100
6811 67	25A Motor starter, 2 module	509	1/10/100

Modular MCB (IS : 608981:2002)

6811 56	6A MCB SP C Curve, 1 module	382	1/10/100
6811 57	10A MCB SP C Curve, 1 module	382	1/10/100
6811 58	16A MCB SP C Curve, 1 module	382	1/10/100
6811 59	20A MCB SP C Curve, 1 module	382	1/10/100
6811 60	25A MCB SP C Curve, 1 module	382	1/10/100
6811 61	32A MCB SP C Curve, 1 module	382	1/10/100
6811 62	16A MCB DP C Curve, 2 module	724	1/10/100
6811 63	20A MCB DP C Curve, 2 module	724	1/10/100
6811 64	25A MCB DP C Curve, 2 module	724	1/10/100
6811 65	32A MCB DP C Curve, 2 module	724	1/10/100

Power Unit

6811 18	16A Power Unit, AC & Geyser, 4 module	491	1/5
6811 27	Power Unit with 20A MCB & 16A Plug, 3 module	1128	1/10
6811 28	Power Unit with 25A MCB & 16A Plug, 3 module	1207	1/10

Allzy Electronic Function

Cat.Nos	Description	MRP* ₹ / Unit	Pack
---------	-------------	------------------	------

USB chargers (IS13252 (Part 1) / IEC 60950-1)

6811 52	USB Charger 1500mA Type A, 1 module	850	1/10/100
6811 71	USB Charger 1500mA Type C, 1 module	1023	1/10/100
6811 51	Double USB Charger 3100mA Type A, 2 module	1358	1/10/100
6811 70	Double USB Charger 3100mA Type A & Type C, 2 module	1649	1/10/100

Combi (Socket + USB)

6811 72	Combi Twin USB 3100mA Type A with Euro US socket, 2 module	1679	1/10/100
6811 73	Combi Twin USB 3100mA Type A & Type C with Euro US socket, 2 module	2239	1/10/100
6811 53	Combi Twin USB 3100mA Type A with Multistandard socket, 3 module	2021	1/5/50
6811 20	Combo 6A Multistandard Switched Socket with USB Charger 3100mA Type A, 1 Gang, 2 module	2498	1/10

Accessories

6811 68	Cable outlet 0.8mm, 1 module	87	1/20/200
6811 69	Blanking plate, 1 module	26	1/40/400

Mechanisms Matt Black

Switches 6 A 230 V AC

6812 00	6A switch 1 way, 1 module	51	1/20/200
6812 11	6A switch 2 way, 1 module	115	1/20/200
6812 02	6A switch 1 way with indicator, 1 module	99	1/20/200
6812 03	6A switch 1 way with "light" marking, 1 module	104	1/20/200
6812 04	6A switch 1 way with "fan" marking, 1 module	103	1/20/200

Switches 16 A 230 V AC

6812 01	16A switch 1 way, 1 module	137	1/20/200
6812 12	16A switch 2 way, 1 module	198	1/20/200
6812 05	16A switch 1 way with indicator, 1 module	180	1/20/200

Switches 20A 230V AC

6812 07	20A switch 1 way, 1 module	168	1/20/200
6812 08	20A switch 1 way with indicator, 1 module	222	1/20/200
6812 13	20A SP switch 1 way with indicator, 2 module	248	1/10/100
6812 15	20A DP switch, 1 way, with indicator, 2 module	250	1/10/100

Switches 25 A 230 V AC

6812 06	25A switch 1 way with indicator, 1 module	226	1/20/200
---------	---	-----	----------

Switches 32 A 230 V AC

6812 16	32A DP switch with indicator, 2 module	336	1/10/100
---------	--	-----	----------

Bell Push button 6 A 230 V AC

6812 09	6A bell push 1 way, 1 module	111	1/20/200
6812 10	6A bell push 1 way with indicator, 1 module	137	1/20/200
6812 14	6A bell push 1 way with indicator, 2 module	210	1/10/100

Socket 240 V AC

6812 24	6A 3 pin Round socket with shutter, (ISI mark), 2 module	179	1/20/200
6812 22	6/16A socket with shutter, (ISI mark), 2 module	240	1/10/100
6812 26	25A socket with shutter, 2 module	267	1/10/100
6812 29	6A Multistandard Switched Socket, 1 Gang, 2 module	1031	1/10
6812 19	6A Multistandard Switched Socket, 2 Gang, 4 module	1954	1/5/20

Allzy Mechanisms Matt Black

Cat.Nos	Description	MRP* ₹ / Unit	Pack
---------	-------------	------------------	------

Dimmers and fan regulators

6812 43	Rotary Dimmer 400W, 1 module	503	1/5/50
6812 44	Rotary Dimmer 500W, 2 module	653	1/10/100
6812 40	Fan Regulator 4 step 100W (ISI mark), 1 module	500	1/5/50
6812 41	Fan Regulator 360 degree 100W (ISI mark), 2 module	571	1/10/100
6812 42	Fan Regulator 8 step 100W, 2 module	643	1/10/100

Skirting light

6812 50	Skirting Light, 2 module	408	1/10/50
---------	--------------------------	-----	---------

Indicator

6812 38	Flat Indicator Red, 1 module	124	1/20/200
---------	------------------------------	-----	----------

Buzzer

6812 39	Buzzer 230V, 1 module	368	1/20/200
---------	-----------------------	-----	----------

Remote unit

6812 54	Remote Control Unit for Light & Fan, 4 module	7214	1/5/20
---------	---	------	--------

Hospitality Function

Hotel keycard switch

6812 17	32A DP Key tag switch (Mechanical), 2 module	515	1/10
6812 47	Key card 16A switch with Card 230V, 2 module	2739	1/10

Hotel "DND and MMR" functions

6812 48	DND & MMR (Inside), 2 module	373	1/10/100
6812 49	DND & MMR indicator (Outside) with 6A bell push, 2 module	419	1/10/100

Shaver socket

6812 55	Shaver Socket 120/230V AC with plate, 4 module	4671	1/5/20
---------	--	------	--------

Sockets and connectors

TV sockets

6812 33	TV socket, 1 module	118	1/20/200
---------	---------------------	-----	----------

Data & voice

6812 30	RJ11 Telephone socket (with shutter), 1 module	124	1/20/200
6812 31	Double RJ11 Telephone socket (with shutter), 1 module	183	1/20/200
6812 32	RJ45 Cat6 UTP Socket (with shutter), 1 module	689	1/20/200

Audio video connectors

6812 34	Preterminated HDMI socket, 1 module	1297	1/10
6812 35	Preterminated Audio Video Connector, 1 module	1295	1/10
6812 36	Preterminated Projector Connector, 1 module	1683	1/0/10

Protectors and accessories

Motor starter

6812 66	16A Motor starter, 2 module	582	1/10/100
6812 67	25A Motor starter, 2 module	582	1/10/100

Modular MCB (IS : 608981:2002)

6812 56	6A MCB SP C Curve, 1 module	435	1/10/100
6812 57	10A MCB SP C Curve, 1 module	435	1/10/100
6812 58	16A MCB SP C Curve, 1 module	435	1/10/100
6812 59	20A MCB SP C Curve, 1 module	435	1/10/100
6812 60	25A MCB SP C Curve, 1 module	435	1/10/100
6812 61	32A MCB SP C Curve, 1 module	435	1/10/100



6811 52



6811 71



6811 73



6811 53



6811 20



6811 68



6811 69



6812 00



6812 11

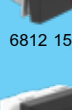

6812 02



6812 03



6812 04

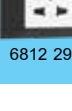

6812 01



6812 43



6812 44



6812 40



6812 41

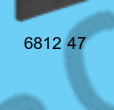

6812 42



6812 50



6812 38



6812 39



6812 54



6812 17



6812 47

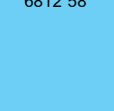

6812 49

Allzy Protectors and accessories

Cat.Nos	Description	MRP* ₹ / Unit	Pack
---------	-------------	------------------	------

Power Unit

6812 18	16A Power Unit ,AC & Geyser, 4 module	558	1/5
6812 27	Power Unit with 20A MCB & 16A Plug, 3 module	1285	1/10
6812 28	Power Unit with 25A MCB & 16A Plug, 3 module	1378	1/10

Electronic Function

USB chargers (IS13252 (Part 1) / IEC 60950-1)

6812 52	USB Charger 1500mA Type A, 1 module	1067	1/10/100
6812 71	USB Charger 1500mA Type C, 1 module	1163	1/10/100
6812 51	Double USB Charger 3100mA Type A, 2 module	1576	1/10/100
6812 70	Double USB Charger 3100mA Type A & Type C, 2 module	1878	1/10/100

Combi (Socket + USB)

6812 72	Combi Twin USB 3100mA Type A with Euro US socket, 2 module	1954	1/10/100
6812 73	Combi Twin USB 3100mA Type A & Type C with Euro US socket, 2 module	2534	1/10/100
6812 53	Combi Twin USB 3100mA Type A with Multistandard socket, 3 module	2304	1/5/50
6812 20	Combo 6A Multistandard Switched Socket with USB Charger 3100mA Type A, 1 Gang, 2 module	2848	1/10

Accessories

6812 68	Cable outlet 0.8 mm, 1 module	99	1/20/200
6812 69	Blanking plate, 1 module	29	1/40/400

Plate & Frame

Allzy Plate Frame White

6813 00	White Plate + Frame 1 module	109	1/20/200
6813 01	White Plate + Frame 2 module	109	1/20/200
6813 02	White Plate + Frame 3 module	150	1/10/100
6813 03	White Plate + Frame 4 module	160	1/10/100
6813 04	White Plate + Frame 6 module	220	1/5/50
6813 05	White Plate + Frame 8 module	269	1/5/50
6813 06	White Plate + Frame 4X2 module	269	1/5/25
6813 07	White Plate + Frame 9 module	315	1/5/50
6813 08	White Plate + Frame 12 module	388	1/10
6813 09	White Plate + Frame 16 module	416	1/10
6813 10	White Plate + Frame 18 module	443	1/10

Plate Frame Matt Black

6813 11	Matt Black Plate + Frame 1 module	136	1/20/200
6813 12	Matt Black Plate + Frame 2 module	136	1/20/200
6813 13	Matt Black Plate + Frame 3 module	180	1/10/100
6813 14	Matt Black Plate + Frame 4 module	205	1/10/100
6813 15	Matt Black Plate + Frame 6 module	282	1/5/50
6813 16	Matt Black Plate + Frame 8 module	312	1/5/50
681317	Matt Black Plate + Frame 4X2 module	312	1/5/25
6813 18	Matt Black Plate + Frame 9 module	375	1/5/50
6813 19	Matt Black Plate + Frame 12 module	453	1/10

Allzy Plate & Frame

Cat.Nos	Description	MRP* ₹ / Unit	Pack
---------	-------------	------------------	------

6813 20	Matt Black Plate + Frame 16 module	517	1/10
6813 21	Matt Black Plate + Frame 18 module	546	1/10

Plate Frame Gold

6813 33	Gold Plate + Frame 1 module	142	1/20/200
6813 34	Gold Plate + Frame 2 module	142	1/20/200
6813 35	Gold Plate + Frame 3 module	196	1/10/100
6813 36	Gold Plate + Frame 4 module	211	1/10/100
6813 37	Gold Plate + Frame 6 module	316	1/5/50
6813 38	Gold Plate + Frame 8 module	351	1/5/50
6813 39	Gold Plate + Frame 4X2 module	351	1/5/25
6813 40	Gold Plate + Frame 9 module	420	1/5/50
6813 41	Gold Plate + Frame 12 module	508	1/10
6813 42	Gold Plate + Frame 16 module	546	1/10
6813 43	Gold Plate + Frame 18 module	582	1/10

Plate Frame Aluminium Champagne

6813 44	Alu Champagne Plate + Frame 1 module	142	1/20/200
6813 45	Alu Champagne Plate + Frame 2 module	142	1/20/200
6813 46	Alu Champagne Plate + Frame 3 module	196	1/10/100
6813 47	Alu Champagne Plate + Frame 4 module	211	1/10/100
6813 48	Alu Champagne Plate + Frame 6 module	316	1/5/50
6813 49	Alu Champagne Plate + Frame 8 module	351	1/5/50
6813 50	Alu Champagne Plate + Frame 4X2 module	351	1/5/25
6813 51	Alu Champagne Plate + Frame 9 module	420	1/5/50
6813 52	Alu Champagne Plate + Frame 12 module	508	1/10
6813 53	Alu Champagne Plate + Frame 16 module	546	1/10
6813 54	Alu Champagne Plate + Frame 18 module	582	1/10

Plate Frame Rose Gold

6813 55	Rose Gold Plate + Frame 1 module	142	1/20/200
6813 56	Rose Gold Plate + Frame 2 module	142	1/20/200
6813 57	Rose Gold Plate + Frame 3 module	196	1/10/100
6813 58	Rose Gold Plate + Frame 4 module	211	1/10/100
6813 59	Rose Gold Plate + Frame 6 module	316	1/5/50
6813 60	Rose Gold Plate + Frame 8 module	351	1/5/50
6813 61	Rose Gold Plate + Frame 4X2 module	351	1/5/25
6813 62	Rose Gold Plate + Frame 9 module	420	1/5/50
6813 63	Rose Gold Plate + Frame 12 module	508	1/10
6813 64	Rose Gold Plate + Frame 16 module	546	1/10
6813 65	Rose Gold Plate + Frame 18 module	582	1/10

Surface Box

6813 70	Surface Box 8 module White	234	1/10
---------	----------------------------	-----	------

Britzy™ SWITCHES

THE
NO PROBLEM
SWITCH



ORANGE
CHROME

HERB
BEIGE

URBAN
BRONZE

WARM
ORANGE
SILVER

Now Available In
4 New Colours



Scan to know more about
the product.

Britzy™ SWITCHES

RANGE



Switch 6 A, 16 A



Switch 6 A two-way



Switch with indicator
6 A, 16 A, 25 A



Bell push with
indicator - 1 module



DP Switch 20 A, 32 A



Bell push with
indicator - 2 module



DND internal unit



DND external unit



6/16 A socket



Dimmer



Fan regulator
1 module



Fan regulator
2 module



USB charger
1 module



USB charger
2 module



RJ 45



RJ 11 Telephone socket



Double RJ 11
Telephone socket



Bell call indicator



TV socket



Skirting light



Buzzer



Key card Switch 16 A



Flat indicator red

Britzy™ switches

Cat.Nos	Description	MRP* ₹ / Unit	Pack
---------	-------------	------------------	------

Switches

- All switches are ISI marked as per latest IS 3854:1997
- Finger-proof terminal for protection against accidental contact
- Laser marking for easy identification

6734 01	6 A Switch SP 1 way 1 module	46	20/400
6734 02	6 A Switch SP 2 way 1 module	104	20/200
6734 03	6 A Switch SP 1 way with indicator 1 module	104	20/200
6734 11	16 A Switch SP 1 way 1 module	148	20/200
6734 12	16 A Switch SP 2 way 1 module	180	20/200
6734 13	16 A Switch SP 1 way with indicator 1 module	162	20/200
6734 24	25 A Switch SP 1 way with indicator 1 module	202	20/200
6734 25	20 A DP switch with indicator 2 modules	228	10/100
6734 26	32 A DP switch with indicator 2 modules	302	10/100

Push buttons

6734 04	6 A Bell push with indicator module 1	124	20/200
6734 06	6 A Bell push with indicator 2 module	188	10/100

Sockets

- Shuttered socket for child safety
- Shutter open only with phase and neutral insertion simultaneously

6734 55	6/16 A socket 3 Pin ISI 2 modules	208	10/100
6734 56	25 A socket 3 Pin 2 modules	232	10/100
6734 27	6A 3-Pin ISI Socket 2 module	120	1/20/200

Data & voice

6734 41	RJ11 telephone socket 1 module	110	20/200
6734 44	Double RJ11 telephone socket 1 module	162	20/200
6734 45	RJ45 Cat 6 computer socket 1 module	292	20/200

Television socket

6734 46	TV socket 1 module	104	20/200
---------	---------------------------	-----	--------

Buzzer

6734 40	Buzzer 230 V 1 module	336	20/200
---------	---------------------------------	-----	--------



Britzy™ switches

Cat.Nos	Description	MRP* ₹ / Unit	Pack
---------	-------------	------------------	------

Dimmer & regulator

6734 31	Fan regulator 100 W ISI 1 module	446	5/50
6734 30	Fan regulator 100 W ISI 2 modules	566	10/100
6734 33	Light dimmer 400 W 1 module	458	5/50
6734 38	Fan Regulator 8 Step 100 W 2 module	512	1/10/100

Bell indicator

6734 07	Bell call indicator 1 module	622	20/200
---------	------------------------------	-----	--------

Motor starter

6734 66	25 A Motor starter 2 modules	524	10/100
---------	--	-----	--------

Modular MCB (IS : 60898-1:2002)

6734 64	Modular SP MCB 16A	358	1/10/100
6734 61	Modular SP MCB 20A	358	1/10/100
6734 36	Modular SP MCB 25A	358	1/10/100
6734 37	Modular SP MCB 32A	358	1/10/100

USB Charger

6731 35#	USB Charger 1500mA Type A-1 module	924	10/100
6734 35	Double USB Charger 2000mA Type A-2 module	1224	5/50

Skirting light

6734 77	Skirting light 2 modules	444	5/50
---------	---------------------------------	-----	------

Indicator

6734 75	Flat indicator red 1 module	110	20/200
---------	------------------------------------	-----	--------

Key card switch

6734 80	16 A Key card switch 2 modules	2226	1/10
6734 83	Keyfob credit card size for 6734 80	162	1/10

Do Not Disturb indicator & internal control unit

6734 81	DND internal unit 2 modules	250	10/100
6734 82	DND external unit 2 modules	294	10/100

Accessories

6734 71	Cable outlet 1 module	90	20/200
6734 90	Blanking plate 1 module	28	20/200
6734 72	Blanking plate 2 modules	40	10/100

White plates with frame

Sleek and curvy plates with elegant looks comes with sturdy support frame for solid strength

6734 91	Plate & frame 86 x 86 1 module	86	20/200
6734 92	Plate & frame 86 x 86 2 modules	86	20/200
6734 93	Plate & frame 121 x 86 3 modules	120	10/100

* MRP - Maximum Retail Price Inclusive of all taxes including GST.
To be Introduced Shortly

Bold Cat.Nos are products normally available with Legrand (India) Stockists. Cat.Nos that are not bold - delivery within 4 - 8 weeks from the date of order. Bold packing quantity is our mandatory packing. Orders to be placed by Legrand (India) Stockist in multiples of the same.

Britzy™ Plates with frame

Cat.Nos	Description	MRP* ₹ / Unit	Pack
---------	-------------	---------------------	------

White plates with frame

Sleek and curvy plates with elegant looks comes with sturdy support frame for solid strength

6734 94	Plate & frame 146 x 86 4 modules	128	10/100
6734 96	Plate & frame 224 x 86 6 modules	168	5/50
6734 98	Plate & frame 245 x 86 8 modules	216	5/50
6734 95	Plate & frame 146 x 172 4 x 2 modules	216	5/25
6734 97	Plate & frame 224 x 172 12 modules	312	10
6734 99	Plate & frame 245 x 172 16 modules	336	10
6735 00	Plate & frame 224 x 240 18 modules	414	10



6734 96

WARM ORANGE SILVER plates with frame

6735 01	Plate & frame 86 x 86 1 module	144	20/200
6735 02	Plate & frame 86 x 86 2 modules	144	20/200
6735 03	Plate & frame 121 x 86 3 modules	180	10/100
6735 04	Plate & frame 146 x 86 4 modules	216	10/100
6735 05	Plate & frame 224 x 86 6 modules	300	5/50
6735 06	Plate & frame 245 x 86 8 modules	320	5/50
6735 07	Plate & frame 146 x 172 4 x 2 modules	388	5/25
6735 08	Plate & frame 224 x 172 12 modules	540	10
6735 09	Plate & frame 245 x 172 16 modules	728	10
6735 10	Plate & frame 224 x 240 18 modules	838	10



6735 03

HERB BEIGE plates with frame

6735 11	Plate & frame 86 x 86 1 module	144	20/200
6735 12	Plate & frame 86 x 86 2 modules	144	20/200
6735 13	Plate & frame 121 x 86 3 modules	180	10/100
6735 14	Plate & frame 146 x 86 4 modules	216	10/100
6735 15	Plate & frame 224 x 86 6 modules	300	5/50
6735 16	Plate & frame 245 x 86 8 modules	320	5/50



6735 13

Britzy™ Plates with frame

Cat.Nos	Description	MRP* ₹ / Unit	Pack
---------	-------------	---------------------	------

HERB BEIGE plates with frame

6735 17	Plate & frame 146 x 172 4 x 2 modules	388	5/25
6735 18	Plate & frame 224 x 172 12 modules	540	10
6735 19	Plate & frame 245 x 172 16 modules	728	10
6735 20	Plate & frame 224 x 240 18 modules	838	10

URBAN BRONZE plates with frame

6735 21	Plate & frame 86 x 86 1 module	144	20/200
6735 22	Plate & frame 86 x 86 2 modules	144	20/200
6735 23	Plate & frame 121 x 86 3 modules	180	10/100
6735 24	Plate & frame 146 x 86 4 modules	216	10/100
6735 25	Plate & frame 224 x 86 6 modules	300	5/50
6735 26	Plate & frame 245 x 86 8 modules	320	5/50
6735 27	Plate & frame 146 x 172 4 x 2 modules	388	5/25
6735 28	Plate & frame 224 x 172 12 modules	540	10
6735 29	Plate & frame 245 x 172 16 modules	728	10
6735 30	Plate & frame 224 x 240 18 modules	838	10



6735 23

ORANGE CHROME plates with frame

6735 31#	Plate & frame 86 x 86 1 module	144	20/200
6735 32#	Plate & frame 86 x 86 2 modules	144	20/200
6735 33#	Plate & frame 121 x 86 3 modules	180	10/100
6735 34#	Plate & frame 146 x 86 4 modules	216	10/100
6735 35#	Plate & frame 224 x 86 6 modules	300	5/50
6735 36#	Plate & frame 245 x 86 8 modules	320	5/50
6735 37#	Plate & frame 146 x 172 4 x 2 modules	388	5/25
6735 38#	Plate & frame 224 x 172 12 modules	540	10
6735 39#	Plate & frame 245 x 172 16 modules	728	10
6735 40#	Plate & frame 224 x 240 18 modules	838	10



6735 33

* MRP - Maximum Retail Price Inclusive of all taxes including GST.
To be Introduced Shortly

Bold Cat.Nos are products normally available with Legrand (India) Stockists. Cat.Nos that are not bold - delivery within 4 - 8 weeks from the date of order. Bold packing quantity is our mandatory packing. Orders to be placed by Legrand (India) Stockist in multiples of the same.

Britzy™ mounting boxes

Britzy™ SWITCHES

THE NO PROBLEM SWITCH



Guarantee

- The Company, at its discretion, will replace products if they have any manufacturing defect within 10 years for switches (without LED lamp) and power sockets. For all other Britzy™ wiring accessories the guarantee will be 2 years.
- The above guarantee is applicable when the devices are used in Legrand metal flush boxes. Otherwise the guarantee period will be reduced by 50%.
- The guarantee is only applicable when the products are installed as per the Company's instructions and not tampered in any manner.
- The guarantee states the Company's entire liability. It does not extend to cover consequential loss or damage or installation costs arising from defective products.

Cat.Nos	Description	MRP* ₹ / Unit	Pack
---------	-------------	---------------------	------

Flush mounting boxes - Metal

- Boxes are with top, bottom, side and back wall knockout for conduit entry from any direction
- Possible to break open knockout without any special tool

6890 60	Metal flush box 75.7 x 75.7 x 50.8 1 & 2 modules	72	40
6890 61	Metal flush box 98.9 x 75.7 x 50.8 3 modules	94	40
6890 62	Metal flush box 136 x 75.7 x 50.8 4 modules	116	40
6890 63	Metal flush box 213.4 x 75.7 x 50.8 6 modules	186	40
6890 64	Metal flush box 136.6 x 136.8 x 61 8 (2 rows x 4) modules	232	20
6890 65	Metal flush box 231.2 x 75.7 x 50.8 8 modules	232	40
6890 66	Metal flush box 215 x 145.3 x 61.2 12 (2 rows x 6) modules	322	10
6890 67	Metal flush box 232.8 x 147.4 x 61.2 16 (2 rows x 8) modules	364	10
6890 68	Metal flush box 215 x 213.3 x 61.2 18 modules	414	10

Surface mounting boxes - Plastic

6890 70	Plastic surface box 86 x 86 x 45 1 & 2 modules	62	10/50
6890 71	Plastic surface box 121 x 86 x 45 3 modules	80	5/35
6890 72	Plastic surface box 146 x 86 x 45 4 modules	104	5/25
6890 73	Plastic surface box 224 x 86 x 45 6 modules	154	1/10
6890 74	Plastic surface box 146 x 172 x 45 8 (2 rows x 4) modules	214	2/10
6890 75	Plastic surface box 245.2 x 86 x 45 8 modules	214	1/10
6890 76	Plastic surface box 224 x 172 x 45 12 (2 rows x 6) modules	260	1/10
6890 77	Plastic surface box 245.2 x 172 x 45 16 (2 rows x 8) modules	304	1/10

Surface mounting boxes - Metal

6890 78	Metal surface box 18 modules	320	1/10
---------	--	-----	------

* MRP - Maximum Retail Price Inclusive of all taxes including GST.
• To be Introduced Shortly

UX FOR UPSCALE HOTELS

FIVE STAR SOLUTION

Designed specifically for premium level establishments, UX for Upscale Hotels provides top quality solutions with its brand-new touchplates and enhanced functionalities. Operating on an open protocol, the guest room management system can seamlessly integrate with third party building management systems, thus raising hospitality to new heights across the world. In conjunction with Arteor or other Legrand wiring device ranges.

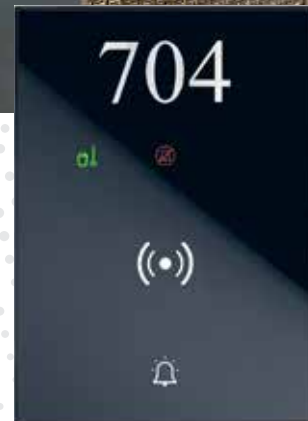
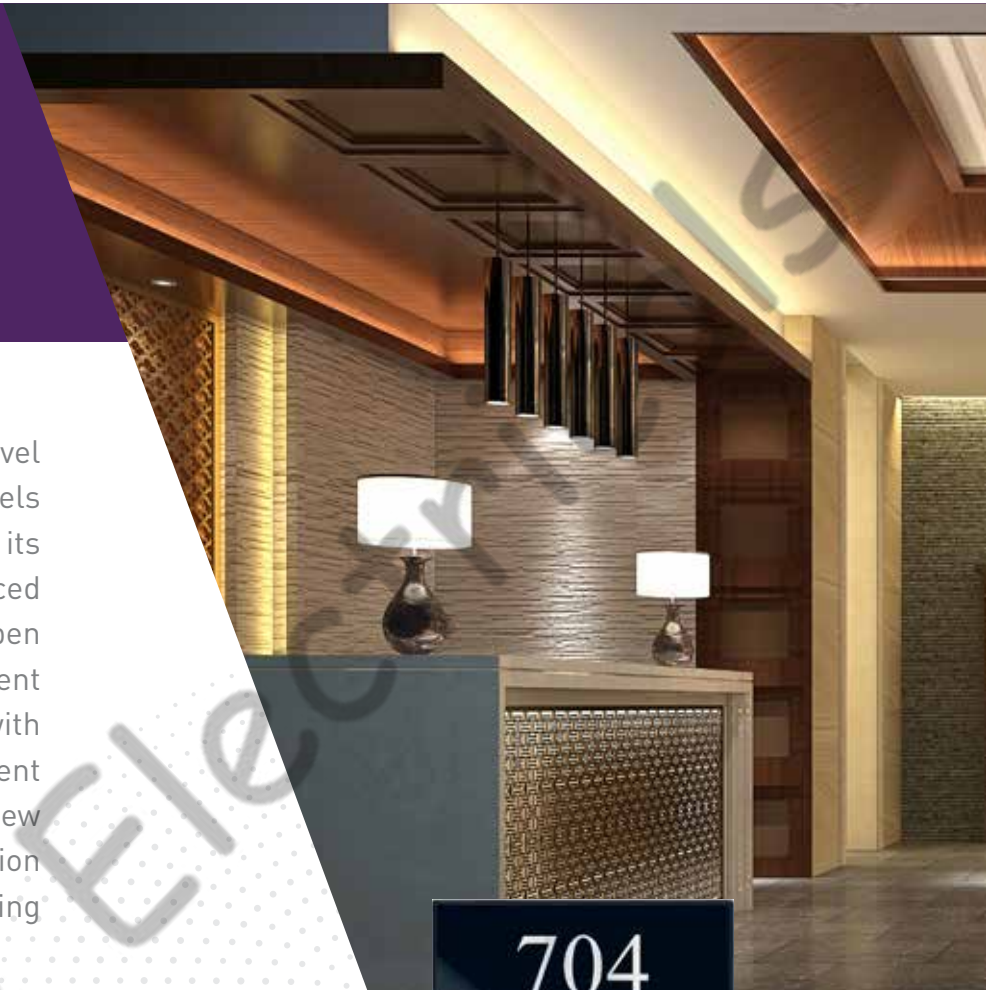

EXTERNAL READER



Scan to know more about
the product.

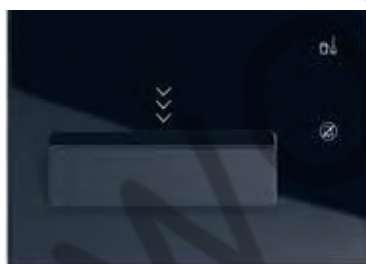
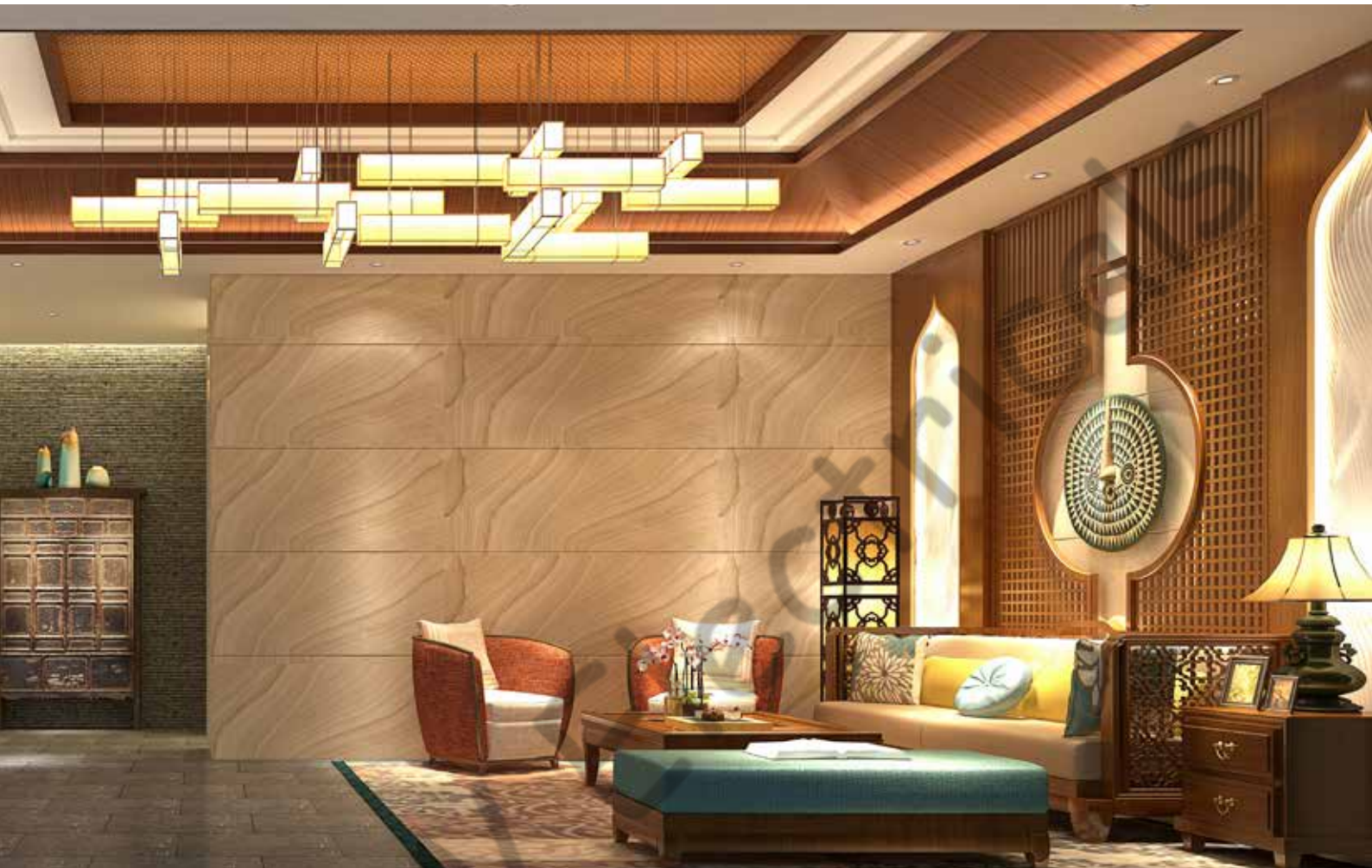

KEY CARD READER



6-GANG TOUCH PLATE



BEDSIDE PANEL

LIVING NOW IoT

REDEFINING SMART LIVING

State-of-the-art electric & digital infrastructures for the modern home.



Touch control



Control with
smartphone



Voice control



- **Innovative design:** revisited relationship between cover plate and functions.
- **Smart:** the first intrinsically connected wiring devices range!
- The best technical solutions for a **perfect installation.**



App
Home + Control



Scan to know more about
the product.

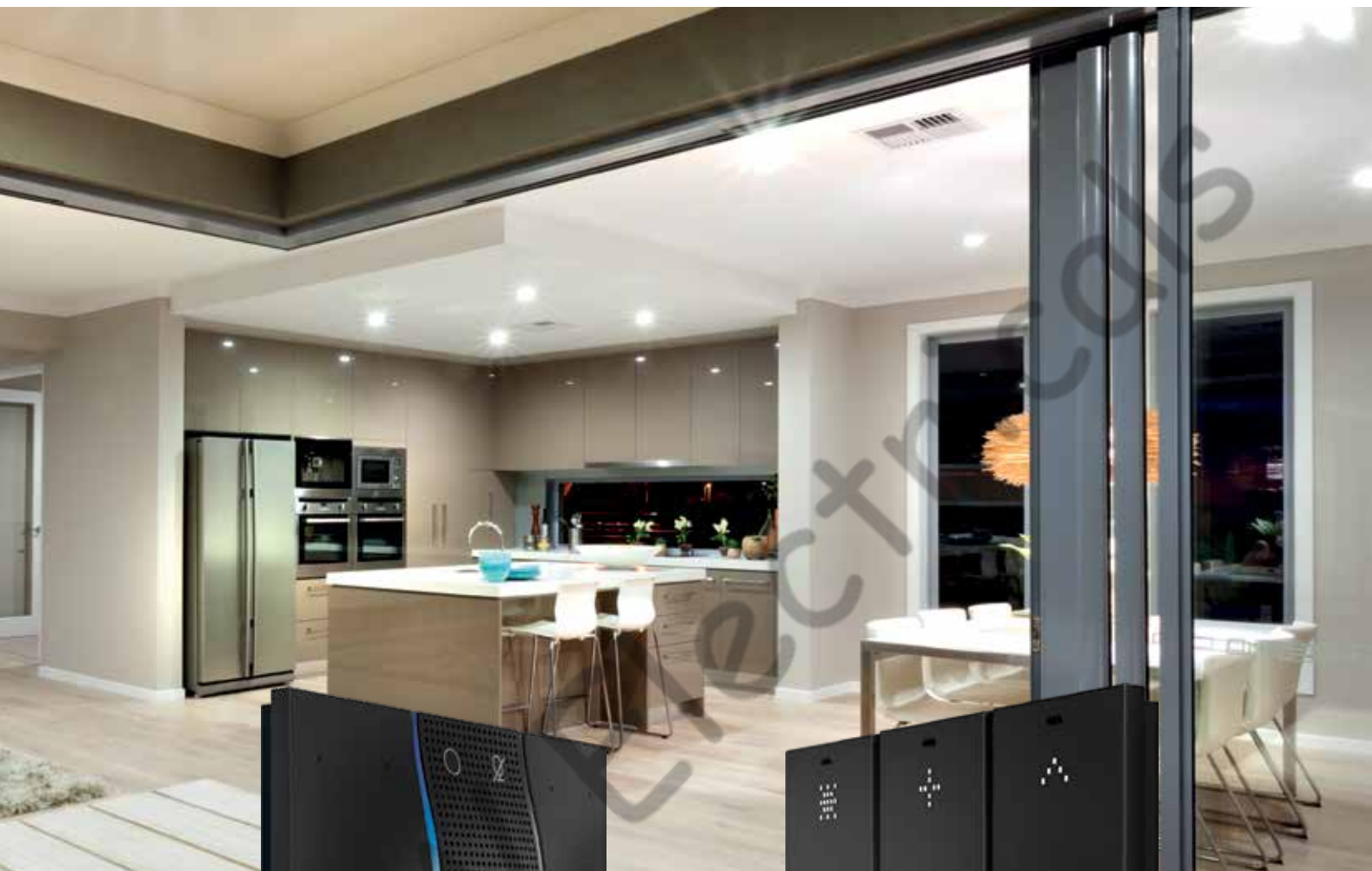

A TOUCH ABOVE THE REST

Mix of innovation and simplicity, ready to be discovered.



Living Now, has won this prestigious international award confirming Legrand's ability to combine technology and design.



WORKSTATION SOLUTIONS

POWER AND DATA DISTRIBUTION FOR THE OFFICE ENVIRONMENT

In order to guarantee convenience and performance for users in office buildings, workstations & different areas must be fitted with solutions that can be fully adjusted to different building infrastructures and still meet the user's connectivity and mobility needs.

These ranges of products are solutions for supplying and fitting out workstations in any kind of building infrastructure: Raised Floor, Flush Floor, Screed Floor & False Ceiling & Wall.



Pop-up boxes - for floor

Snap-On mini-columns

LEGRAND'S SOLUTION FOR DISTRIBUTING POWER AND DATA TO WORKSTATIONS

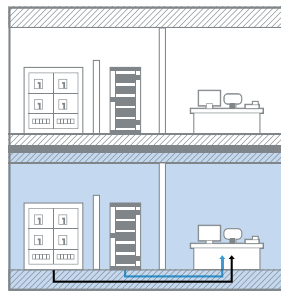

Work station solution supplied through the floor

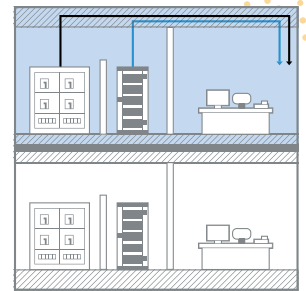

Work station solution supplied through the false ceiling & the wall



Scan to know more about the product.

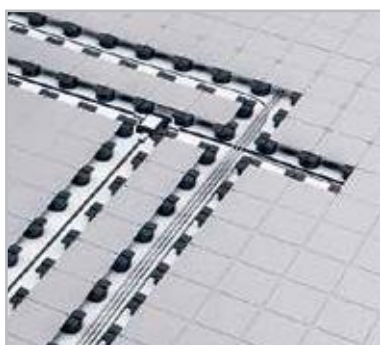

Soluflex cable floor system

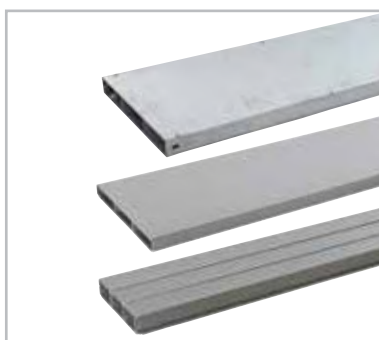

Raceways : PVC & Metal (GI)



Floor boxes



Pop- up Box



Power & data desk grommets



**Dlp trunking system:
Snap-on, Mini & PVC, Aluminium**



Cablofil wire mesh cable trays



Cable worm



Flush mounting power & data module

POWER AND DATA DISTRIBUTION & CONNECTION SOLUTIONS

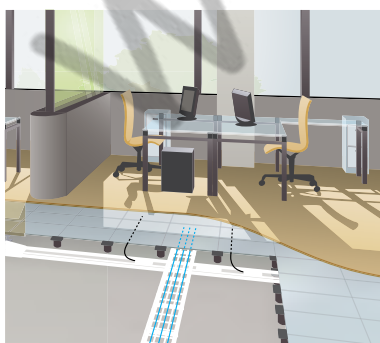

Raised access floor systems



Screed floor system

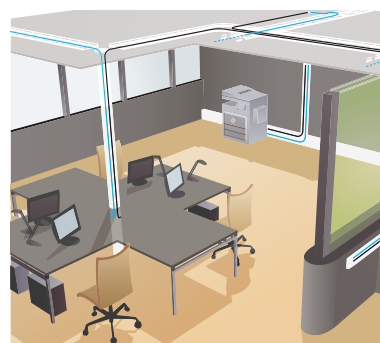

Wall and ceiling systems

CABLOFIL®

CABLOFIL IS THE MOST VERSATILE CABLE TRAY

Since its introduction 40 years ago, CABLOFIL has revolutionized Electrical and Telecommunication Cable support systems. CABLOFIL is one of the safest and most economical cable support systems available.

Made from welded steel wires, CABLOFIL meets the strictest of safety standards and satisfies the customer's need for reliability and fast economical installation.

Cablofil is a Full cable Management Solution

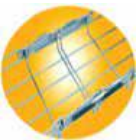

FAST -
Fast Coupling Solution Without Nuts And Bolts
Time Saving For More Economy

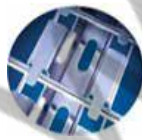

EASY-
Fixing Without Hardware On Profiles And Brackets
Secure By Bending The Fastening Tab
No More Nuts And Bolts



SECURE
For Cables
For Installers
For Installations
Natural Ventilation Of Cables
Cleanliness With No Retention Of Dust



AVAILABLE
2000 Items In Stock
8 Regional Hubs Worldwide
More Than 2000 Distributors
And our service with the same Quantity
For Products Are Available In More Than 60 Countries Around The World

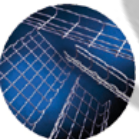

COMPLETE RANGE
For Every Environments
For Any Type Of Installations
For Any Type Of Activities



QUALITY
The most tested and Certified Cable Tray
The Most Specified Cable Tray In The World
40 Years Of Sales & Technical Assistance



ECONOMICAL
Cable Management Made On-Site
Time Saving, Forget About Specifics Development!
No More Specific Products For Derivations
No More Missing Products On-Site



PERFORMANCE
Maximum Strenth
Gauranteed Span Of 2 Meters
Between Supports
In Conformity With European And International Standards Cei/61537 & Vde/639



Scan to know more about the product.

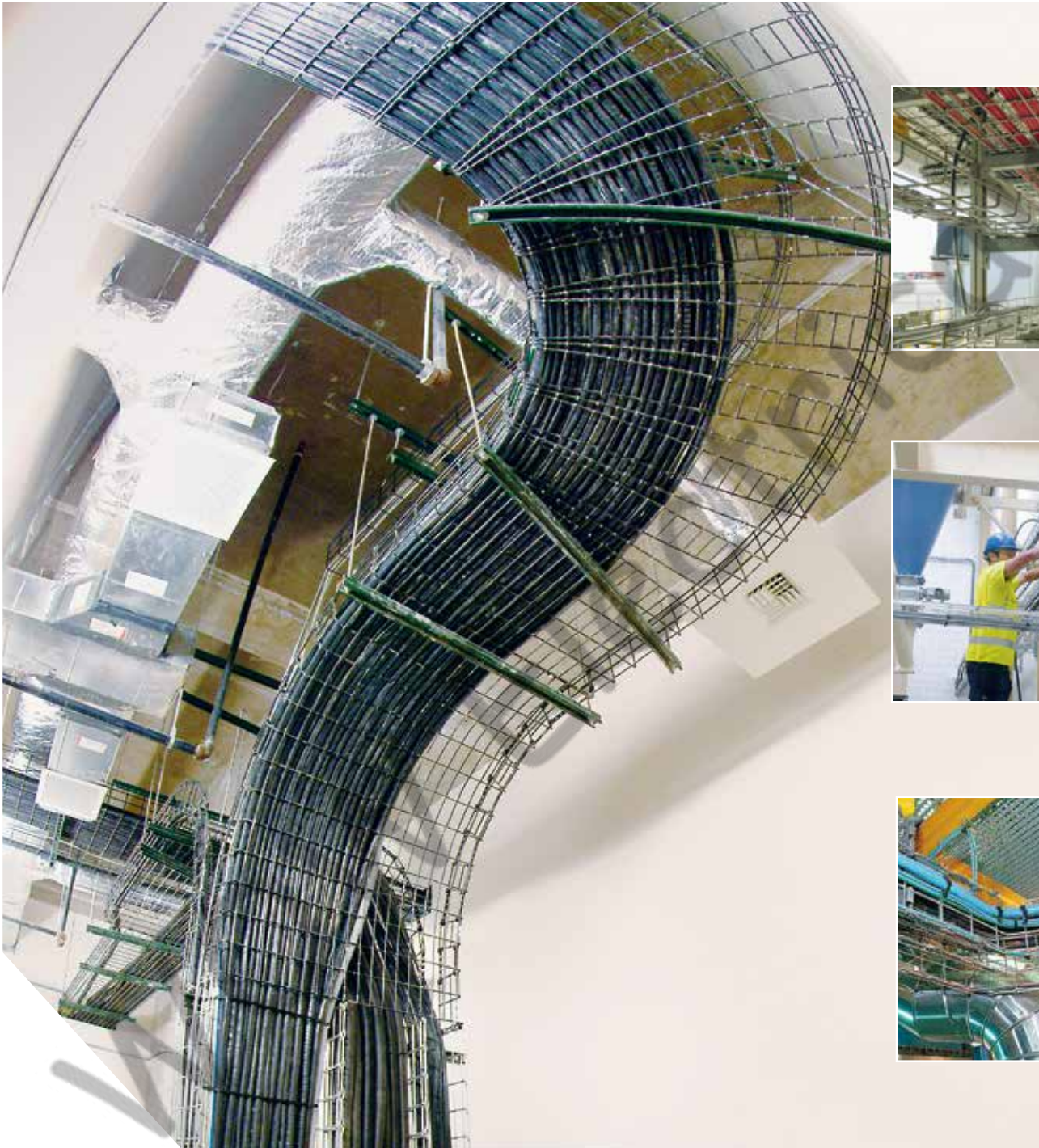

Raceways and junction boxes for screed floors

Cat.Nos	Description	MRP* ₹ / Unit	Pack
---------	-------------	------------------	------

Confirms to EN 50 085 - 2 - 2
Raceways are made from PVC and Galvanised sheet.
Compatible with Cat.6 structured cabling system.

Raceways - PVC

**Raceways - PVC - height 38 mm;
Standard length 2 meters⁽¹⁾; Price per meter**

0896 67	50 mm x 38 mm - 1 compartment	1324	12
0896 68	100 mm x 38 mm - 2 compartments	2440	16
0896 69	150 mm x 38 mm - 3 compartments	3732	10

Raceways - Metal / GI

**Raceways - Metal/GI - height 25 mm; length 2.44 m.
Price per unit (One unit is of 2.44 meters)**

6895 10	50 mm x 25 mm - 1 compartment	2314	3/54 ⁽¹⁾
6895 11	75 mm x 25 mm - 1 compartment	2982	3/21 ⁽¹⁾
6895 12	100 mm x 25 mm - 1 compartment	3620	3/54 ⁽¹⁾
6895 13	150 mm x 25 mm - 1 compartment	4916	3/18 ⁽¹⁾
6895 14	225 mm x 25 mm - 3 compartments	7708	3/12 ⁽¹⁾
6895 15	300 mm x 25 mm - 3 compartments	9726	3/18 ⁽¹⁾

**Raceways - Metal/GI - height 38 mm; length 2.44 m
Price per unit (One unit is of 2.44 meters)**

6895 00	50 mm x 38 mm - 1 compartment	2688	3/54 ⁽¹⁾
6895 01	75 mm x 38 mm - 1 compartment	3482	3/21 ⁽¹⁾
6895 02	100 mm x 38 mm - 1 compartment	4296	3/54 ⁽¹⁾
6895 03	150 mm x 38 mm - 1 compartment	5760	3/36 ⁽¹⁾
6895 04	225 mm x 38 mm - 3 compartments	8558	3/12 ⁽¹⁾
6895 05	300 mm x 38 mm - 3 compartments	10680	3/18 ⁽¹⁾

Raceways accessories

Fixing bracket (GI)

For fixing raceways (PVC & Metal) on the floor

6897 09	50 mm x 25 mm (metal)	36	9
6897 10	75 mm x 25 mm (PVC and metal)	60	9
6897 12	100 mm x 25 mm (metal)	68	9
6897 15	150 mm x 25 mm (metal)	88	9
6897 20	225 mm x 25 mm (metal)	122	9
6897 30	300 mm x 25 mm (metal)	162	9

Fixing bracket

6897 27	50 mm x 38 mm (PVC and metal)	40	9
6897 28	75 mm x 38 mm (metal)	70	9
6897 37	100 mm x 38 mm (PVC and metal)	82	9

Raceways and junction boxes for screed floors

Cat.Nos	Description	MRP* ₹ / Unit	Pack
---------	-------------	------------------	------

6897 38	150 mm x 38 mm (PVC and metal)	102	9
6897 25	225 mm x 38 mm (metal)	158	9
6897 35	300 mm x 38 mm (metal)	198	9

Riser

6897 23	Vertical - for 225 mm width raceways	2740	1
6897 33	Vertical - for 300 mm width raceways	3150	1

Coupler for joining raceways

6897 77	Coupling 38	162	6
6897 79	Coupling 25	122	6

Junction box

For direct access to cables at the intersection of raceways
Supplied completely with base and cover plate (Lid)

Height adjustable junction box 65 - 90 mm

6896 10	150 x 150 x 65 - 90 mm	3098	1
6896 11	225 x 225 x 65 - 90 mm	3840	1
6896 12	300 x 300 x 65 - 90 mm	4960	1
6896 13	400 x 400 x 65 - 90 mm	7652	1

Height adjustable junction box 65 - 90 mm with fly over

For direct access to cables at the intersection of floor raceways while maintaining perfect separation and 900 cross overs between data and power cables

6896 14	225 x 225 x 65 - 90 mm with flyover	4160	1
6896 15	300 x 300 x 65 - 90 mm with flyover	5642	1
6896 16	400 x 400 x 65 - 90 mm with flyover	8308	1

Optional site cover for junction box

6896 18	150 x 150 x 65 - 90 mm with metal cover	344	10
6896 19	225 x 225 x 65 - 90 mm with metal cover	486	10
6896 20	300 x 300 x 65 - 90 mm with metal cover	750	10
6896 21	400 x 400 x 65 - 90 mm with metal cover	1120	10

Height adjustable junction box 50 - 70 mm

6896 22	150 x 150 x 50-70 mm	2850	1
6896 23	225 x 225 x 50-70 mm	3502	1
6896 24	300 x 300 x 50-70 mm	4572	1
6896 25	400 x 400 x 50-70 mm	6986	1

* MRP - Maximum Retail Price Inclusive of all taxes including GST.
(1) Unit of measure in Nos
⁽¹⁾To be ordered in multiples of 2 meters

Bold Cat.Nos are products normally available with Legrand (India) Stockists.
Cat.Nos that are not bold - delivery within 4 - 8 weeks from the date of order.
Bold packing quantity is our mandatory packing. Orders to be placed by Legrand (India) Stockist in multiples of the same.

Floor boxes for carpet for raised floor, screed floor

Cat.Nos	Description	MRP* ₹ / Unit	Pack
---------	-------------	------------------	------

Floor boxes for raised floor

6896 38	Full backbox for raised floor - 3 compartments (264x264 mm) height 86 mm (for ducting upto 225 mm).	4872	1
6896 31	Lid & trim Grey cover RAL 7031 for 3 compartment floor box with flexible cable exits Size 265 mm x 265 mm	3604	5

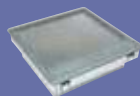

6896 38 +
6896 31

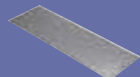

6896 62

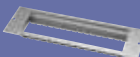

6896 17



6896 78



6896 34 +
6896 31

Support plates for floor boxes 77 mm width plate

6896 62	Blank plates for floor box	404	12
6896 17	Flat support plate 8 module for integration of Myrius mechanisms	412	1
6896 78	Waved support plates. For 4 modules (2 x 2 modules)	1222	4

Floor boxes for screed floor (3 Compartment)

6896 34*	Full backbox for screed floor 3 compartments (for ducting upto 225 mm). Height adjustable to screed height 65 to 90 mm	7400	1
6896 31*	Lid & trim Grey cover RAL 7031 for 3 compartment floor box with flexible cable exits. Size 265 mm x 265 mm	3604	5

Support plates for floor boxes 77 mm width plate

6896 62	Blank plates for floor box	404	12
6896 17	Flat support plate 8 module for integration of Myrius mechanisms	412	1
6896 78	Waved support plates for 4 modules (2x2 modules)	1222	4

Floor boxes for screed floor (4 Compartment)

6896 45	Full backbox for screed floor - 4 compartments (for ducting upto 300 mm) Height adjustable to screed height 65 to 90 mm. To be used with 6896 45	8390	1
6896 41	Lid & trim Grey cover RAL 1019 for 4 compartment floor box with flexible cable exits. To be used with 6896 41	4034	5

Support plates for floor boxes

77 mm width plate

6896 62	Blank plates for floor box	404	12
6896 17	Flat support plate 8 module for integration of Myrius	412	1
6896 78	Waved support plates For 4 Modules (2x2 Modules) mechanisms	1222	4

* MRP - Maximum Retail Price Inclusive of all taxes including GST.
6896 34 + 6896 31 with support plates and wiring devices

Floor boxes for tile / marble

Cat.Nos	Description	MRP* ₹ / Unit	Pack
---------	-------------	------------------	------

Stainless steel insert for Lid

For a metal finish on lid
To be used instead of fitting carpet onto the Lid

6896 92	For 3 compartment floor boxes dimension : 245.5x210 mm	4538	1
---------	--	------	---

Floor boxes for tile / marble

for screed floor

0896 04	Backbox for screed floor; Screed thickness 65 to 90 mm (for ducting upto 225 mm).	6328	1
6896 52	Lid & trim for tiles / marble 15 to 22 mm thickness Stainless steel material AISI 304. 2 cable outlet	31616	1
6896 55	Lid & Trim for tile 8-15 mm thickness Material for head band & single cable outlet - galvanised steel + paint RAL 7031	8668	1

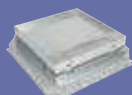

0896 04 +
6896 56

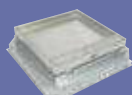

0896 04 +
6896 52

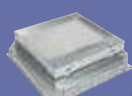

0896 04 +
6896 55

Support plates for floor boxes

77 mm width plate

6896 62	Blank plates for floor box	404	12
6896 17	Flat support plate 8 module for integration of Myrius	412	1
6896 78	Waved support plates For 4 Modules (2x2 Modules) mechanisms	1222	4

50 mm reduced height floor boxes

0880 73	Back box for Concrete Floor (to be used with 0880 70) (for ducting upto 225x25 mm)	9342	1
0880 70	Lid and Trim for Screed Floor between 50 and 70 mm. With Cover for carpet; grey RAL 7031 Can be equipped with SS finishing plate 0880 72 16 Module	9226	1
0880 72	Stainless steel finishing plate for 50 mm floor box	5856	1

NEW!

Lids and trims for floor box

0880 00	8/12 modules - Cat.Nos 0 880 20/23/39	2300	1
0880 01	12/18 modules - Cat.Nos 0 880 21/24/40	3070	1
0880 02	16/24 modules - Cat.Nos 0 880 22/25/41	3840	1
0880 03	8/12 modules - Cat.Nos 0 880 20/23/39	26130	1
0880 04	12/18 modules - Cat.Nos 0 880 21/24/40	27630	1
0880 05	16/24 modules - Cat.Nos 0 880 22/25/41	29410	1



0880 02



0880 05

Bold Cat.Nos are products normally available with Legrand (India) Stockists. Cat.Nos that are not bold - delivery within 4 - 8 weeks from the date of order. Bold packing quantity is our mandatory packing. Orders to be placed by Legrand (India) Stockist in multiples of the same.

Universal floor box

NEW!

Support kits for floor boxes

To be equipped with Arteor sockets

Equipped with support frames for wiring accessories

For sockets in horizontal position - adjustable height

For concrete floors, use auto-adjusting backboxes Cat.Nos 0 880 90/91/92 or universal adjustable backbox Cat.No 0 880 80 and adaptors Cat.Nos 0 880 81/82/83

Cat.Nos	Description	MRP* ₹ / Unit	Pack
0880 20	12 (3 x 4) modules	3840	1
0880 21	18 (3 x 6) modules	4860	1
0880 22	24 (3 x 8) modules	6390	1
0880 23	8 (2 x 4) modules	3070	1
0880 24	12 (2 x 6) modules	2560	1
0880 25	16 (2 x 8) modules	2560	1



NEW!

Universal adjustable back box

0880 80	Screed height: 55 to 125 mm	15350	1
---------	-----------------------------	-------	---

NEW!

Mounting adaptors for concrete floor

0880 81	8/12 modules Cat.Nos 0 880 20/30/23/39 and 0 881 20/23/39	3320	1
0880 82	12/18 modules Cat.Nos 0 880 21/31/24/40 and 0 881 21/24/40	3590	1
0880 83	16/24 modules Cat.Nos 0 880 22/32/25/41 and 0 881 22/25/41	3840	1

Auto-Adjusting back box

Screed height: 65 to 90 mm

For floor boxes (standard or flush version)

NEW!

0880 90	8/12 modules Cat.Nos 0 880 20/30/23/39 and 0 881 20/23/39	4860	1
0880 91	12/18 modules Cat.Nos 0 880 21/31/24/40 and 0 881 21/24/40	5890	1
0880 92	16/24 modules Cat.Nos 0 880 22/32/25/41 and 0 881 22/25/41	6910	1



Universal floor box

NEW!

Finishing plates

For plastic lids and trims - stainless steel finish

0880 15	8/12 modules	4510	1
0880 16	112/18 modules	4620	1
0880 17	16/24 modules	6270	1



NEW!

For metal lids and trims - stainless steel finish

0880 45	8/12 modules	6710	1
0880 46	12/18 modules	7700	1
0880 47	16/24 modules	8750	1



Heavy duty in-screed floor box

for screed floors

Metal in-screed floor box

0896 34	Universal metal in-screed backbox	26166	1
---------	-----------------------------------	-------	---



0896 34 +
0896 83 +
0896 85

Accessories for metal in-screed floor box

0896 83	Normal load support upto 8 KN load with deflection <6 mm	26658	1
0896 84	Heavy load support upto 20 KN load with deflection <3 mm	45072	1



0896 34 +
0896 83 +
0896 86 +
0896 87

Plates for metal in-screed floor boxes

77 mm width plate

0896 85	IP 66 plain cover (cover closed) access trap for junction. No cable exit	45500	1
---------	--	-------	---

Heavy duty in screed floor box with cable exit

0896 34	Metal in-screed floor box	26166	1
---------	---------------------------	-------	---







Accessories for metal in screed floor box

0896 83	Normal load support upto 8 KN load with deflection <6 mm	26658	1
0896 84	Heavy load support up to 20 KN load with deflection <3 mm	45072	1

Bold Cat.Nos are products normally available with Legrand (India) Stockists. Cat.Nos that are not bold - delivery within 4 - 8 weeks from the date of order. **Bold packing quantity** is our mandatory packing. Orders to be placed by Legrand (India) Stockist in multiples of the same.

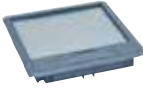
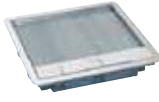
Standard version floor boxes for concrete floor

selection chart

SOCKET MOUNTING POSITION	CAPACITY	FLOOR BOX SUPPORT KITS	BACKBOXES		LIDS & TRIMS FLOORING THICKNESS ≤ 8 MM		FINISHING PLATES (OPTIONAL)		
			AUTO-ADJUSTING BACKBOX FOR SCREED HEIGHT UP TO 90 MM	UNIVERSAL ADJUSTABLE BACKBOX FOR SCREED HEIGHT UP TO 125 MM					
			 0 880 91	 0 880 80	 0 880 02	 0 880 05	 0 880 47		
 H min: 80 mm	12 (3 x 4) modules	0 880 20	0 880 90 ⁽¹⁾ screed height ≥ 80 mm	0 880 80 + 0 880 81 screed height ≥ 100 mm	Plastic	0 880 00	ST steel ⁽²⁾	0 880 15	
	18 (3 x 6) modules	0 880 21	0 880 91 ⁽¹⁾ screed height ≥ 80 mm	0 880 80 + 0 880 82 screed height ≥ 100 mm	Metal	ST steel ⁽²⁾	0 880 03	ST steel ⁽²⁾	0 880 45
					Plastic	0 880 01	ST steel ⁽²⁾	0 880 16	
24 (3 x 8) modules	0 880 22	0 880 92 ⁽¹⁾ screed height ≥ 80 mm	0 880 80 + 0 880 83 screed height ≥ 100 mm	Plastic	0 880 02	ST steel ⁽²⁾	0 880 17		
 H: 96 mm	12 (3 x 4) modules	0 880 30	-	0 880 80 + 0 880 81	Plastic	0 880 00	ST steel ⁽²⁾	0 880 15	
	18 (3 x 6) modules	0 880 31	-	0 880 80 + 0 880 82	Metal	ST steel ⁽²⁾	0 880 03	ST steel ⁽²⁾	0 880 45
					Plastic	0 880 01	ST steel ⁽²⁾	0 880 16	
24 (3 x 8) modules	0 880 32	-	OR 0 880 80 + 0 880 83	Plastic	0 880 02	ST steel ⁽²⁾	0 880 17		
 H min: 68 mm	8 (2 x 4) modules	0 880 23	0 880 90	OR 0 880 80 + 0 880 81	Plastic	0 880 00	ST steel ⁽²⁾	0 880 15	
	12 (2 x 6) modules	0 880 24	0 880 91	OR 0 880 80 + 0 880 82	Metal	ST steel ⁽²⁾	0 880 03	ST steel ⁽²⁾	0 880 45
					Plastic	0 880 01	ST steel ⁽²⁾	0 880 16	
16 (2 x 8) modules	0 880 25	0 880 92	0 880 80 + 0 880 83	Plastic	0 880 02	ST steel ⁽²⁾	0 880 17		
					Metal	ST steel ⁽²⁾	0 880 05	ST steel ⁽²⁾	0 880 47

1: Not possible to use straight plugs - 2: Stainless Steel finish

MOUNTING PRINCIPLE

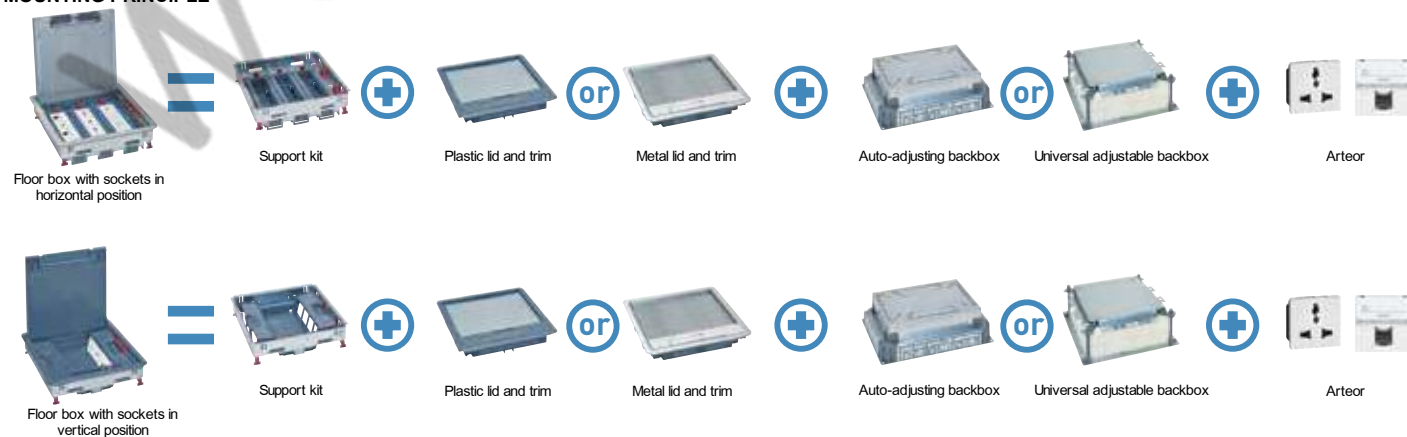

POP-UP BOXES

Our sleek new ergonomically designed pop-up boxes provide real ease of use and rapid connection solutions for mobile applications such as PCs, mobile phones, audio and video systems.



SLEEK DESIGN

Extra-slim format to blend discreetly into the office furniture or floor



Scan to know more about the product.



SAFETY AND EASE OF USE

Soft opening cover with damper and push & slide locking system



ELEGANT FINISHES

Aluminium, bronze, stainless steel, black or white - a perfect match for furniture and decor



FUNCTIONALITY AND FLEXIBILITY

Available in 3, 2x3, 4 and 2x4 modules for custom configuration or ready assembled with low and high current functions

Heavy duty in-screed floor box for screed floors

Cat.Nos	Description	MRP* ₹ / Unit	Pack
---------	-------------	------------------	------

Plates for metal in-screed floor boxes

0896 86	IP 66 plate (cover closed and plugs not connected) with central cable exit	92784	1
0896 87	IP 14 Cable exit accessory for IP66 cover plate Cat.No 0896 86 be used as a simple access to the floor void	49578	-

Over floor trunking

Conform to Std EN 50085-2-2; For creating a link between trunking, column, mini-column, floor units or protecting cables on passageways Supplied with cover

0300 92	Over floor trunking 50 x 12 mm; length 2 m, supplied with cover; 3 Compartments;	622	54 ⁽¹⁾
0300 11	Flat angle/floor 50 x 12	246	10
0300 12	Cover joint/floor 50 x 12	310	10
0300 93	Over floor trunking 75 x 18 mm; length 2 m, supplied with cover; 3 compartments;	846	36 ⁽¹⁾
0300 18	Flat angle/floor 75 x 18	470	10
0300 19	Cover joint/floor 50 x 12	328	10
0328 00	Over floor trunking 92 x 20 mm; Length 2 m, supplied with cover; 4 Compartments, equipped with 2 adhesive strips for better floor fixing	1552	20 ⁽¹⁾
0328 07	End cap for floor duct 92 x 20	274	10
0328 03	Cover joint for floor duct 92 x 20	376	10
0328 02	Flat angle for floor duct 92 x 20	678	5

Floor boxes 3 module for screed floor and raised floor

Floor service outlet boxes - 3 modules

0896 44	Floor service outlet box - 3 modules Grey RAL 7031 To be equipped with Arteor Mechanism	1992	1
0896 49	Flush mounting box for concrete for Cat.No 0896 44	1328	1

IP 66 Floor box - 4 module

Conform to EN 60670-1 and EN 60670-23 standards (when lid is closed) / IP55 (with cable exit accessory Cat.No 0880 62)

0880 61	IP66/IK09 screwed stainl. steel floor box (with removable lid); can be equipped with cable exit accessory Cat. No 0880 62	21724	1
0880 64	IP66/IK09 hinged cover stainl. steel floor box	25640	1

Floor boxes 3 module for screed floor and raised floor

Cat.Nos	Description	MRP* ₹ / Unit	Pack
---------	-------------	------------------	------

IP 66 Floor box - 4 module

Conform to EN 60670-1 and EN 60670-23 standards (when lid is closed) / IP55 (with cable exit accessory Cat.No 0880 62)

0880 69	Auto adjustable back box for installing IP66 floor boxes in concrete floors; supplied with cover; accepts conduit dia 20 mm; min screed height 65 mm	4172	1
0880 62	IP55 cable exit accessory	24200	1

Floor access unit for raised floors

IP 20 - IK 08

0893 07	Access master box floor box that can be used as a simple access to the floor void	9300	1
---------	---	------	---

Pop-up type flush-mounting boxes for floor

Pop-up boxes to be equipped

Equipped with "push and slide" locking system to avoid accidental opening by feet
To be equipped with Arteor socket outlets
For installation use the flush-mounting boxes for concrete floors or the kits for raised access floors

3 modules

0540 10	Matt aluminium finish	2908	1
0540 15	Brushed brass	4230	1
0540 20	Brushed Stainless steel finish	4280	1

4 modules

0540 11	Matt aluminium finish	3896	1
0540 16	Brushed brass	5010	1
0540 21	Brushed Stainless Steel finish	5422	1
0540 26	Matt black	4898	1
0540 31	Glossy white	5014	1

6 (2 x 3) modules

0540 12	Matt aluminium finish	6522	1
0540 17	Brushed brass	9080	1
0540 22	Brushed stainless steel finish	9418	1

8 (2 x 4) modules

0540 13	Matt aluminium finish	8076	1
0540 18	Brushed brass	10898	1
0540 23	Brushed stainless steel finish	11590	1
0540 28	Matt black	10502	1
0540 33	Glossy white	10564	1

Retractable accessory for Pop Up

0540 34	RJ45 Cat 6 UTP retractable Kit - 1 module	4052	1
0540 35	RJ45 Cat 6 FTP retractable Kit - 1 module	5666	1
0540 36	USB/ Micro-USB Retractable Kit - 1 module	3838	1

* MRP - Maximum Retail Price Inclusive of all taxes including GST.
(1) Price in Meters; No of meters in Pack, Standard length 2 meters to be ordered in multiple of 2 meters.

Bold Cat.Nos are products normally available with Legrand (India) Stockists. Cat.Nos that are not bold - delivery within 4 - 8 weeks from the date of order. Bold packing quantity is our mandatory packing. Orders to be placed by Legrand (India) Stockist in multiples of the same.

Pop-up type flush-mounting boxes for floor

Cat.Nos	Description	MRP* ₹ / Unit	Pack
---------	-------------	------------------	------

Installation kits for raised access floors

Include an empty receptacle and fixing brackets for raised access floor tiles Compatible with:
- Cat. 6 data cabling
- Audio/video cabling

0540 05	3 modules	1328	1
0540 06	4 modules	1592	1
0540 07	6 (2 x 3) modules	2206	1
0540 08	8 (2 x 4) module	2718	1



0540 06

For installation of pop-up floor boxes in concrete floors

Equipped with knockouts for ø 20 and ø 25 mm conduits

Metal flush-mounting boxes

0540 00	3 modules	356	1
0540 01	4 modules	474	1
0540 02	6 (2 x 3) modules	754	1
0540 03	8 (2 x 4) modules	944	1



0540 00

Pop-up type flush-mounting boxes for furniture

Pop-up boxes to be equipped

Slim design for perfect integration into the furniture
To be equipped with Arteor socket outlets
Supplied alongwith installation kits for table top

4 modules

6540 14	Matt Aluminium	3816	1
6540 00	Matt steel finish	5098	1
6540 01	Glossy White	4718	1
6540 02	Matt Black	4514	1



6540 00

8 (2 x 4) modules

6540 15	Matt Aluminium	7908	1
6540 03	Matt steel finish	11032	1
6540 04	Glossy White	10042	1
6540 05	Matt Black	9984	1

Power & data desk grommets for workstation & meeting room table application

Empty power & data desk grommets

To be equipped with Arteor socket outlets, Easily retro fitted into a 60 to 80 mm diameter hole in current office desks and workspace table tops (by replacing the desk grommet)
Cover opens to 180° angle to prevent breaking

For one 2P+E socket

0540 70*	White RAL 9003, to be equipped with 1 socket	2820	1
0540 71*	Black RAL 9017, to be equipped with 1 socket	2764	1

0540 70
+ 0540 60

For one 2P+E socket and USB phone charger

Supplied with one USB phone charger output

5 V= 750 mA, to be wired

0540 72*	White RAL 9003 with USB, to be equipped with 1 socket	6734	1
0540 73*	Black RAL 9017 with USB, to be equipped with 1 socket	7338	1



0540 73

0540 73
+ 0540 62

* MRP - Maximum Retail Price Inclusive of all taxes including GST.

* Finishing Plates to be ordered separately

Red Cat.Nos - new products

Power & data desk grommets for workstation & meeting room table application

Cat.Nos	Description	MRP* ₹ / Unit	Pack
---------	-------------	------------------	------

Pre-wired modules with retractable cords

For fitting on an empty power & data desktop modules (under the table top)
Automatic cable rewind when not connected, for an optimized use of the desk surface

Cat. 6 FTP

0540 65	Equipped with - 1.35 m RJ 45 Cat. 6 FTP retractable cord on the user side and - 1 x RJ 45 socket on the installation side Patch cord for connection to data network to be ordered separately	4120	1
---------	--	------	---



0540 65

USB / micro USB

0540 67	Equipped with - 1.35 m retractable cord with micro USB connector, on the user side and - 0.5 m cable with USB connector on the installation side	3730	1
---------	--	------	---



0540 67

Finishing plates for empty power & data desk grommets

For fitting on an empty power & data desk grommets

0540 60	White RAL 9003	406	10
0540 62	Black RAL 9017	450	10
0540 63	Stainless steel	1636	10



0540 60



0540 62

Cable worm

0535 98	2 compartments, Length: 0.75 m White colour very suitable solution for a safe and design protection of the cabling between desk and floor	6444	1
---------	---	------	---



0535 98

Flush mounting power and data module

A ready to embed solution for all dry support with thickness between 2 and 40 mm. Conform to standard NFC 61-314 which ensures safety of the user
Aesthetic product (no visible screw), thickness of 6mm only.
Product available in 8 and 12 module, with the option of configuring power sockets, data, AV, protection etc. 3 Finishes; white/ black and aluminium

Flush mounting power and data module to be equipped

Aluminium extensions with cable guide (reversible)
To be equipped with Arteor sockets

8 module; length - 180 mm

0535 60	Flush 8 mod white finish	7322	1
0535 61	Flush 8 mod aluminium finish	8642	1
0535 62	Flush 8 mod black finish	7134	1



0535 60

12 module; length - 270 mm

0535 63	Flush 12 mod white finish	7706	1
0535 64	Flush 12 mod aluminium finish	9282	1
0535 65	Flush 12 mod black finish	7774	1

Bold Cat.Nos are products normally available with Legrand (India) Stockists. Cat.Nos that are not bold - delivery within 4 - 8 weeks from the date of order. Bold packing quantity is our mandatory packing. Orders to be placed by Legrand (India) Stockist in multiples of the same.

DLP-S

UNIVERSAL TRUNKING

FOR THE ESSENTIALS

- Traditional installation method with modular or with universal supports
- Compatible with all types of 45 mm mechanisms (like Arteor)

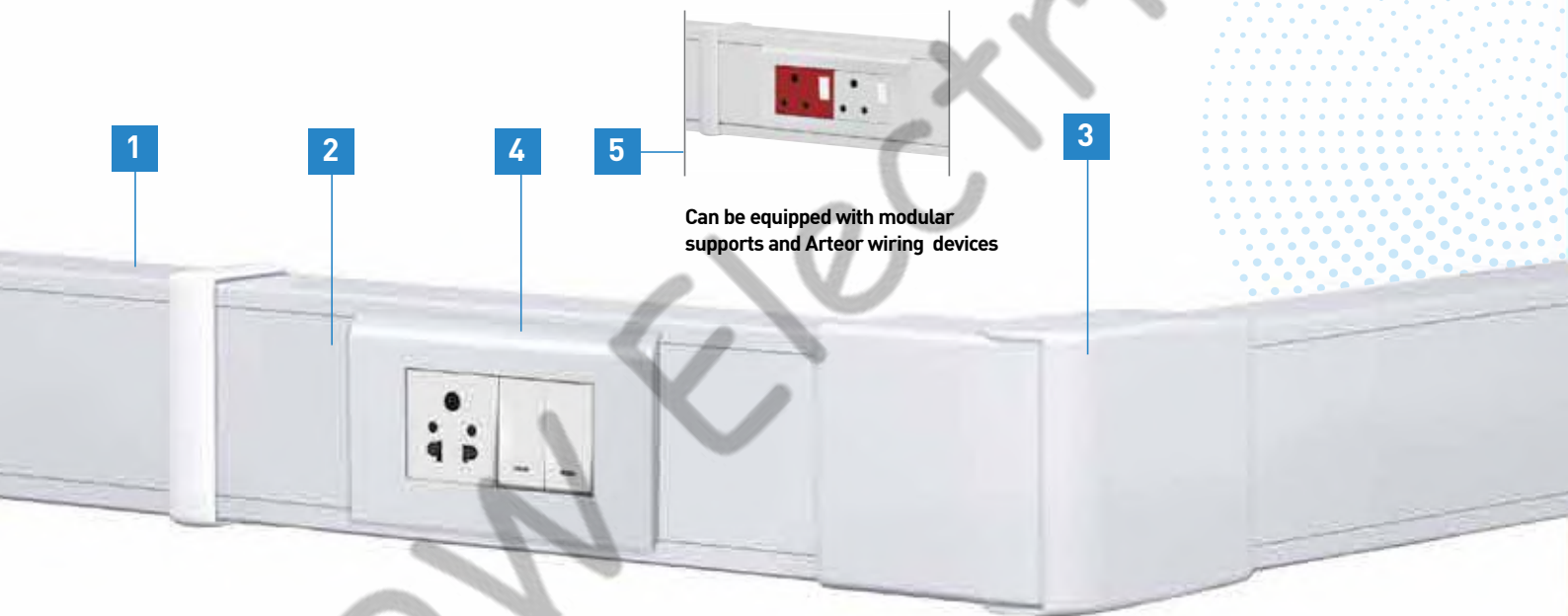

1 Rigid profiles with perforations



2 Self-guiding cover

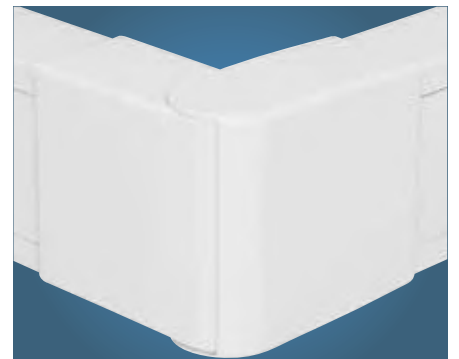

3 Ready to install accessories



Scan to know more about the product.



4 Myrius single module switch with brackets



5 Arteor sockets and modular support

snap-on trunking

routing sections and accessories

TRUNKING			TRUNKING		
Number of compartments	Cover width	Cross-section (mm)	Monobloc: body + cover ¹⁾	Divider	Fishplate body joint
SNAP-ON TRUNKING - 45 mm cover					
	45	50 x 80	○ 0756 01	0756 09	0756 61
	45	50 x 105	0756 02	0756 09	0756 62
	45 45	50 x 130	0756 03	-	0756 61
	45 45	50 x 145	0756 04	-	0756 63
	45 45 45	50 x 180	0756 06	-	0756 61

1: Partition(s) integral to the body
2: Internal and external corner angles supplied with multi-compartment partition joint

mechanisms for snap-on trunking

Mounting functions		
<p>The Arteor sockets to be fitted with Soluclip accessory which has following features:</p> <ul style="list-style-type: none"> - Anti-slip - Anti-pullout - IP 4X - Perfect finish 		0756 90

Installation principle for sockets for snap-on trunking

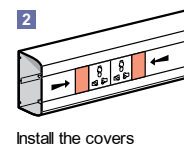
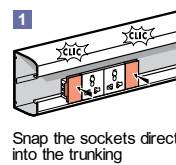

Installation principle for Arteor functions

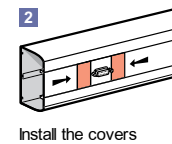
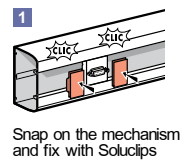

AND ACCESSORIES			ANGLES			JUNCTIONS				ACCESSORIES
Stick-on body joint	Cover joint	End cap	Internal angles ⁽²⁾	External angles	Flat angles	Flat junctions with width 80 mm	Flat junctions with width 105 mm	Angled junctions 85/105/130 mm	Junction with floor duct 50 x 12/ 92 x 20	Extra cover
0756 66	0756 69	0756 11	0756 21	0756 31	0756 41	0756 71	-	0756 81 + 0756 21	0756 88	0756 08
0756 67	0756 69	0756 12	0756 22	0756 32	0756 42	0756 72	0756 76	0756 81 + 0756 22	0756 88	0756 08
0756 66	2 x 0756 69	0756 13	0756 23	0756 33	0756 43	0756 71	0756 75	0756 81 + 0756 23	0756 88	0756 08
① 0756 66 + ② 0756 67	2 x 0756 69	0756 14	0756 24	0756 34	0756 44	① 0756 71 + ② 0756 72	① 0756 75 + ② 0756 76	0756 81 + 0756 24	0756 88	0756 08
0756 66	3 x 0756 69	0756 16	0756 26	0756 36	0756 46	0756 71	0756 75	0756 81 + 0756 26	0756 88	0756 08

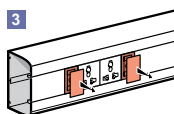

3 Disengage the finishing piece

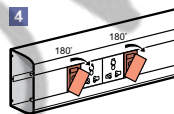

4 Rotate the finishing piece by 180°

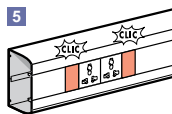

5 Snap on the finishing piece

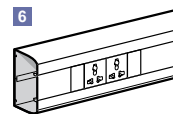

6 An impeccable result

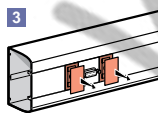

3 Disengage the finishing piece

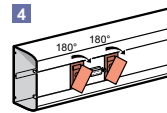

4 Rotate the finishing piece by 180°

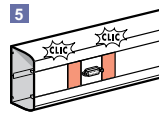



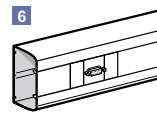























5 Snap on the finishing piece







6 An impeccable result

DLP PVC adaptable trunking systems for installations base, covers, partitions, finishing accessories and mounting wiring accessories

Selection chart for Installation of trunking, Accessories and Arteor™

Trunking			Covers		Clip on partition		Arteor™ frames				
Number of compartments	Cover(s) width	Section (mm)									
			Flexible	Partitions separation	Plastic	Aluminium	1 module	2 module	3 module	4 module	6 module
 0104 12	1 1 x 65 	80 x 50	0105 21	0105 82	-	-	-	0109 52	0109 53	0109 54	0109 56
 0104 22	1 1 x 85 	105 x 50	0105 22	0105 82	-	-	-	0109 92	0109 93	0109 94	0109 96
	2 2 x 40 		0105 20	0105 82	0104 72	0111 06	0109 10	-	-	-	-
 0104 32	1 1 x 130 	150 x 50	0105 24	0105 82	-	-	-	-	-	-	-
	2 2 x 65 		0105 21	0105 82	0104 72	0111 06	-	0109 52	0109 53	0109 54	0109 56
	2 1 x 40 + 1 x 85 		0105 20 + 0105 22	0105 82	0104 72	0111 06	0109 10	0109 92	0109 93	0109 94	0109 96
	3 3 x 40 		0105 20	0105 82	0104 72 x 2	0111 06 x 2	0109 10	-	-	-	-
 0104 52	1 1 x 180 	195 x 50	0105 26	0105 82	-	-	-	-	-	-	-
	2 2 x 85 		0105 22	0105 82	0104 72	0111 06	-	0109 92	0109 93	0109 94	0109 96
	2 1 x 40 + 1 x 130 			0105 82	0104 72	0111 06	0109 10	-	-	-	-
	3 1 x 85 + 2 x 40 			0105 82	0104 72 x 2	0111 06 x 2	0109 10	0109 92	0109 93	0109 94	0109 62
	3 1 x 40 + 2 x 65 			0105 82	0104 72 x 2	0111 06 x 2	0109 10	0109 52	0109 53	0109 54	0109 56
	4 4 x 40 			0105 20	0105 82	0104 72 x 3	0111 06 x 3	0109 10	-	-	-

Selection chart for Installation trunking, Accessories and Arteor™

Section (mm)	Wall crossing 	Capacity change 	Partition junction 	Cable tie base 	Insulating unit for Arteor™ modules 	Earth Link
					2 Module Combined to get 4/6 Module	
80 x 50 / 105 x 50	0106 98	0106 87 + 0106 88 + 0106 89 (to be used for partition)	0106 89	0308 81	0109 27	0111 88
150 x 50 / 195 x 50	0106 99					

Selection chart for Installation of trunking, Additional accessories

Cover	Bases		Internal angles 80° - 100°			External angles 60° - 120°			Flat angles		Flat junction			
Joint for covers	Base joint	End caps	Angles	Partition junction	VDI access.	Angles	Partition junction	VDI access.	Angles	VDI access.	Angles	Partition junction	VDI access.	Clips
0108 01	0106 91	0107 22	0106 02	-	0107 80	0106 22	-	0107 81	0107 67	0107 82	0107 32	-	0107 83	0106 82
0108 02	0106 91	0107 02	0106 02	-	0107 80	0106 22	-	0107 81	0107 85	0107 82	0107 32	-	0107 83	0106 82
0108 00	0106 91	0107 02	0106 02	0106 11	-	0106 22	0106 32	-	-	-	0107 32	0107 42	-	0106 82
0108 04	0106 91	0107 06	0106 02	-	-	0106 22	-	-	0107 89	-	0107 32	-	-	0106 86
0108 01	0106 91	0107 06	0106 02	0106 11	0107 80	0106 22	0106 32	0107 81	0107 89	0107 82	0107 32	0107 42	0107 83	0106 82
0108 02	0106 91	0107 06	0106 02	0106 11	0107 80	0106 22	0106 32	0107 81	0107 89	0107 82	0107 32	0107 42	0107 83	0106 82
0108 00	0106 91	0107 06	0106 02	0106 11 x 2	-	0106 22	0106 32 x 2	-	0107 89	-	0107 32	0107 42	-	0106 82
0108 06	0106 91	0107 07	0106 02	-	-	0106 22	-	-	0107 92	-	0107 32	-	-	0106 86
0108 02	0106 91	0107 07	0106 02	0106 11	0107 80	0106 22	0106 32	0107 81	0107 92	0107 82	0107 32	0107 42	0107 83	0106 82
	0106 91	0107 07	0106 02	0106 11	0107 80	0106 22	0106 32	0107 81	0107 92	0107 82	0107 32	0107 42	0107 83	
	0106 91	0107 07	0106 02	0106 11 x 2	0107 80	0106 22	0106 32 x 2	0107 81	0107 92	0107 82	0107 32	0107 42	0107 83	0106 82
	0106 91	0107 07	0106 02	0106 11 x 2	0107 80	0106 22	0106 32 x 2	0107 81	0107 92	0107 82	0107 32	0107 42	0107 83	0106 82
0108 00	0106 91	0107 07	0106 02	0106 11 x 3	-	0106 22	0106 32 x 3	-	0107 92	-	0107 32	0107 42	-	0106 82

DLP mini trunking systems for cable distribution





■ Selection chart for DLP mini trunking

	Length	Finishing Accessories				Junction Elements
WHITE	2 m	End cap	Internal angle	External angle	Flat angle	Flat junction
32 x 12.5	0300 15	0312 03	0302 51	0302 51	0302 53	0302 54
32 x 16	0308 04	0312 07	0333 25	0333 25	0333 27	0333 30
32 x 20	0300 17	0312 09	0302 71	0302 71	0302 73	0302 74

DLP aluminium trunking system

selection chart of sections, covers and accessories
selection chart of support for wiring accessories

TRUNKING AND ACCESSORIES

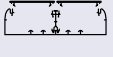
Width (mm)	Nos. of compartments	Covers width	Cat. nos.	Rigid covers 				 Cover Joint	 Trunking Base Joint
				65 mm width	85 mm width	130 mm width	180 mm width		
105 x 50	1 	1 x 85	111 00	-	0111 11	-	-	0111 63	0111 66
150 x 50	2 	2 x 65	0111 02	2 x 0111 10	-	-	-	0111 62	0111 66
195 x 50	2 	2 x 85	0111 04	-	2 x 0111 11	-	-	0111 63	0111 66

SUPPORT FOR WIRING ACCESSORIES

60 mm fixing centers : Arteur™		Cover depths	
No of module		65 mm	85 mm
2 modules		0112 02	0112 12
3 modules		0112 03	0112 13
4 modules		0112 04	0112 14
6 modules		0112 06	0112 16

Insulation resistance : the entire DLP range, including accessories, have insulation resistance above 5 Megaohms

DLP TRUNKING SYSTEM ALUMINIUM

with aluminium adaptable DLP trunking, get better styling too !



SELECTION CHART OF ACCESSORIES (continued)

Dividers		End cap	Internal angles	External angles	Flat angles	Junction Flat junction*	Clips	Earth link
Clip-on partition	Separation partition							
-	0111 08	0111 58	0112 21	0112 32	0112 43	0112 51	0106 82	0111 88
0111 06	0111 08	0111 60	0112 27	0112 38	0112 45	0112 51	0106 82	0111 88
0111 06	0111 08	0111 61	0112 29	0112 40	0112 47	0112 51	0106 82	0111 88

(1) To be used with angle covers. (2) To be used with rigid covers

TABLE OF CAPACITIES

	Crosssection (mm ²) Max. Ø (mm ²)	105 x 50	150 x 50		195 x 50	
		cover 85	cover 65	cover 65	cover 85	cover 85
Trunking only	Cross-section	4330	3020	3020	5350	5350
	Max. Ø	28	43	43	55	55
With Arteor / support	Cross-section	2300	1470	1470	3320	3320
	Max. Ø	2 x 24	18	18	33	33

*To tap off 105 mm wide trunking with 85 mm cover

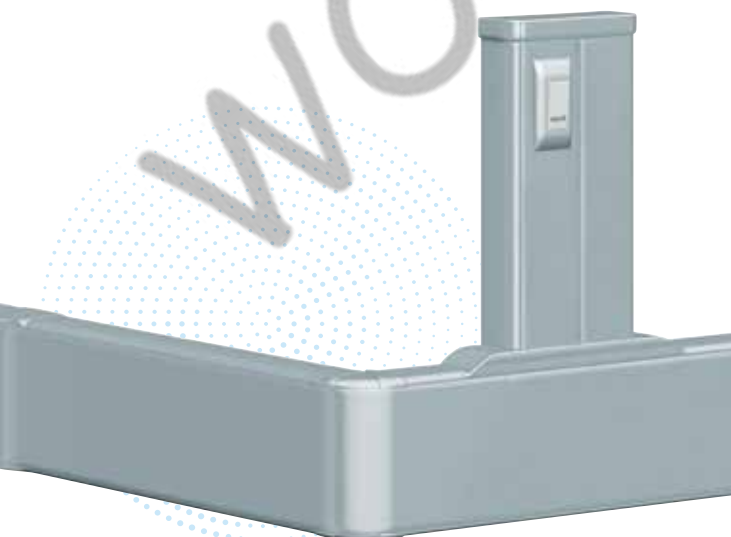

SAVE TIME

- Flexibility : multi-covers
- Removable separation
- Angles delivered pre-cut, ready to use
- Fast fixing device support
- Uniform colours for the entire installation
- Arteor™ wiring accessories go with aluminium adaptable DLP trunking

Snap-on trunking routing sections and accessories

Cat.Nos	Description	MRP* ₹ / Unit	Pack
---------	-------------	------------------	------

Snap-on trunking

Monobloc: Body + Cover, can take any Arteor wiring accessory
Standard length 2 meters; Price per meter

0756 01	Snap-on trunking 50 x 80 1 - compartment	1324	20 ⁽¹⁾
0756 02	Snap-on trunking 50 x 105 1 - compartment	1686	12 ⁽¹⁾
0756 03	Snap-on trunking 50 x 130 2 - compartments	2318	12 ⁽¹⁾
0756 04	Snap-on trunking 50 x 145 2 - compartments	2992	8 ⁽¹⁾
0756 06	Snap-on trunking 50 x 180 3 - compartments	3294	8 ⁽¹⁾

Divider

0756 09	Divider	292	26 ⁽¹⁾
---------	---------	-----	-------------------

Extra cover

0756 08	Width 45 mm	516	20 ⁽¹⁾
---------	-------------	-----	-------------------

Joints

Fishplate Body joint

0756 61	Set of 2 Body joints	466	10
0756 62	Set of 2 Body joints	618	10
0756 63	Set of 2 Body joints	542	10

Stick-on body joint

0756 66	For top part of body	302	20
0756 67	For bottom part of body	366	20

Cover joint

0756 69	Cover joint, width 45 mm	160	10
---------	--------------------------	-----	----

End caps

0756 11	Left or right end cap	270	10
0756 12	Left or right end cap	270	10
0756 13	Left or right end cap	448	5
0756 14	Left or right end cap	462	5
0756 16	Left or right end cap	504	5

Height spacer

0105 80	Colour charcoal grey for fitting 15 mm from the ground	680	24 ⁽¹⁾
---------	--	-----	-------------------

Soluclip accessory

Fishplate body joint

0756 90	For installation with any Arteor function	236	10
---------	---	-----	----

Angles

Internal angles

0756 21	varies from 80° to 100°	618	10
0756 22	varies from 80° to 100°	862	10
0756 23	varies from 80° to 100°	1448	5
0756 24	varies from 80° to 100°	2326	5
0756 26	varies from 80° to 100°	2058	5

External angles

0756 31	varies from 85° to 120°	1292	10
0756 32	varies from 85° to 120°	1974	10
0756 33	varies from 85° to 120°	2680	5
0756 34	varies from 85° to 120°	3160	5
0756 36	varies from 85° to 120°	3746	5

Flat angles

0756 41	Flat angle at 90°	756	10
0756 42	Flat angle at 90°	990	10
0756 43	Flat angle at 90°	1974	5
0756 44	Flat angle at 90°	1850	5
0756 46	Flat angle at 90°	3700	5

* MRP - Maximum Retail Price Inclusive of all taxes including GST.
(1) Price in Meters; No of meters in Pack, Standard length 2 meters to be ordered in multiples of 2 meters

Snap-on trunking routing sections and accessories

Cat.Nos	Description	MRP* ₹ / Unit	Pack
---------	-------------	------------------	------

Junctions

Flat junctions with 80 mm width

0756 71	Creates a junction	1034	5
0756 72	Creates a junction	1034	5

For 105 mm wide upward trunking

0756 75	Creates a junction	1012	5
0756 76	Creates a junction	1106	5

Angled junction

Must be used in conjunction with an internal angle

0756 81	Creates a junction in an internal angle	2282	5
---------	---	------	---

Junction with floor duct

0756 88	Creates a junction with a floor duct size 50 x 12 mm or 92 x 20 mm	1200	5
---------	--	------	---

DLP PVC trunking system

Mini-trunking system

Standard length 2 meters; Price per meter
Mini-trunking - 32 x 12.5 mm

0300 15	Without central partition	142	80 ⁽¹⁾
---------	---------------------------	-----	-------------------

Finishing accessories

0312 03	End cap right or left	78	20/400
0302 51	Changeable internal - external angle from 60° to 120°	106	10/100
0302 53	Changeable flat angle from 85° to 95°	118	10/100
0302 54	Flat junction	154	10/200
0336 03	White 32 x 10/12.5 Cover Joint	152	20

Mini-trunking - 32 x 16 mm

0308 04	Without central partition	186	60 ⁽¹⁾
---------	---------------------------	-----	-------------------

Finishing accessories

0312 07	End cap right or left	112	10
0333 25	Changeable internal - external angle from 60° to 120°	128	10
0333 27	Changeable flat angle from 85° to 95°	126	10
0333 30	Flat junction	176	10
0336 04	White 32 x 16/20 Cover Joint	152	20

Mini-trunking - 32 x 20 mm

0300 17	Without partition	202	50 ⁽¹⁾
---------	-------------------	-----	-------------------

Finishing accessories

0312 09	End cap right or left	160	10
0302 71	Changeable internal - external angle from 60° to 120°	154	10
0302 73	Changeable flat angle from 85° to 95°	128	10
0302 74	Flat junction	152	10
0336 04	White 32 x 16/20 Cover Joint	152	20

Bold Cat.Nos are products normally available with Legrand (India) Stockists. Cat.Nos that are not bold - delivery within 4 - 8 weeks from the date of order. Bold packing quantity is our mandatory packing. Orders to be placed by Legrand (India) Stockist in multiples of the same.

DLP PVC trunking system and accessories - trunking and fittings

Cat.Nos	Description	MRP* ₹ / Unit	Pack
---------	-------------	------------------	------

Standard length 2 meters; Price per meter Trunking

Bodies

Supplied without cover

0104 12	80 x 50 mm	822	20 ⁽¹⁾
0104 22	105 x 50 mm	1024	20 ⁽¹⁾
0104 32	150 x 50 mm	1734	10 ⁽¹⁾
0104 52	195 x 50 mm	2336	8 ⁽¹⁾

Flexible cover

Fits onto the whole branch including in internal or external angles

0105 20	Full covers width 40 mm	416	20 ⁽¹⁾
0105 21	Full cover width 65 mm	400	24 ⁽¹⁾
0105 22	Full cover width 85 mm	462	20 ⁽¹⁾
0105 24	Full cover width 130 mm	990	8
0105 26	Full cover width 180 mm	1264	8 ⁽¹⁾

Partitions

0105 82	Separation partition	274	24 ⁽¹⁾
0104 72	Clip-on partition - Plastic	400	48 ⁽¹⁾
0111 06	Clip-on partition - Aluminium	1630	12 ⁽¹⁾

Joints

0106 91	Body / Base joint - For aligning bases during installation	90	20/200
0108 00	Cover joint for 40 mm width	192	10/100
0108 01	Cover joint for 65 mm width	158	10/100
0108 02	Cover joint for 85 mm width	244	10/100
0108 04	Cover joint for 130 mm width	418	10/100
0108 06	Cover joint for 180 mm width	384	10/100

Angles and end caps

Internal and external angles

Include the 2 components for the top and bottom of the trunking on which the flexible cover is fitted

0106 02	Internal angle, adjustable from 80° to 100°	592	10/40
0106 22	External angle, adjustable from 60° to 120°	578	10/50

Flat angle

0107 67	90° flat angle	826	10
0107 85	90° flat angle	862	10
0107 89	90° flat angle	2860	5
0107 92	90° flat angle	3666	2

End cap

0107 02	Left or right end cap	210	20/100
0107 06	Left or right end cap	416	10/50
0107 07	Left or right end cap	492	5/50
0107 22	Left or right end cap	236	10

Junctions

0107 32	Flat junctions to tap-off to a branch smaller than 50 x 105	1064	10
0107 35	For specific size tap-off to 80 mm wide branch	620	5
0107 36	For tap-off to an 105 mm wide branch equipped with an 85 mm cover	616	5/25
0107 37	Flat junction for specific size - tap off to an 105 mm wide branch with 65 mm cover	616	5/25

* MRP - Maximum Retail Price Inclusive of all taxes including GST.
(1) Price in Meters; No of meters in Pack, Standard length 2 meters to be ordered in multiples of 2 meters

DLP PVC trunking system and accessories - trunking and fittings

Cat.Nos	Description	MRP* ₹ / Unit	Pack
---------	-------------	------------------	------

Junctions

Partition junction

0106 11	For internal angles	360	5/50
0106 32	For external angles	542	5/50
0107 42	For flat angles	1276	5/25

Accessories

Holding cables in place

0106 82	Clip for 65 mm width cover	80	50
0106 86	Clip for 130 mm width cover	136	50

VDI accessories

0107 80	For internal angles	922	5/50
0107 81	For external angles	994	5/50
0107 82	For flat angles	1058	5/50
0107 83	For flat junctions	1272	5/50

Additional accessories

0106 98	Wall crossing for trunking 80 to 150 mm width	1026	5/25
0106 99	Wall crossing for trunking 195 mm width	1064	5/25
0308 81	Cable tie base	34	100/1000
0111 88	Earthing link	392	20/500

Capacity Change

Allows to increase 15 mm height of trunking to preserve the space of wiring with a flat junction or a support equipment

0106 87	Raise, length 57 cm	372	40
0106 88	Set of 4 accessories to change capacity of the body	468	10/100
0106 89	Set of 2 accessories to change height of partition (to be used)	470	5/50

Supports for mounting wiring accessories

Arteor™ supports

To be equipped with Arteor socket outlets
Clip-on supports which can be fitted side by side
Supplied with finishing plate

0109 10	1 modules-for 40 mm cover	212	5/50
0109 52	2 modules-for 65 mm cover	206	20
0109 92	2 modules-for 85 mm cover	216	20
0109 53	3 modules-for 65 mm cover	286	5/50
0109 93	3 modules-for 85 mm cover	302	5/50
0109 54	4 modules-for 65 mm cover	322	10/50
0109 94	4 modules-for 85 mm cover	332	20
0109 56	6 modules-for 65 mm cover	342	5/25
0109 96	6 modules-for 85 mm cover	420	10
0109 27	Insulation unit for 2 modules (Arteor™) can be fitted together to create 4/6/8 module supports	362	10/100

Legrand Lexic supports

0109 25	For 2 modules for 65 mm cover (2 comp.)	1260	5
0109 35	For 3 modules for 85 mm cover (2 comp.)	1482	5
0109 65	For 6 modules for 130 mm cover (1 comp.)	1670	5
0109 00	Hypra socket support - for 130 mm cover	2426	5

Bold Cat.Nos are products normally available with Legrand (India) Stockists. Cat.Nos that are not bold - delivery within 4 - 8 weeks from the date of order. Bold packing quantity is our mandatory packing. Orders to be placed by Legrand (India) Stockist in multiples of the same.

DLP-S PVC trunking system and accessories - trunking and fittings

Cat.Nos	Description	MRP* ₹ / Unit	Pack
---------	-------------	------------------	------

Standard length 2 meters; Price per meter

Trunking

Body with cover

6380 38	100 x 50	1180	12 ⁽¹⁾
---------	----------	------	-------------------

Partition

6380 08	Separation Partition	224	32 ⁽¹⁾
---------	----------------------	-----	-------------------

Joints

6380 36	Body / Base Joint	74	10
6380 01	Cover joint	196	50

Angles and end caps

Variable angles

6380 31	Variable Internal Angle	462	10
6380 32	Variable External Angle	462	10

Fixed angles

6380 11	Fixed Internal Angle	300	20
6380 12	Fixed External Angle	302	20

Flat angle

6380 13	Flat Angle	656	16
---------	------------	-----	----

End cap

6380 35	End Cap	166	20
---------	---------	-----	----

Bracket

6380 05	Universal Bracket (set of 2 pcs.)	140	10/100
---------	-----------------------------------	-----	--------

Junction

6380 34	Tee / Flat Junction	1446	5
---------	---------------------	------	---

Supports for mounting wiring accessories

Arteor™ & Myrius supports

Clip-on supports which can be fitted side by side
Supplied with finishing plate

6380 71	2 modules frame	206	10
6380 72	4 modules frame	296	5
6380 73	6 modules frame	422	5

DLP aluminium adaptable trunking system

Body

Standard length 2 meters; Price per meter

0111 00	100 x 50 Supplied without cover	5224	8 ⁽¹⁾
0111 02	150 x 50 Supplied without cover allow fitting of partial covers - 2 compartments	6584	4 ⁽¹⁾
0111 04	195 x 50 Supplied without cover allow fitting of partial covers - 2 compartments	7720	4 ⁽¹⁾

Cover and partition

0111 10	Rigid cover 65 mm width	1312	16 ⁽¹⁾
0111 11	Rigid cover 85 mm width	1722	16 ⁽¹⁾
0111 08	Separation partition	902	24 ⁽¹⁾
0111 06	Clip on Partition	1630	12 ⁽¹⁾

Finishing accessories

0111 66	Base / Body joint	312	20/100
0111 62	Cover joint - 65 mm	428	10
0111 63	Cover joint - 85 mm	456	10/100
0111 58	End cap	930	20/100
0111 60	End cap	1990	10
0111 61	End cap	2362	10

* MRP - Maximum Retail Price Inclusive of all taxes including GST.
(1) Price in Meters; No of meters in Pack, Standard length 2 meters to be ordered in multiples of 2 meters

DLP aluminium adaptable trunking system - trunking and fittings

Cat.Nos	Description	MRP* ₹ / Unit	Pack
---------	-------------	------------------	------

Finishing accessories

0112 43	Flat angle for 85 mm cover	8004	10
0112 45	Flat angle for cover 65/130 mm	13476	5
0112 47	Flat angle for cover 85/180 mm	13902	2
0112 32	External angle for 85 mm cover	9978	1
0112 38	External angle 2 cover 65 mm	20664	1
0112 40	External angle 2 covers 85mm	21570	1
0112 21	Internal angle for 85 mm cover	8978	1
0112 27	Internal angle 2 Covers 65 mm	20514	1
0112 29	Internal angle 2 Cover 85 mm	21426	1
0112 51	Flat junction To tap off to 105 mm wide trunking equipped with 85 mm cover	10868	5

Supports for Arteor™ for cover 85 mm width

To be equipped with Arteor socket outlets

0112 12	2 modules	648	20
0112 13	3 modules	764	20
0112 14	4 modules	766	20
0112 16	6 modules	1022	10

Supports for Arteor™ for cover 65 mm width

To be equipped with Arteor socket outlets

0112 02	2 modules	590	20
0112 03	3 modules	724	20
0112 04	4 modules	754	20
0112 06	6 modules	884	10

Cabling accessories

0106 82	Clip for 65 mm and 85 mm covers	80	50
0111 88	Earth link	392	20
0308 81	Base for cable ties	34	100

Aluminium Snap-on Columns

2 Compartments mini - columns

	Can be equipped with ovaline kits Cat.Nos 6530 63/64/65		
6530 23	White finish PVC body and covers Height 0.68 m	14150	1
6530 24	Aluminium finish Aluminium body and covers Height 0.68 m	19976	1

Accessories for 1 or 2 compartments mini - columns

6530 84	Table - white finish	39124	1
6530 86	Movable foot - white finish	25804	1
6530 87	Movable foot - aluminum finish	27138	1
6530 88	Set of 4 wheels with cable holder	17810	1

Bold Cat.Nos are products normally available with Legrand (India) Stockists. Cat.Nos that are not bold - delivery within 4 - 8 weeks from the date of order. Bold packing quantity is our mandatory packing. Orders to be placed by Legrand (India) Stockist in multiples of the same.

Accessories for 1 or 2 compartments

NEW!

Cat.Nos	Description	MRP* ₹ / Unit	Pack
---------	-------------	------------------	------

Fixing clip

6038 57	Fixing clip - Signal White (Set of 2 pcs.)	296	10
6038 58	Fixing clip -Grey/Anthracite (Set of 2 pcs.)	834	10

1 Compartment - 2 sides columns

White finish

6530 10	Aluminium body, PVC covers Height 2.70m Can be adapted to a ceiling Height upto 3.9m	37128	1
6530 13	Height 3.9m Can be adapted to a ceiling Height upto 5.1m Aluminium body and covers	47778	1

Aluminium finish

6530 11	Height 2.70m Can be adapted to a ceiling Height up to 3.9m Height 3.9m	43282	1
6530 14	Can be adapted to a ceiling height up to 5.1m	54434	1

2 compartments columns

White finish

6530 30	PVC body & covers Height 2.70m Can be adapted to a ceiling Height upto 3.9m	35960	1
6530 33	Height 3.9m Can be adapted to a ceiling Height up to 5.1m	46452	1

Aluminium finish

6530 31	Aluminium body and covers Height 2.70m Can be adapted to a ceiling Height up to 3.9m Height 3.9m	48278	1
6530 34	Can be adapted to a ceiling height up to 5.1m	62426	1

Finishing kit for telescopic pole for 1 or 2 compartments columns

6530 66	Consists of 2 PVC covers and a balse White finish	2494	1
6530 67	Aluminium finish	2668	1

Fixing clip

6038 57	Fixing clip-Signal white (set of 2 pcs.)	296	10
6038 58	Fixing clip - Grey/Anthracite (Set of 2 pcs.)	834	10

* MRP - Maximum Retail Price Inclusive of all taxes including GST.
(1) Price in Meters; No of meters in Pack, Standard length 2 meters to be ordered in multiples of 2 meters

www.legrand.co.in



Click to discover us

- 1** Legrand (India) - provides all information regarding the groups philosophy, products, organisation etc.
- 2** Products and solutions - complete information about our range of products for residential, commercial and industrial markets.
- 3** Downloads - download catalogues and brochures.

AUDIO/VIDEO PRETERMINATED SOCKETS

THE RIGHT SYSTEM TO MEET YOUR NEEDS

A wide range of technologies (HD15, HDMI, DISPLAY PORT, RCA, JACK) to suit the location and the user requirements

INSTALLATION EXAMPLE WITH HD15 PRETERMINATED SOCKET AND VIDEO PROJECTOR SWITCH

1 Quick
installation

2 Easy
connection

3 Optimum
performance

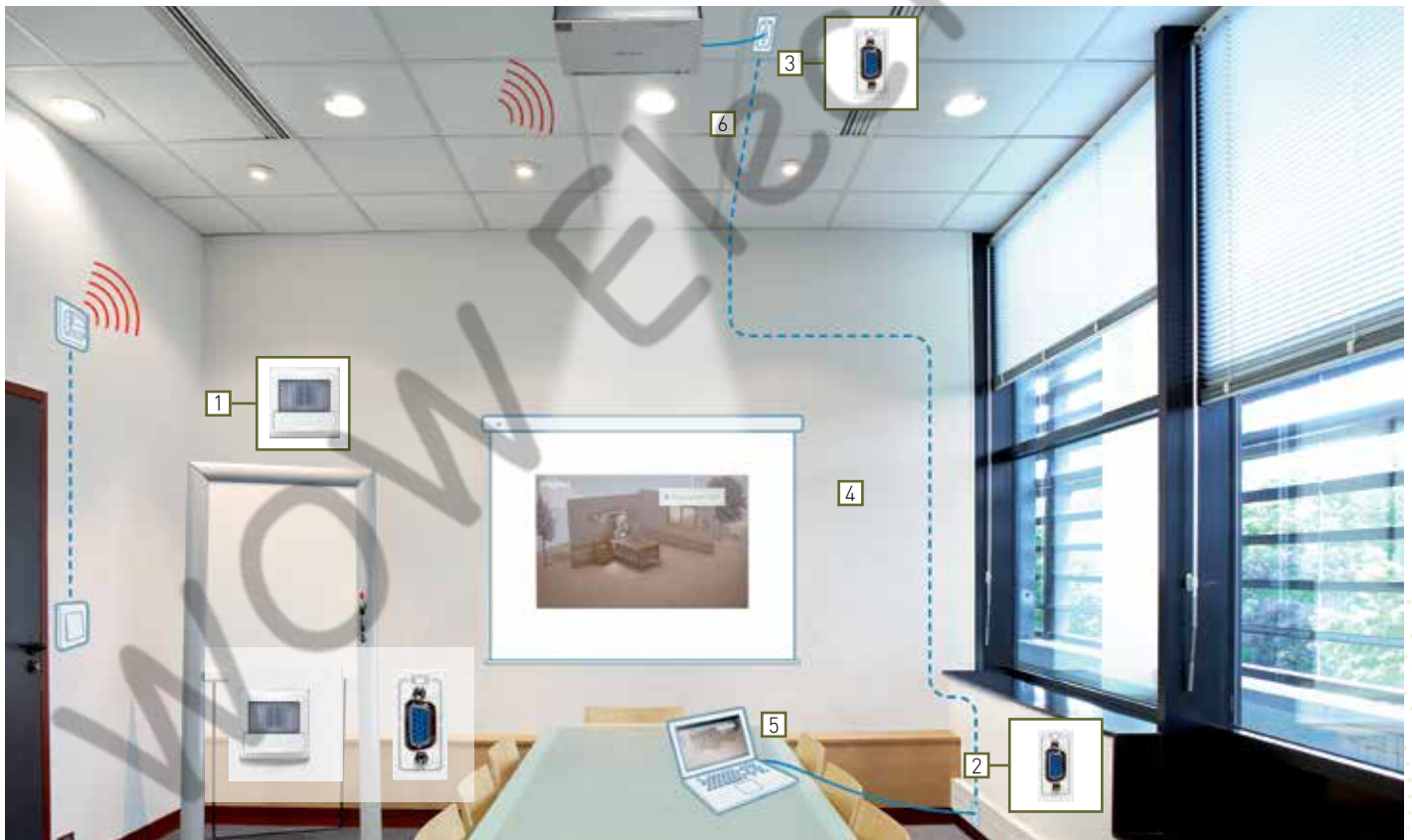

1 Infrared ON/STANDBY control for video projector associated with a pushbutton
Cat.No 0 787 99/5 720 89

2 3 Preterminated HD15 sockets Cat.No 0 787 77/5 720 97

4 10 m male/male HD15 cords Cat.No 0 517 23

5 6 Male/male HD 15 cords



Scan to know more about
the product.

Legrand cabling system LCS³ category 8

Cat.Nos	Description	MRP* ₹ / Unit	Pack
---------	-------------	------------------	------

Cat. 8 patch panel equipped with 24 RJ 45 connectors

Flat panel

0337 82	STP panel - Metal shielding	■	1
---------	-----------------------------	---	---



0337 82

Flat 24-connector patch panels - 1 U to be equipped

Flat panel with empty cassettes to be equipped with connectors

Equipped with 4 automatic extraction cassette for cat. 5e to cat. 8 RJ 45 connectors



0337 90

0337 90	19" patch panel - 1 U	■	1
---------	-----------------------	---	---

Empty flat panel to be equipped with cassette

It can accept a maximum of 4 automatic extraction cassettes:
- copper
- fibre optic

0337 91	19" patch panel - 1 U	■	1
---------	-----------------------	---	---

Angled 24-connector patch panel - 1 U

Angled panel to be equipped with connectors

It can accept up to 24 cat. 5e to cat. 8 RJ 45 connectors



0337 92

0337 92	19" panel - 1 U	■	
---------	-----------------	---	--

Cat. 8 RJ 45 connectors for flat and angled STP panel

0337 85	Set of 6 RJ 45 connectors For installation in the cassettes of flat or angled panels	■	1
---------	--	---	---

0337 85

Common accessories for flat and angled panels

Port blanking modules

0337 56	Divisible 6 port blanking plate for sealing from 1 to 6 ports	■	10
---------	--	---	----



0337 56

Cord management

0337 59	2 cord management for use with new generation Quick-Fix They provide side cord management	■	1
---------	--	---	---

0337 59

Specific accessories for flat panels

Cassette for flat panels to be equipped

0337 55	Empty removable cassette to be equipped with connectors. It can accept 6 cat. 5e to cat. 8 connectors. Extraction by simple pressure of the cassette making installation and maintenance easier	■	1
---------	--	---	---

0337 55

Blanking cassette

0337 57	Used to blank the panel	■	1
---------	-------------------------	---	---

0337 57

Specific accessories for angled panels

Angled panel cover

0337 58	For optimised management of the air flow inside the cabinet	■	1
---------	--	---	---

0337 58

* MRP - Maximum Retail Price Inclusive of all taxes including GST.

■ Price available on request.

(1) in meters

Legrand cabling system LCS³ category 8

Cat.Nos	Description	MRP* ₹ / Unit	Pack
---------	-------------	------------------	------

Cat. 8 local network cables

F/UTP - 4 pairs

Performance 2000 MHz

0337 86	Length 500 m supplied on drum. Weight 42 kg	■	500 ¹
---------	--	---	------------------

S/FTP - 4 pairs

Performance 2000 MHz

0337 88	Length 500 m supplied on drum. Weight 45 kg	■	500 ¹
---------	--	---	------------------

Cat. 8 RJ 45 patch cords

S/FTP shielded, impedance 100 Ω

LSZH - RAL 6027

0337 01	Length 0.5 m	■	
0337 02	Length 1 m	■	
0337 03	Length 2 m	■	
0337 04	Length 3 m	■	
0337 05	Length 5 m	■	
0337 06	Length 8 m	■	
0337 07	Length 10 m	■	

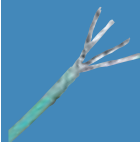

0337 88



0337 03

LSZH - RAL 3020

0337 21	Length 0.5 m	■	1
0337 22	Length 1 m	■	
0337 23	Length 2 m	■	
0337 24	Length 3 m	■	
0337 25	Length 5 m	■	
0337 26	Length 8 m	■	
0337 27	Length 10 m	■	1

LSZH - RAL 6026

0337 08	Length 0.5 m	■	1
0337 09	Length 1 m	■	
0337 10	Length 2 m	■	
0337 11	Length 3 m	■	
0337 12	Length 5 m	■	
0337 13	Length 8 m	■	
0337 17	Length 10 m	■	1

Marking kit

0518 90	Kit of 200 coloured rings for marking RJ 45 cords Rings to be clipped to the patch cords	■	1
---------	---	---	---



0518 90

Legrand cabling system LCS³ category 6_A

Cat. 6_A patch panels equipped with 24 RJ 45 connectors

Flat panels

24 RJ 45 connectors - 1 U

0337 70	UTP	■	1
0337 72	STP	■	1



0337 72

Bold Cat.Nos are products normally available with Legrand (India) Stockists. Cat.Nos that are not bold - delivery within 4 - 8 weeks from the date of order. Bold packing quantity is our mandatory packing. Orders to be placed by Legrand (India) Stockist in multiples of the same.

LCS³

FROM TECHNICAL ROOM TO WORKSTATION

Complete systems with a 20-year guarantee. The new LCS³ cat. 6a (up to 500 MHz), cat. 6 (up to 250 MHz) and cat. 5e (up to 100 MHz) systems have been designed as coherent entities to optimise their performance. The systems are suitable for optical fibre cables as well as copper cables.

The new LCS³ systems integrate perfectly in the various other Legrand solutions: DLP trunking system, cabling accessories, cable management, etc.



FIBRE OPTIC PANELS

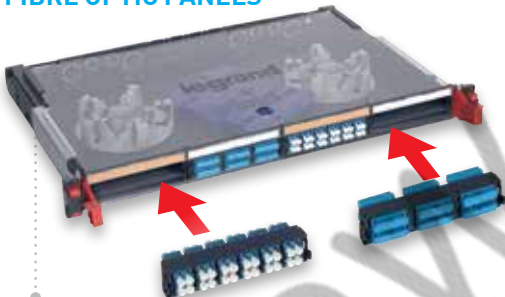

Modular panels

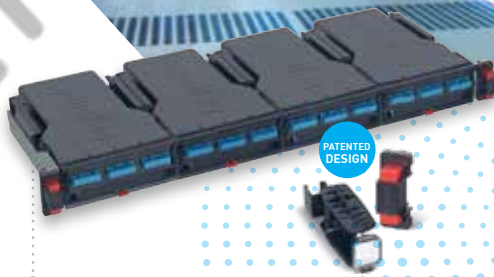

HD Modular panels

CORD LOCKING SYSTEM



AN INNOVATIVE TECHNICAL SOLUTION

FIBRE OPTIC SYSTEM

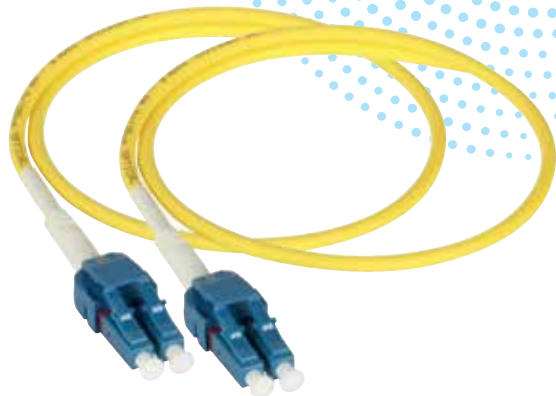

Scan to know more about the product.

NEW TOOLLESS CONNECTOR CONNECTION PHASES

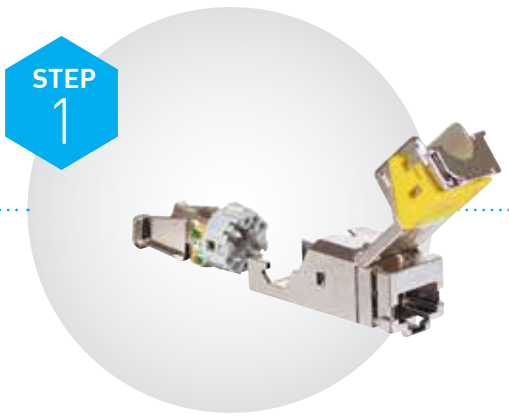

Take the wire housing

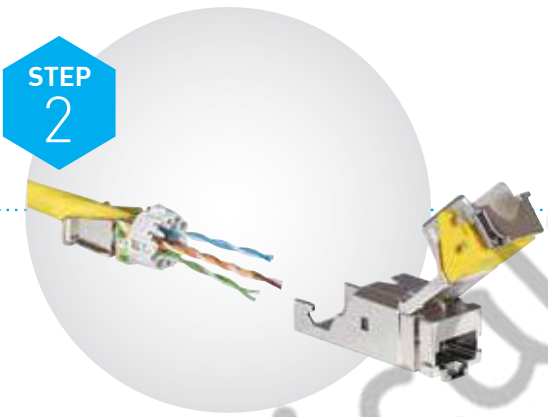

Pass the cable through the back of the wire housing

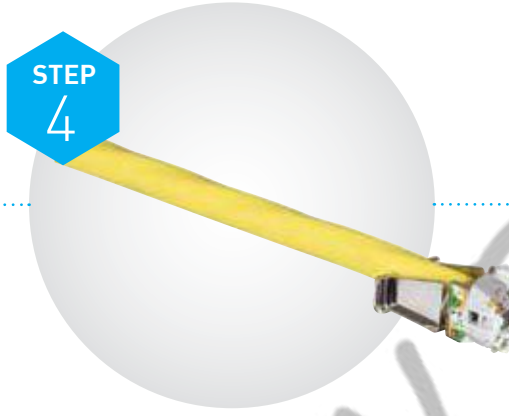

Cut the pairs

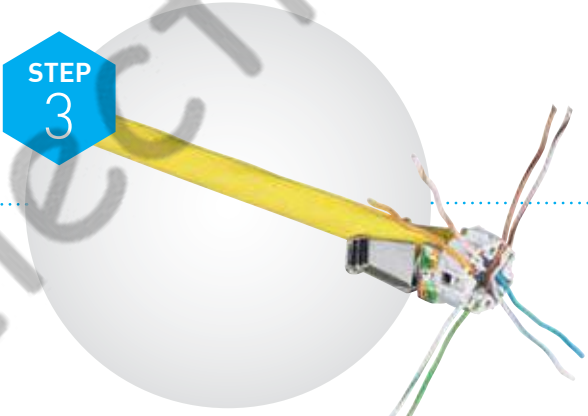

Separate and insert the pairs



Install the wire housing without pushing

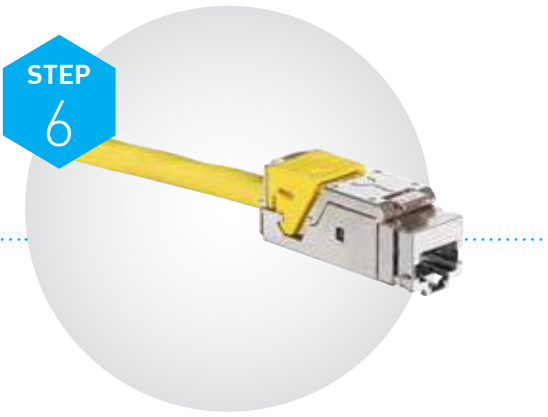

Push down the lever and lock the connector

Legrand cabling system LCS³ category 6_A

Cat.Nos	Description	MRP* ₹ / Unit	Pack
---------	-------------	------------------	------

Flat 24-connector patch panels - 1 U to be equipped

Flat panel with empty cassettes to be equipped with connectors

Equipped with 4 automatic extraction cassettes for cat. 5e to cat. 8 RJ 45 connectors

0337 90	19" panel - 1 U	■	1
---------	-----------------	---	---

Empty flat panel to be equipped with cassettes

It can accept a maximum of 4 automatic extraction cassettes:
- copper
- fibre optic

0337 91	19" panel - 1 U	■	1
---------	-----------------	---	---

Flat high density 48-connector patch panel - 1 U to be equipped

0 337 93	19" panel - 1 U	■	1
----------	-----------------	---	---

Angled 24-connector patch panel - 1 U

Angled panel to be equipped with connectors

It can accept up to 24 cat. 5e to cat. 8 RJ 45 connectors

0337 92	19" panel - 1 U	■	1
---------	-----------------	---	---

Angled high density 48-connector patch panel - 1 U to be equipped

Angled panel to be equipped with connectors

It can accept up to 48 cat. 5e to cat. 6A RJ 45 connectors

0337 94	19" panel - 1 U	■	1
---------	-----------------	---	---

High density cat. 6A RJ 45 connectors

0337 73	UTP	■	1
0337 75	STP	■	1

Common accessories for flat and angled panels

Port blanking modules

0337 56	Divisible 6 port blanking plate for sealing from 1 to 6 ports	■	10
---------	---	---	----

Cord management

0337 59	For use with new generation Quick-Fix; they provide side cord management	■	1
---------	--	---	---

Specific accessories for flat panels

Cassette for flat panels to be equipped

0337 55	Empty removable cassette to be equipped with connectors. It can accept 6 cat. 5e to cat. 8 connectors Extraction by simple pressure of the cassette making installation and maintenance easier Possibility of removing each connector individually	■	1
---------	--	---	---

* MRP - Maximum Retail Price Inclusive of all taxes including GST.
■ Price available on request.
(1) in meters

Legrand cabling system LCS³ category 6_A

Cat.Nos	Description	MRP* ₹ / Unit	Pack
---------	-------------	------------------	------

High density cassette for flat panels to be equipped

0337 95	Empty removable cassette to be equipped with connectors; it can accept 12 cat. 5e to cat. 6 _A connectors Extraction by simple pressure of the cassette, making installation and maintenance easier	■	1
---------	--	---	---

Blanking cassette

0337 57	Used to blank the panel	■	1
---------	-------------------------	---	---

Specific accessories for angled panels

Angled panel cover

0337 58	For optimised management of the air flow inside the cabinet	■	1
---------	---	---	---

Cables for local networks cat. 6A

LSZH - U/UTP - 4 pairs

Performance 500 MHz

0327 87	Length 500 m Supplied on reel. Weight 25 kg	■	500 ¹
---------	---	---	------------------

F/UTP - 4 pairs

Performance 500 MHz

0327 78	Length 500 m Supplied on reel. Weight 25 kg	■	500 ¹
---------	---	---	------------------

F/UTP - 2 x 4 pairs

Performance 500 MHz

0328 78	Length 500 m Supplied on reel. Weight 65 kg	■	500 ¹
---------	--	---	------------------

S/FTP - 4 pairs

Performance 600 MHz

0327 77	Length 500 m Supplied on reel. Weight 30 kg	■	500 ¹
---------	--	---	------------------

RJ 45 patch cords and user cords cat. 6A

PVC - U/UTP unshielded impedance 100 Ω

0518 82	Length 1 m	■	1
0518 83	Length 2 m	■	1
0518 84	Length 3 m	■	1
0518 85	Length 5 m	■	1

LSZH - U/UTP unshielded impedance 100 Ω

0518 78	Length 1 m	■	1
0518 79	Length 2 m	■	1
0518 80	Length 3 m	■	1
0518 81	Length 5 m	■	1
0518 74	Length 1 m	■	1
0518 75	Length 2 m	■	1
0518 76	Length 3 m	■	1
0518 77	Length 5 m	■	1

PVC - S/FTP shielded impedance 100 Ω

0518 16	Length 0.5 m	■	1
0517 80	Length 1 m	■	5
0517 81	Length 2 m	■	5
0517 82	Length 3 m	■	5
0517 83	Length 5 m	■	5

Bold Cat.Nos are products normally available with Legrand (India) Stockists. Cat.Nos that are not bold - delivery within 4 - 8 weeks from the date of order. Bold packing quantity is our mandatory packing. Orders to be placed by Legrand (India) Stockist in multiples of the same.

Legrand cabling system LCS³ category 6_A

Cat.Nos	Description	MRP* ₹ / Unit	Pack
---------	-------------	------------------	------

LSZH - S/FTP shielded impedance 100 Ω

0518 70	Length 1 m	■	1
0518 71	Length 2 m	■	1
0518 72	Length 3 m	■	1
0518 73	Length 5 m	■	1
0518 66	Length 1 m	■	1
0518 67	Length 2 m	■	1
0518 68	Length 3 m	■	1
0518 69	Length 5 m	■	1

Arteor RJ 45 socket cat. 6_A

360° metal shielding

STP - 1 module

5734 32	White	■	20
5728 06	Magnesium	■	10
5723 52	White with green shutter	■	10
5728 52	Magnesium with green shutter	■	10
5723 51	White with orange shutter	■	10
5728 51	Magnesium with orange shutter	■	10

STP with controlled access - 2 modules

Supplied with 2 keys for 5 sockets

5723 50	White with red shutter	■	5
5728 50	Magnesium with red shutter	■	5

UTP - 1 module

5723 49	White	■	10
5728 49	Magnesium	■	10
5723 59	White with green shutter	■	10
5728 59	Magnesium with green shutter	■	10
5723 58	White with orange shutter	■	10
5728 58	Magnesium with orange shutter	■	10

UTP with controlled access - 2 modules

Supplied with 2 keys for 5 sockets

5723 57	White with red shutter	■	5
5728 57	Magnesium with red shutter	■	5

Legrand cabling system LCS³ category 6

Cat. 6 patch panels equipped with 24 RJ 45 connectors

Flat panels

24 RJ 45 connectors - 1 U

0337 60	UTP	■	1
0337 61	FTP	■	1
0337 62	STP	■	1

Flat 24-connector patch panels - 1 U to be equipped

Flat panel with empty cassettes to be equipped with connectors

Equipped with 4 automatic extraction cassettes for cat. 5e to cat. 8 RJ 45 connectors

0337 90	19" panel - 1 U	■	1
---------	-----------------	---	---

* MRP - Maximum Retail Price Inclusive of all taxes including GST.

■ Price available on request.

(1) in meters

Legrand cabling system LCS³ category 6

Cat.Nos	Description	MRP* ₹ / Unit	Pack
---------	-------------	------------------	------

Empty flat panel to be equipped with cassettes

It can accept a maximum of 4 automatic extraction cassettes:
- copper
- fibre optic

0337 91	19" patch panel - 1 U	■	1
---------	-----------------------	---	---

Flat high density 48-connector patch panel - 1 U to be equipped

0337 93	19" panel - 1 U	■	1
---------	-----------------	---	---

Angled 24-connector patch panels - 1 U

Angled panel to be equipped with connectors

It can accept up to 24 cat. 5e to cat. 8 RJ 45 connectors

0337 92	19" panel - 1 U	■	1
---------	-----------------	---	---

Angled high density 48-connector patch panel - 1 U to be equipped

Angled panel to be equipped with connectors

It can accept up to 48 cat. 5e to cat. 6_A RJ 45 connectors

0337 94	19" panel - 1 U	■	1
---------	-----------------	---	---

Cat. 6 high density RJ 45 connectors

0337 63	UTP	■	1
0337 64	FTP	■	1
0337 65	STP	■	1

Common accessories for flat and angled panels

Port blanking modules

0337 56	Divisible 6 port blanking plate for sealing from 1 to 6 ports	■	10
---------	---	---	----

Cord management

0337 59	For use with new generation Quick-Fix; they provide side cord management	■	1
---------	--	---	---

Specific accessories for flat panels

0337 55	Cassette for flat panels to be equipped	■	1
0337 95	High density cassette for flat panels to be equipped	■	1
0337 57	Blanking cassette Used to blank the panel	■	1

Specific accessories for angled panels

Angled panel cover

0337 58	For optimised management of the air flow inside the cabinet	■	1
---------	---	---	---

Bold Cat.Nos are products normally available with Legrand (India) Stockists. Cat.Nos that are not bold - delivery within 4 - 8 weeks from the date of order. Bold packing quantity is our mandatory packing. Orders to be placed by Legrand (India) Stockist in multiples of the same.



5734 32



5723 57



0337 93



0337 92



0337 94



0337 63



0337 56



0337 59



0337 55



0337 95



0337 58



0337 61



0337 90

Legrand cabling system LCS³ category 6

Cat.Nos	Description	MRP* ₹ / Unit	Pack
---------	-------------	------------------	------

Cables for cat. 6 LANs

Cables with 4 pairs or 2 x 4 twisted pairs
100 ohms. Colour code TIA/EIA
Conform to standards ISO/IEC 11801
Ed. 2.0, EN 50173-1 and TIA/EIA 568 C

LSZH - U/UTP - 4 pairs

0327 54I	Length 305 m. Supplied in cardboard box Weight 16 kg., Violet RAL 4005	■	305 ¹
0328 61	Length 500 m. Supplied on reel. Weight 18 kg. Blue RAL 5015	■	500 ¹

PVC - U/UTP - 4 pairs

0327 55W	Length 305 m Supplied in cardboard box, Weight 13 kg., White RAL 9003, MOQ 50 Box	■	305 ¹
0327 55	Length 305 m Supplied in cardboard box Weight 13 kg. Blue RAL 5015	■	305 ¹
0327 55O	Length 305 m Supplied in cardboard box, Weight 13 kg., Orange RAL 2008, MOQ 50 Box	■	305 ¹
0327 55G	Length 305 m Supplied in cardboard box, Weight 13 kg., Green RAL 6018/6024, MOQ 50 Box	■	305 ¹

LSZH - U/UTP - 4 pairs

0327 54I	Length 305 m Supplied in cardboard box. Weight 16 kg	■	305 ¹
0328 61	Length 500 m Supplied on reel. Weight 18 kg	■	500 ¹

PVC - U/UTP - 4 pairs

0327 55	Length 305m Supplied in cardboard box. Weight 13 kg	■	305 ¹
---------	---	---	------------------

LSZH - F/UTP - 4 pairs

0328 56	Length 305 m. Supplied on reel. Weight 17 kg	■	305 ¹
0327 56	Length 500 m. Supplied on reel. Weight 25 kg	■	500 ¹

PVC - F/UTP - 4 pairs

0328 57	Length 305 m Supplied in cardboard box. Weight 17 kg	■	305 ¹
0327 58	Length 500 m Supplied on reel. Weight 25 kg	■	500 ¹

LSZH - F/UTP - 2 x 4 pairs

0327 76	Length 500 m. Supplied on reel. Weight 48 kg	■	500 ¹
---------	---	---	------------------

LSZH - SF/UTP - 4 pairs

0327 57	Length 500 m. Supplied on reel. Weight 29 kg	■	500 ¹
---------	---	---	------------------

PVC - SF/UTP - 4 pairs

0327 59	Length 500 m. Supplied on reel. Weight 30 kg	■	500 ¹
---------	---	---	------------------

* MRP - Maximum Retail Price Inclusive of all taxes including GST.

■ Price available on request.

(1) in meters

Legrand cabling system LCS³ category 6

Cat.Nos	Description	MRP* ₹ / Unit	Pack
---------	-------------	------------------	------

LSZH - F/FTP - 2 x 4 pairs

0327 98	Length 500 m. Weight 62 kg	■	
---------	----------------------------	---	--

PVC - F/FTP - 4 pairs

0327 99	Length 500 m. Weight 25,2 kg	■	
---------	------------------------------	---	--

RJ 45 patch cords and user cords cat. 6

RJ 45 - RJ 45 right

PVC - U/UTP unscreened impedance 100 Ω

0518 18	Length 0.5 m	■	1
0517 72	Length 1 m	■	1
0517 73	Length 2 m	■	1
0517 74	Length 3 m	■	1
0517 75	Length 5 m	■	1

LSZH - U/UTP unscreened impedance 100 Ω

0518 62	Length 1 m	■	1
0518 63	Length 2 m	■	1
0518 64	Length 3 m	■	1
0518 65	Length 5 m	■	1
0518 58	Length 1 m	■	1
0518 59	Length 2 m	■	1
0518 60	Length 3 m	■	1
0518 61	Length 5 m	■	1

PVC - F/UTP screened impedance 100 Ω

0518 15	Length 0.5 m	■	1
0517 62	Length 1 m	■	1
0517 63	Length 2 m	■	1
0517 64	Length 3 m	■	1
0517 65	Length 5 m	■	1

LSZH - F/UTP screened impedance 100 Ω

0518 54	Length 1 m	■	1
0518 55	Length 2 m	■	1
0518 56	Length 3 m	■	1
0518 57	Length 5 m	■	1
0518 50	Length 1 m	■	1
0518 51	Length 2 m	■	1
0518 52	Length 3 m	■	1
0518 53	Length 5 m	■	1

PVC - SF/UTP shielded impedance 100 Ω

0517 52	Length 1 m	■	5
0517 53	Length 2 m	■	5
0517 54	Length 3 m	■	5
0517 55	Length 5 m	■	5

Bold Cat.Nos are products normally available with Legrand (India) Stockists.
Cat.Nos that are not bold - delivery within 4 - 8 weeks from the date of order.
Bold packing quantity is our mandatory packing. Orders to be placed by
Legrand (India) Stockist in multiples of the same.

Legrand cabling system LCS³ category 6

Cat.Nos	Description	MRP* ₹ / Unit	Pack
---------	-------------	------------------	------

RJ 45 sockets

Sockets with LCS³ quick-fixing crimp connector. Take AWG 22 single-core cables up to AWG 26 and AWG 24 multicore cables. Contacts marked with dual colour code and wiring schemes T 568 A and T 568 B. Conforming to standards ISO/IEC 11801 Ed. 2.0, EN 50173-1 and TIA/EIA 568

Arteor RJ 45 socket cat. 6

UTP - 1 module

5734 28	White	■	20
5736 28	Magnesium	■	20
5723 54	White with orange shutter	■	10
5728 54	Magnesium with orange shutter	■	10
5723 55	White with green shutter	■	10
5728 55	Magnesium with green shutter	■	10

UTP - 2 modules

5734 74	White	■	10
5736 74	Magnesium	■	10

UTP - 2 modules - round

5723 24	White	■	10
5728 24	Magnesium	■	10

UTP with controlled access - 2 modules

Supplied with 2 keys for 5 sockets

5723 53	White with red shutter	■	5
5728 53	Magnesium with red shutter	■	5

UTP retractable RJ 45 sockets - 4 modules

With integrated retractable cord (0.9 m)
Winds up automatically with a pushbutton

5723 39	White	■	1
5728 39	Magnesium	■	1

FTP - 1 module

5723 22	White	■	10
5728 22	Magnesium	■	10

FTP - 2 modules

5734 76	White	■	10
5736 76	Magnesium	■	10

Shielded STP - 1 module

5734 34	White	■	10
5736 34	Magnesium	■	10

Shielded STP - 2 modules

5734 77	White	■	10
5736 77	Magnesium	■	10

Mylic RJ 45 socket cat. 6

UTP - 1 module

6755 45	White	■	20
---------	-------	---	----

* MRP - Maximum Retail Price Inclusive of all taxes including GST.

■ Price available on request.

(1) in meters

Legrand cabling system LCS³ category 6

Cat.Nos	Description	MRP* ₹ / Unit	Pack
---------	-------------	------------------	------

Myrius RJ 45 sockets cat. 6

UTP - 1 module

6730 55	White	■	20
6731 55	Black	■	20

UTP - 2 modules

6730 56	White	■	20
6731 56	Black	■	20

Soliroc RJ 45 sockets cat. 6 - IK 10

0778 91	IP 20 For at-risk areas or areas with no surveillance FTP socket	■	10
---------	--	---	----

Plexo RJ 45 sockets cat. 6 - IP 55 closed flap IK 07

Protection against water, dust. For industrial sites

0695 69	FTP socket Grey/white	■	5/100
0695 61	UTP socket Grey/white	■	1/20
0695 81	Adaptor for RJ 45 socket Weatherproofing ensured (IP 44) plug inserted Grey/white	■	1

Plexo 66 RJ 45 socket cat. 6 - IP 66 - IK 08

FTP socket

0904 67	9 contacts Weatherproofing ensured (IP 66) with plug inserted Inclined 90° Grey RAL 7016/T029	■	1
---------	---	---	---

Patch panels cat. 6

6327 91	24 x RJ 45 connectors, for unshielded keystone	■	1
---------	--	---	---

Keystone RJ 45 sockets cat. 6

0765 88	Cat 6 UTP socket with fast connection thanks to integrated crimping	■	10
---------	---	---	----

Surface mounting box

1 or 2 ports

6327 79	For keystone connectors Provides solution for integration of keystone in surface mounting installations	■	20
---------	---	---	----

Cables for cat 6 LANs 24 AWG

U/UTP - 4 Pairs

6327 24	Length 305 m Supplied in cardboard box Weight 16 kg. Dark grey RAL 7037	■	305
6327 24W	Length 305 m Supplied in cardboard box Weight 16 kg. White RAL 9003. MOQ - 50 box	■	305
6327 24O	Length 305 m Supplied in cardboard box Weight 16 kg. Orange RAL 2008 MOQ 50 Box	■	305
6327 24G	Length 305 m Supplied in cardboard box Weight 16 kg. Green RAL 6018 / 6024 MOQ 50 Box	■	305

Bold Cat.Nos are products normally available with Legrand (India) Stockists. Cat.Nos that are not bold - delivery within 4 - 8 weeks from the date of order. Bold packing quantity is our mandatory packing. Orders to be placed by Legrand (India) Stockist in multiples of the same.



5736 28



5728 24



6755 45



6730 56



0778 91



0695 69



0904 67



6327 91



0765 88

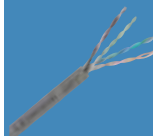

6327 24

Legrand cabling system LCS³ category 6

Cat.Nos	Description	MRP* ₹ / Unit	Pack
---------	-------------	------------------	------

Patch cords

RJ 45 - RJ 45
PVC

0337 51

U/UTP cat. 6 unscreened impedance 100 Ω

Light blue

6327 50	Length 1 m	■	20
6327 51	Length 1.5 m	■	20
6327 52	Length 2 m	■	20
6327 53	Length 3 m	■	20
6327 54	Length 5 m	■	20

F/UTP cat. 6 screened impedance 100 Ω

Blue-green

6327 60	Length 1 m	■	20
6327 61	Length 2 m	■	20
6327 62	Length 3 m	■	20
6327 63	Length 5 m	■	20

Legrand cabling system LCS³ category 5e

**Cat. 5e patch panels equipped with
24 RJ 45 connectors**

**Flat panel with empty cassettes to be equipped with
connectors**

24 RJ 45 connectors - 1 U

0337 50	UTP	■	1
0337 51	FTP	■	1

**Flat 24-connector patch panels -
1 U to be equipped**

**Flat panel with empty cassettes to be equipped with
connectors**

Equipped with 4 automatic extraction cassettes for cat. 5e to
cat. 8 RJ 45 connectors

0337 90	19" panel - 1 U	■	1
---------	-----------------	---	---

Empty flat panel to be equipped with cassettes

It can accept a maximum of 4 automatic extraction cassettes:
- copper
- fibre optic

0337 91	19" panel - 1 U	■	1
---------	-----------------	---	---

**Flat high density 48-connector patch panel -
1 U to be equipped**

0337 93	19" panel - 1 U	■	1
---------	-----------------	---	---

Angled 24-connector patch panel - 1 U

Angled panel to be equipped with connectors

It can accept up to 24 cat. 5e to cat. 8 RJ 45 connectors

0337 92	19" panel - 1 U	■	1
---------	-----------------	---	---

**Angled high density 48-connector
patch panel - 1 U to be equipped**

0337 94	19" panel - 1 U	■	1
---------	-----------------	---	---

* MRP - Maximum Retail Price Inclusive of all taxes including GST.

■ Price available on request.

(1) in meters

Legrand cabling system LCS³ category 5e

Cat.Nos	Description	MRP* ₹ / Unit	Pack
---------	-------------	------------------	------

Cat. 5e High density RJ 45 connectors

0337 53	UTP	■	1
0337 54	FTP	■	1

Common accessories for flat and angled panels

Port blanking modules

0337 56	Divisible 6 port blanking plate for sealing from 1 to 6 ports	■	10
---------	--	---	----

Cord management

0337 59	For use with new generation Quick-Fix They provide side cord management	■	1
---------	--	---	---

Specific accessories for flat panels

0337 55	Cassette for flat panels to be equipped	■	1
0337 95	High density cassette for flat panels to be equipped	■	1
0337 57	Blanking cassette Used to blank the panel	■	1

Specific accessories for angled panels

Angled panel cover

0337 58	For optimised management of the air flow inside the cabinet	■	1
---------	--	---	---

Cables for local networks cat. 5e

LSZH - U/UTP - 4 pairs

0327 50	Length 305 m Supplied in cardboard box. Weight 16 kg	■	305 ¹
0328 53	Length 500 m Supplied on reel. Weight 15 kg	■	500 ¹

PVC - U/UTP - 4 pairs

0327 51	Length 305 m Supplied in cardboard box. Weight 9 kg	■	305 ¹
---------	---	---	------------------

LSZH - F/UTP - 4 pairs

0327 52	Length 305 m Supplied in cardboard box. Weight 12 kg	■	305 ¹
0328 50	Length 500 m Supplied on reel. Weight 21 kg	■	500 ¹

PVC - F/UTP - 4 pairs

0327 53	Length 305 m Supplied by box. Weight 11 kg	■	305 ¹
---------	---	---	------------------

RJ 45 patch cords and user cords cat. 5e

RJ 45 - RJ 45 right

PVC - U/UTP unscreened impedance 100 Ω

Grey

0518 17	Length 0.5 m	■	1
0516 36	Length 1 m	■	1
0516 37	Length 2 m	■	1
0516 38	Length 3 m	■	1
0516 39	Length 5 m	■	1

Bold Cat.Nos are products normally available with Legrand (India) Stockists.
Cat.Nos that are not bold - delivery within 4 - 8 weeks from the date of order.
Bold packing quantity is our mandatory packing. Orders to be placed by
Legrand (India) Stockist in multiples of the same.

Legrand cabling system LCS³ category 5e

Cat.Nos	Description	MRP* ₹ / Unit	Pack
---------	-------------	------------------	------

F/UTP screened impedance 100 Ω

Grey

0518 14	Length 0.5 m	■	1
0516 40	Length 1 m	■	1
0516 41	Length 2 m	■	1
0516 42	Length 3 m	■	1
0516 43	Length 5 m	■	1

Myrius RJ 45 sockets cat. 5e

UTP - 1 module

6730 54	White	■	20
6731 54	Black	■	20

Mylic RJ 45 sockets cat. 5e

UTP - 1 module

6755 47	White	■	20
---------	-------	---	----

Arteor RJ 45 socket cat. 5e

UTP - 1 module

5734 29	White	■	20
5736 29	Magnesium	■	20

UTP - 2 modules

5734 75	White	■	10
5736 75	Magnesium	■	20

FTP - 1 module

5734 30	White	■	20
5736 30	Magnesium	■	20

Plexo RJ 45 sockets, cat. 5e - IP 55 closed flap IK 07

Protection against water, dust
For industrial sites

0695 57	FTP socket Grey/White	■	1/20
0695 56	UTP socket Grey/White	■	1/20
0695 81	Adaptor for RJ 45 socket Ensures weatherproofing (IP 44) with the plug inserted Grey/White	■	1

Patch panels cat. 5e

6327 91	24 x RJ 45 connectors, for unshielded keystone	■	1
---------	--	---	---

Keystone RJ 45 sockets cat. 5e

0765 87	Cat 5e UTP socket with fast connection thanks to integrated crimping	■	10
---------	--	---	----

Surface mounting box

1 or 2 ports

6327 79	For keystone connectors Provides solution for integration of keystone in surface mounting installations	■	20
---------	--	---	----

* MRP - Maximum Retail Price Inclusive of all taxes including GST.

■ Price available on request.

(1) in meters

Legrand cabling system LCS³ category 5e

Cat.Nos	Description	MRP* ₹ / Unit	Pack
---------	-------------	------------------	------

Patch cords

RJ 45 - RJ 45 - PVC

U/UTP cat. 5e unscreened impedance 100 Ω

Light pink

6327 30	Length 1 m	■	20
6327 31	Length 1.5 m	■	20
6327 32	Length 2 m	■	20
6327 33	Length 3 m	■	20
6327 34	Length 5 m	■	20

F/UTP cat. 5e screened impedance 100 Ω

Light brown

6327 40	Length 1 m	■	20
6327 41	Length 2 m	■	20
6327 42	Length 3 m	■	20
6327 43	Length 5 m	■	20

Legrand cabling system LCS³ doubler sockets, adaptors and accessories

RJ 45 doubler sockets

Arteor - Telephone/Ethernet

5723 36	FTP - 9 contacts - White	■	10
5728 36	FTP - 9 contacts - Magnesium	■	10
5723 35	UTP - 8 contacts - White	■	10
5728 35	UTP - 8 contacts - Magnesium	■	10

Mobile doublers

Clip into RJ 45 sockets to double applications

0327 83	TV/computer network or telephone double connector	■	10
0327 47	Telephone/telephone doubler	■	10
0327 45	Computer network/telephone doubler	■	10
0327 46	L1/L2 telephone doubler	■	10
0327 48	Computer network/computer network double connector	■	10

Weatherproof adaptors

IP 55 - IK 07 - Allow all functions to be adapted
2 Mosaic modules IP 55 operation

Grey/White

0695 80	Adaptor with smoked flap	■	10
0695 79	Adaptor with smoked flap lockable by special tool	■	1
0695 81	Adaptor for RJ socket ensuring IP 44 waterproofness cable already connected	■	1
0919 45	Locking tool (used for changing vandal-proof screws)	■	1

Bold Cat.Nos are products normally available with Legrand (India) Stockists. Cat.Nos that are not bold - delivery within 4 - 8 weeks from the date of order. Bold packing quantity is our mandatory packing. Orders to be placed by Legrand (India) Stockist in multiples of the same.

Legrand cabling system LCS³ doubler sockets, adaptors and accessories

Cat.Nos	Description	MRP* ₹ / Unit	Pack
---------	-------------	------------------	------

Soliroc adaptor

Used for adapting all functions 2 Mosaic modules

IK 10 - IP 55

0778 80	Adaptor with flap	■	1
0778 81	Adaptor without flap	■	1

Hypra adaptor

0539 49	IP 55 adaptor base	■	5
---------	--------------------	---	---

Cable protection accessories

Plastic material

IP 66/67 guaranteed connection with the pair
Cat.No 0 533 02

IP 55 with no connection for base with blank

Protection for RJ 45 shielded or unshielded cables ensuring a link of category 5

Conform to standards of the IEC 60603-7 series and to standard IEC 61076-3-106 (version 5)

Compatible with products on the market conforming to the standards listed

Plug

0533 00	Integrated PE with sealing ring and clamping blades Tool-free assembly Ability to protect cables of category 5e	■	3
---------	---	---	---

Flush-mounting base

0533 01	Locking base Supplied with RJ 45 female/female coupler cat. 5e	■	3
---------	--	---	---

Kit

0533 02	Flush-mounting base + plug	■	3
---------	----------------------------	---	---

Protective flap

0533 03	Fits on base Cat.No 0 533 01	■	3
---------	------------------------------	---	---

RJ plugs for round cables

Gold-coated contacts 1.2 µm

RJ 11

0517 01	4 contacts, width 9.65 mm	■	50
---------	---------------------------	---	----

RJ 12

0517 02	6 contacts, width 9.65 mm	■	50
---------	---------------------------	---	----

RJ 45 cat. 5e

0517 03	8 contacts, width 11.70 mm	■	50
0517 04	9 contacts, width 11.70 mm	■	50

RJ 45 sleeves

0517 06	Black	■	50
0517 07	White	■	50

Stripping tool

Slits the sheath and releases the conductors by rotation

For twisted pair cables

Does not damage the conductors

Stripper

0332 62	For twisted pair and fibre optic cable	■	1
---------	--	---	---

* MRP - Maximum Retail Price Inclusive of all taxes including GST.

■ Price available on request.

(1) in meters

Legrand cabling system LCS³ doubler sockets, adaptors and accessories

Cat.Nos	Description	MRP* ₹ / Unit	Pack
---------	-------------	------------------	------

Cutting pliers

0327 60	Cut wires cleanly without damaging the copper	■	1
---------	---	---	---

Crimping tool for RJ 45 plugs

Used for crimping plugs

RJ 4/6/8/9 contacts

Ratchet control of crimping

mechanism Able to cut and strip cables

0517 09	Tool with 3 crimping points High resistance steel material	■	1
---------	--	---	---

110 tool

0332 60	110 tool	■	1
0332 61	Replacement blade	■	1

Legrand cabling system LCS³ data and telephone sockets, patch panels, cables

Telephone sockets

RJ 11 and RJ 12 sockets

Equipped with a modular Jack connector with 1/4 turn terminal for fast connection Tap-off possible

5723 00	White - RJ 11, 4 contacts 1 module	■	10
-	Aluminium - RJ 11, 4 contacts - 1 module	■	10
5728 00	Magnesium - RJ 11, 4 contacts - 1 module	■	10
5723 13	White - RJ 11, 4 contacts - 2 modules	■	10
5728 13	Magnesium - RJ 11, 4 contacts - 2 modules	■	10
5723 12	White - RJ 12, 6 contacts - 2 modules	■	10
5728 12	Magnesium - RJ 12, 6 contacts - 2 modules	■	10

ISDN socket

Self-stripping 1/4 turn terminals for fast connection. Tap-off possible

-	White - 8 contacts, 2.5 mm 2 earth terminal	■	10
---	---	---	----

Single master - 2 modules

With IDC connection

Conform to British Telecom

5723 10	White	■	10
5728 10	Magnesium	■	10

Single secondary - 1 module

With IDC connection

Conform to British Telecom

5723 01	White	■	5
5728 01	Magnesium	■	5

Bold Cat.Nos are products normally available with Legrand (India) Stockists. Cat.Nos that are not bold - delivery within 4 - 8 weeks from the date of order. Bold packing quantity is our mandatory packing. Orders to be placed by Legrand (India) Stockist in multiples of the same.

Legrand cabling system LCS³ data and telephone sockets, patch panels, cables

Cat.Nos	Description	MRP* ₹ / Unit	Pack
---------	-------------	------------------	------

Patch panel telephone 50 ports 110 connect

0335 79	19" panel - 1 U	■	1
---------	-----------------	---	---

Cables for telephone networks cat. 3

PVC sleeve
Colour white
Colour code TIA/EIA

U/UTP - 50 pairs

0328 91	Length 500 m Supplied on reel	■	1
---------	----------------------------------	---	---

U/UTP - 100 pairs

0328 88	Length 500 m Supplied on reel	■	1
---------	----------------------------------	---	---

Panels and units for incoming telephone

Panels assembled - 1 U

Fitted with 4 LCS³ RJ 45 units of 12 ports with fast tool-free connection

0335 31	3-6/4-5 contacts for digital telephone	■	1
0335 30	4-5/7-8 contacts for analogue telephone	■	1

Incoming telephone units for self-assembly panels

Fitted with 12 LCS³ RJ 45 ports with quick tool-free connection

0335 33	3-6/4-5 contacts for digital telephone	■	2
0335 32	4-5/7-8 contacts for analogue telephone	■	2

Audio/video system audio/video sockets

Female HD15 sockets

Used to transmit analogue video streams (VGA, XGA, UXGA depending on graphic card) between a source (computer) and a compatible receiver (video projector, TV, etc)

Arteor - Preterminated sockets - 1 module

Equipped with cord, length 15 cm

5720 97	White	■	1
5725 97	Magnesium	■	1

Arteor - Screw-type female HD15 sockets - 2 modules

5722 82	White	■	1
5727 82	Magnesium	■	1

Arteor - Screw-type female HD15 sockets 2 modules + 3.5 mm Jack

5722 88	White	■	1
5727 88	Magnesium	■	1

Arteor - Solder-type female HD15 sockets 1 module

15 pin

5722 79	White	■	1
5727 79	Magnesium	■	1

* MRP - Maximum Retail Price Inclusive of all taxes including GST.
■ Price available on request.

Audio/video system audio/video sockets

Cat.Nos	Description	MRP* ₹ / Unit	Pack
---------	-------------	------------------	------

HDMI type A sockets

Used to transmit high-definition digital audio/video streams between a source (computer, HD-DVD drive, etc) and a compatible receiver (TV, video projector, etc)

Arteor - Preterminated sockets HDMI 1.4 - 1 module

Equipped with cord, length 15 cm

5720 96	White	■	1
5725 96	Magnesium	■	1

Arteor - Screw-type sockets HDMI 1.3 - 2 modules

5722 81	White	■	1
5727 81	Magnesium	■	1

Jack sockets 3.5 mm

3.5 mm Jack connectors can be used to create audio/video links

Arteor - Preterminated sockets - 1 module

Equipped with cord, length 15 cm

5720 91	White	■	1
5725 91	Magnesium	■	1

Arteor - 4 screw-type female 3.5 mm Jack socket - 1 module

5722 74	White	■	1
5727 74	Magnesium	■	1

Arteor - Solder-type female 3.5 mm Jack socket - 1 module

5722 78	White	■	1
---------	-------	---	---

Display port sockets

Used to transmit high-definition digital audio/video streams between a source (laptop, computer, etc) and a compatible receiver (video projector, TV, etc)

Arteor - Preterminated socket - 1 module

Equipped with cord, length 15 cm

5720 90	White	■	1
5725 90	Magnesium	■	1

Arteor - Female 2 RCA socket

Preterminated

Equipped with a 15 cm cord

5720 92	White	■	1
5725 92	Magnesium	■	1

Connection via screw terminals

5722 72	White	■	1
5727 72	Magnesium	■	1

Arteor - Female 3 RCA socket

Preterminated

Equipped with a 15 cm cord

5720 93	White	■	1
5725 93	Magnesium	■	1

Bold Cat.Nos are products normally available with Legrand (India) Stockists. Cat.Nos that are not bold - delivery within 4 - 8 weeks from the date of order. Bold packing quantity is our mandatory packing. Orders to be placed by Legrand (India) Stockist in multiples of the same.

0335 79

5720 96

5720 97

5722 72

Audio/video system audio/video sockets

Cat.Nos	Description	MRP* ₹ / Unit	Pack
---------	-------------	------------------	------

Connection via screw terminals

5722 73	White	■	1
5727 73	Magnesium	■	1

5727 73

Other audio and video sockets

Female BNC 75 socket - 1 module

5722 76	White	■	1
5727 76	Magnesium	■	1

5722 76

Arteor - Audio sockets

XLR 3-pin - 2 modules

5722 83	White - Fast screw connection female	■	1
5727 83	Magnesium - Fast screw connection female	■	1
5722 77	White - Fast screw connection male	■	1

5722 83

Loudspeakers sockets

Terminal 4 mm²

5722 80	White - 2 modules	■	10
5727 80	Magnesium - 2 modules	■	10
5722 70	White - 1 module	■	10
5727 70	Magnesium - 1 module	■	10

5727 70

100 V Line Volume Attenuators - 2 modules

Used to adjust power and volume of a 100 V loudspeaker line

5722 84	White - 100 V - 25 W	■	1
5727 84	Magnesium - 100 V - 25 W	■	1

5722 84

Audio/video system audio/video patch panels, cords and cables

19" patch panels

0335 98	HD15 19" panel - 12 connectors	■	1
0335 97	HDMI 19" panel - 16 connectors	■	1
0335 96	XLR 19" panel - 16 connectors	■	1
0335 99	SUBD9 19" panel - 12 connectors	■	1

0335 98

0335 96

0335 97

0335 99

Cords

For connecting a socket to a terminal

HD15 cord

0517 23	Length 10 m.	■	1
---------	--------------	---	---

0517 23

HD15 cord + 3.5 mm Jack

0517 22	Length 2 m	■	1
---------	------------	---	---

HDMI 1.4 cord

0517 26*	Length 1.5 m	■	1
0517 27*	Length 5 m	■	1
0517 20*	Length 10 m	■	1

* MRP - Maximum Retail Price Inclusive of all taxes including GST.

■ Price available on request.

* To be introduced shortly.

Audio/video system audio/video patch panels, cords and cables

Cat.Nos	Description	MRP* ₹ / Unit	Pack
---------	-------------	------------------	------

HDMI booster

0779 30	Used to extend an HDMI connection.	■	1
---------	------------------------------------	---	---

XLR cord

0517 24	Length 10 m.	■	1
---------	--------------	---	---

0517 24

9-way SUB-D cord

0517 25	Length 10 m.	■	1
---------	--------------	---	---

Cables

VGA cables

0327 81	Length 20 m	■	1
---------	-------------	---	---

HDMI cables

0327 80	Length 20 m	■	1
---------	-------------	---	---

Legrand cabling system LCS³ fibre optic

Equipped 19" optic drawers

Sliding

0321 61	12 SC duplex multi-mode connectors for 24 fibres	■	1
0321 62	24 LC duplex multi-mode connectors for 48 fibres	■	1
0321 63	24 ST multi-mode connectors for 48 fibres	■	1
0321 64	12 SC duplex single-mode connectors for 24 fibres	■	1
0321 65	24 LC duplex single-mode connectors for 48 fibres	■	1
0321 66	12 SC APC duplex single-mode connectors for 24 fibres	■	1
0321 67	24 LC APC duplex single-mode connectors for 48 fibres	■	1

0321 62

Rotating

0321 71	36 LC duplex multi-mode connectors for 72 fibres	■	1
0321 72	18 SC duplex multi-mode connectors for 36 fibres	■	1
0321 73	36 LC duplex single-mode connectors for 72 fibres	■	1
0321 74	18 SC duplex single-mode connectors for 36 fibres	■	1

0321 72

19" modular optic drawers

Sliding, equipped

0321 02	12 SC duplex multi-mode connectors for 24 fibres	■	1
0321 04	24 LC duplex multi-mode connectors for 48 fibres	■	1
0321 06	12 SC duplex single-mode connectors for 24 fibres	■	1

Sliding, to be equipped with fibre optic blocks

It can accept all fibre optic blocks; 4 blocks maximum

0321 00	Empty drawer	■	1
---------	--------------	---	---

0321 00

Bold Cat.Nos are products normally available with Legrand (India) Stockists. Cat.Nos that are not bold - delivery within 4 - 8 weeks from the date of order. Bold packing quantity is our mandatory packing. Orders to be placed by Legrand (India) Stockist in multiples of the same.

Legrand cabling system LCS³ fibre optic

Cat.Nos	Description	MRP* ₹ / Unit	Pack
---------	-------------	------------------	------

Fibre optic blocks

Singlemode fibre optic blocks (9/125 µm)

0321 17	ST block for 6 single-mode fibre optics	■	1
0321 10	SC duplex block for 6 single-mode fibre optics	■	1
0321 11	SC duplex high density block for 12 single-mode fibre optics	■	1
0321 12	SC APC duplex block for 6 single-mode fibre optics	■	1
0321 13	LC duplex block for 6 single-mode fibre optics	■	1
0321 14	LC duplex block for 12 single-mode fibre optics	■	1
0321 15	LC duplex high density block for 24 single-mode fibre optics	■	1
0321 16	LC APC duplex block for 12 single-mode fibre optics	■	1
0321 33	Single-mode 4 MTP ¹ feedthrough adapter	■	1



0321 15



0321 33

Multimode fibre optic blocks (62.5 and 50/125 µm)

0321 27	ST block for 6 multimode fibre optics	■	1
0321 20	SC duplex block for 6 multimode fibre optics	■	1
0321 21	SC duplex high density block for 12 multimode fibre optics	■	1
0321 23	LC duplex block for 6 multimode fibre optics	■	1
0321 24	LC duplex block for 12 multimode fibre optics	■	1
0321 25	LC duplex high density block for 24 multimode fibre optics	■	1
0321 34	Multimode 4 MTP ¹ feedthrough adapter	■	1



0321 21

Copper block for fibre optic drawer

0321 32	"It clips directly to the optic drawer to be equipped, Cat.No 0321 00 It gives the possibility of mixing fibre optic and copper"	■	1
---------	---	---	---

Accessories for optic drawer to be equipped

Accessory for receipt of a fan-out

0321 28	It's clipped at the back of the drawer It enables the entry of preterminated Cat.Nos	■	1
---------	---	---	---

Blank

0321 29	Blank block	■	1
---------	-------------	---	---

Pigtail cassette

0321 30	Capacity 24 fibre optics	■	1
---------	--------------------------	---	---

Coiling kit

0321 31	1 accessory	■	1
---------	-------------	---	---

Modular 19" panel to be equipped with cassettes

0321 40	Depth 190 mm, height 1 U	■	1
---------	--------------------------	---	---

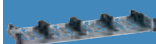

0321 40

* MRP - Maximum Retail Price Inclusive of all taxes including GST.

■ Price available on request.

1: MTP is a registered trademark of US Conec Ltd

Legrand cabling system LCS³ fibre optic

Cat.Nos	Description	MRP* ₹ / Unit	Pack
---------	-------------	------------------	------

Optic drawer cassettes

Fibre optic splice cassette

0321 41	It can accept all modular fibre optic blocks	■	1
---------	--	---	---



0321 41

Copper cassette to be equipped

0337 55	It can accept 6 cat. 5e, cat. 6 and cat. 6 _A connectors	■	1
---------	--	---	---

MTP¹ preterminated cassette (MPO compatible)

Front and rear extraction
High performance cassette, low insertion loss
<0.35 dB

0321 42	Multimode OM4 cassette (50/125 µm) 24 filaments LC OM4 Type A/C	■	1
0321 43	Multimode OM4 cassette (50/125 µm) 12 SC OM4 Type A/C	■	1
0321 44	Single-mode OS2 cassette (9/125 µm) type OS2 24 LC OS2 Type A/C	■	1
0321 45	Single-mode OS2 cassette (9/125 µm) 12 SC OS2 Type A/C	■	1

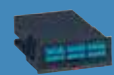

0321 43

Blanking cassette

0337 57	Used to blank the panel	■	1
---------	-------------------------	---	---

Adapters

0321 33	Single-mode 4 MTP ¹ adapter (installation in cassette 0 321 41)	■	1
0321 34	Multi-mode 4 MTP ¹ adapter (installation in cassette 0 321 41)	■	1

Accessories for 19" panel to be equipped with cassettes

0321 46	Rear cable management accessory For installation on panels Cat.No 0 321 40	■	1
0321 47	Cord management kit (guide/support/door)	■	1



0321 46

Pigtails

50/125 µm - OM2 (PC)

Connectors

0322 10	SC 1 m LSZH	■	10
0322 11	LC 1 m LSZH	■	10
0322 12	ST 1 m LSZH	■	10
0322 13	SC 2 m LSZH	■	10
0322 14	LC 2 m LSZH	■	10
0322 15	ST 2 m LSZH	■	10

Bold Cat.Nos are products normally available with Legrand (India) Stockists. Cat.Nos that are not bold - delivery within 4 - 8 weeks from the date of order. Bold packing quantity is our mandatory packing. Orders to be placed by Legrand (India) Stockist in multiples of the same.

Legrand cabling system LCS³ fibre optic

Cat.Nos	Description	MRP* ₹ / Unit	Pack
---------	-------------	------------------	------

50/125 µm - OM3 (PC)

Connectors

0322 20	SC 1 m LSZH	■	10
0322 21	LC 1 m LSZH	■	10
0322 22	ST 1 m LSZH	■	10
0322 23	SC 2 m LSZH	■	10
0322 24	LC 2 m LSZH	■	10

50/125 µm - OM4 (PC)

Connectors

0322 30	SC 1 m LSZH	■	10
0322 31	LC 1 m LSZH	■	10
0322 32	ST 1 m LSZH	■	10
0322 33	SC 2 m LSZH	■	10
0322 34	LC 2 m LSZH	■	10

9/125 µm - OS2 (APC or UPC) - OS1 compatible

Connectors

0322 40	SC-APC OS2 1 m LSZH	■	10
0322 41	SC-UPC OS2 1 m LSZH	■	10
0322 42	LC-APC OS2 1 m LSZH	■	10
0322 43	LC-UPC OS2 1 m LSZH	■	10
0322 44	ST-UPC OS2 1 m LSZH	■	10
0322 45	SC-APC OS2 2 m LSZH	■	10
0322 46	SC-UPC OS2 2 m LSZH	■	10
0322 47	LC-UPC OS2 2 m LSZH	■	10
0322 48	LC-APC OS2 2 m LSZH	■	10
0322 49	ST-UPC OS2 2 m LSZH	■	10

Set of 12 LC pigtails

0326 24	OS2 12 pigtails LC-UPC	■	1
0326 26	OM3 12 pigtails LC-PC	■	1
0326 71	OM4 12 pigtails LC-PC	■	1

Pigtail sleeves

0327 44	40 mm - bag of 50 sheaths	■	1
---------	---------------------------	---	---

Glue-on connectors 50/125 and 62.5/125 µm

0331 27	ST	■	10
0331 47	SC	■	10
0331 00	LC	■	10

Fan-out units

0330 48	6 fibre optic fan-out unit	■	1
0330 49	12 fibre optic fan-out unit	■	1

* MRP - Maximum Retail Price Inclusive of all taxes including GST.

■ Price available on request.

1: MTP is a registered trademark of US Conec Ltd

Legrand cabling system LCS³ fibre optic

Cat.Nos	Description	MRP* ₹ / Unit	Pack
---------	-------------	------------------	------

Tool case for the preparation of the fibre optic for quick-connect connectors

0322 70	It contains the tools required for the preparation of the fibre optic cable, for the completion of a first test to confirm the correct connection of the fibre optic to the connector, and the accessories for easy connection in all situations	■	1
---------	--	---	---

Quick-connect connectors

OM3/OM4 multimode connectors

Set of 12 connectors

0322 71	LC PC 50/125 µm, 900/250 µm	■	1
0322 72	SC PC 50/125 µm, 900/250 µm	■	1

OS2 single-mode connectors

Set of 12 connectors

0322 73	LC UPC 9/125 µm, 900/250 µm	■	1
0322 74	SC UPC 9/125 µm, 900/250 µm	■	1
0322 75	SC APC 9/125 µm, 900/250 µm	■	1

Precision cleaver for the update of the case kit Cat.No 0326 90

0322 80	It's used in conjunction with the kit of the case Cat.No 0 326 90, to cut the fibre optic with precision, and fit the quick-connect connectors, Cat.No 0 322 71 to 0 322 75	■	1
---------	---	---	---

Fibre optic cleaning accessories

0322 83	Ferrule cleaner MPO/MTP1	■	1
0322 81	Ferrule cleaner LC (PC/APC)	■	1
0322 82	Ferrule cleaner SC (PC/APC)	■	1
0322 84	LC replacement cartridge	■	1
0322 85	LC replacement cartridge	■	1

Fibre optic drawers with front facing cord management

0321 50	1 U	■	1
0321 52	2 U	■	1
0321 53	4 U	■	1
0321 51	UHD Panel to be equipped cassette without rear management 1 U	■	1

Very high density cassettes

Multimode OM4 cassette (50/125 µm)

For OM4 type 50/125 µm multimode installations

0321 54	MPO cassette 12 LC OM4 Type A/C	■	1
---------	---------------------------------	---	---

Bold Cat.Nos are products normally available with Legrand (India) Stockists. Cat.Nos that are not bold - delivery within 4 - 8 weeks from the date of order. Bold packing quantity is our mandatory packing. Orders to be placed by Legrand (India) Stockist in multiples of the same.

Legrand cabling system LCS³ fibre optic

Cat.Nos	Description	MRP* ₹ / Unit	Pack
---------	-------------	------------------	------

OS2 cassette (9/125 µm)

For OS2 type 9/125 µm multimode installations

0321 55	MPO cassette 12 LC OS2 Type A/C	■	1
---------	---------------------------------	---	---

MTP¹ adapters (MPO compatible)

They are clipped directly to the fibre optic drawers, Cat.Nos 0 321 50/51/52/53

0321 56	Multimode 4 MTP1 adapter	■	1
0321 57	Single-mode 4 MTP1 adapter	■	1

LC adapter

It's clipped directly to the fibre optic drawers, Cat.Nos 0 321 50/51/52/53

0321 58	Adapter 12 LC multimode	■	1
---------	-------------------------	---	---

Modular 19" panel to be equipped with cassettes

0321 40	Depth 190 mm, height 1 U	■	1
---------	--------------------------	---	---

High density MTP1 cassette (MPO compatible)

Fibre optic splice cassette

0321 41	It can accept all modular fibre optic blocks	■	1
---------	--	---	---

Copper cassette to be equipped

0337 55	It can accept 6 cat. 5e, cat. 6 and cat. 6A connectors	■	1
---------	--	---	---

Multimode OM4 cassettes (50/125 µm)

0321 42	MTP ¹ cassette (MPO compatible) 24 LC OM4 Type A/C	■	1
0321 43	MTP ¹ cassette (MPO compatible) 12 SC OM4 Type A/C	■	1

Single-mode OS2 cassettes (9/125 µm)

OS2 type

0321 44	MTP ¹ cassette (MPO compatible) 24 LC OS2 Type A/C	■	1
0321 45	MTP ¹ cassette (MPO compatible) 12 SC OS2 Type A/C	■	1

Blanking cassette

0337 57	Used to blank the panel	■	1
---------	-------------------------	---	---

MTP¹ adapters

It's installed in splice cassettes, Cat.No 0 321 41
It enables MTP¹/MTP¹ feedthrough

0321 33	Single-mode 4 MTP ¹ adapter	■	1
0321 34	Multimode 4 MTP ¹ adapter	■	1

* MRP - Maximum Retail Price Inclusive of all taxes including GST.

■ Price available on request.

1: MTP is a registered trademark of US Conec Ltd

Legrand cabling system LCS³ fibre optic preterminated solution

Cat.Nos	Description	MRP* ₹ / Unit	Pack
---------	-------------	------------------	------

Accessories for 19" panel to be equipped with cassette

0321 46	Rear cable management accessory For installation on panels Cat.No 0 321 40	■	1
0321 47	Cord management kit (guide/support/door)	■	1

High density preterminated fibre optic links

Micro cables OM3 Fan-out - Fan-out

Micro cables with spark gap, output 2 mm

0324 01	6 LC Duplex - 6 LC Duplex Length 10	■	1
0324 02	6 LC Duplex - 6 LC Duplex Length 20 (m)	■	1
0324 03	6 LC Duplex - 6 LC Duplex Length 30 (m)	■	1
0324 04	6 LC Duplex - 6 LC Duplex Length 40 (m)	■	1
0324 05	6 LC Duplex - 6 LC Duplex Length 50 (m)	■	1
0324 11	12 LC Duplex - 12 LC Duplex Length 10 (m)	■	1
0324 12	12 LC Duplex - 12 LC Duplex Length 20 (m)	■	1
0324 13	12 LC Duplex - 12 LC Duplex Length 30 (m)	■	1
0324 14	12 LC Duplex - 12 LC Duplex Length 40 (m)	■	1
0324 15	12 LC Duplex - 12 LC Duplex Length 50 (m)	■	1

Micro cables OS2 Fan-out - Fan-out

Micro cables with spark gap, output 2 mm

0324 21	6 LC Duplex - 6 LC Duplex Length 10 (m)	■	1
0324 22	6 LC Duplex - 6 LC Duplex Length 20 (m)	■	1
0324 23	6 LC Duplex - 6 LC Duplex Length 30 (m)	■	1
0324 24	6 LC Duplex - 6 LC Duplex Length 40 (m)	■	1
0324 25	6 LC Duplex - 6 LC Duplex Length 50 (m)	■	1
0324 31	12 LC Duplex - 12 LC Duplex Length 10 (m)	■	1
0324 32	12 LC Duplex - 12 LC Duplex Length 20 (m)	■	1
0324 33	12 LC Duplex - 12 LC Duplex Length 30 (m)	■	1
0324 34	12 LC Duplex - 12 LC Duplex Length 40 (m)	■	1
0324 35	12 LC Duplex - 12 LC Duplex Length 50 (m)	■	1

Bold Cat.Nos are products normally available with Legrand (India) Stockists. Cat.Nos that are not bold - delivery within 4 - 8 weeks from the date of order. Bold packing quantity is our mandatory packing. Orders to be placed by Legrand (India) Stockist in multiples of the same.

Legrand cabling system LCS³ cables

Cat.Nos	Description	MRP* ₹ / Unit	Pack
---------	-------------	------------------	------

Micro cables OM3 MTP1

0324 41	12 fibre optics - MTP ¹ -MTP ¹ Length 10 (m)	■	1
0324 42	12 fibre optics - MTP ¹ -MTP ¹ Length 20 (m)	■	1
0324 43	12 fibre optics - MTP ¹ -MTP ¹ Length 30 (m)	■	1
0324 44	12 fibre optics - MTP ¹ -MTP ¹ Length 40 (m)	■	1
0324 45	12 fibre optics - MTP ¹ -MTP ¹ Length 50 (m)	■	1

Micro cables OS2 MTP1

0324 51	12 fibre optics - MTP ¹ -MTP ¹ Length 10 (m)	■	1
0324 52	12 fibre optics - MTP ¹ -MTP ¹ Length 20 (m)	■	1
0324 53	12 fibre optics - MTP ¹ -MTP ¹ Length 30 (m)	■	1
0324 54	12 fibre optics - MTP ¹ -MTP ¹ Length 40 (m)	■	1
0324 55	12 fibre optics - MTP ¹ -MTP ¹ Length 50 (m)	■	1

OM 4 multimode fibre optic cables (50/125 µm)

"Bend insensitive"

For multimode installations 50/125 µm, type OM 4

Aqua sheaths

Suitable for 10 Giga Ethernet networks

Loose tube

0325 43	Indoor/outdoor (glass strands) 4 fibres - 2000 m	■	2000
0325 44	Indoor/outdoor (glass strands) 8 fibres - 2000 m	■	2000
0325 45	Indoor/outdoor (glass strands) 12 fibres - 2000 m	■	2000
0325 46	Outdoor, corrugated steel tape 4 fibres - 2000 m	■	2000
0325 47	Outdoor, corrugated steel tape 8 fibres - 2000 m	■	2000
0325 48	Outdoor, corrugated steel tape 12 fibres - 2000 m	■	2000

Tight structure 900 µm

0326 65	Indoor/outdoor (glass strands) 6 fibres - 500 m	■	2000
0326 66	Indoor/outdoor (glass strands) 6 fibres - 1000 m	■	2000
0326 67	Indoor/outdoor (glass strands) 12 fibres - 1000 m	■	2000
0326 68	Indoor/outdoor (glass strands) 24 fibres - 1000 m	■	2000

OS 2 single-mode fibre optic cables (9/125 µm) - (OS1 compatible)

For single-mode installations 9/125 µm,

type OS 2

Yellow or black sheaths for outdoor,
rodent guard...

Loose tube

0325 02	Indoor/outdoor (glass strands) 4 fibres	■	2000
0325 03	Indoor/outdoor (glass strands) 8 fibres	■	2000
0325 23	Outdoor, corrugated steel tape 4 fibres	■	2000

* MRP - Maximum Retail Price Inclusive of all taxes including GST.

■ Price available on request.

1: MTP is a registered trademark of US Conec Ltd

Legrand cabling system LCS³ cables

Cat.Nos	Description	MRP* ₹ / Unit	Pack
---------	-------------	------------------	------

Loose tube

0325 24	Outdoor, corrugated steel tape 8 fibres	■	2000
0325 25	Outdoor, corrugated steel tape 24 fibres	■	2000
0325 12	Indoor/outdoor (glass strands) 6 fibres	■	2000
0325 13	Outdoor, corrugated steel tape 6 fibres	■	2000
0325 14	Indoor/outdoor (glass strands) 12 fibres	■	2000
0325 15	Outdoor, corrugated steel tape 12 fibres	■	2000
0325 51	Indoor/outdoor (glass strands) 24 fibres	■	2000

Tight structure 900 µm

0325 50	Indoor/outdoor (glass strands) 12 fibres	■	2000
---------	---	---	------

OM 3 multimode fibre optic cables (50/125 µm)

"Bend insensitive"

For multimode installations 50/125 µm, type OM 3

Aqua sheaths

Suitable for 10 Giga Ethernet networks

Loose tube

0325 53	Indoor/outdoor (glass strands) 24 fibres	■	2000
0325 37	Indoor/outdoor (glass strands) 4 fibres	■	2000
0325 38	Indoor/outdoor (glass strands) 8 fibres	■	2000
0325 39	Indoor/outdoor (glass strands) 12 fibres	■	2000
0325 40	Outdoor, corrugated steel tape 8 fibres	■	2000
0325 41	Outdoor, corrugated steel tape 12 fibres	■	2000
0325 42	Outdoor, corrugated steel tape 24 fibres	■	2000

Tight structure 900 µm

0325 10	Indoor/outdoor (glass strands) 6 fibres	■	2000
0325 11	Indoor/outdoor (glass strands) 12 fibres	■	2000
0325 52	Indoor/outdoor (glass strands) 24 fibres	■	2000

OM 2 multimode fibre optic cables (50/125 µm)

For 50/125 µm multimode installations (OM 2)

Orange jacket or black for outdoor, corrugated

Loose tube

0325 04	Indoor/outdoor (universal) 6 fibres	■	2000
0325 05	Outdoor, corrugated steel tape 6 fibres	■	2000
0325 06	Indoor/outdoor (universal) 12 fibres	■	2000
0325 07	Outdoor, corrugated steel tape 12 fibres	■	2000

Bold Cat.Nos are products normally available with Legrand (India) Stockists. Cat.Nos that are not bold - delivery within 4 - 8 weeks from the date of order. Bold packing quantity is our mandatory packing. Orders to be placed by Legrand (India) Stockist in multiples of the same.

Legrand cabling system LCS³ fibre optic

Cat.Nos	Description	MRP* ₹ / Unit	Pack
900 µm Tight buffer			
0325 55	Indoor/outdoor (universal) 4 fibres	■	2000
0325 08	Indoor/outdoor (universal) 6 fibres	■	2000
0325 09	Indoor/outdoor (universal) 12 fibres	■	2000

0325 08

Legrand cabling system LCS³ patch cords

OS 1/OS 2 (UPC) single-mode optical cords

SC/SC duplex cords

0326 00	Length: 1 m	■	3
0326 01	Length: 2 m	■	3
0326 02	Length: 3 m	■	3

SC/LC duplex cords

0326 03	Length: 1 m	■	3
0326 04	Length: 2 m	■	3
0326 05	Length: 3 m	■	3

LC/LC duplex cords

0326 28	Length: 0.5 m	■	3
0326 06	Length: 1 m	■	3
0326 07	Length: 2 m	■	3
0326 08	Length: 3 m	■	3
0326 29	Length: 5 m	■	3

0326 07

LC/LC Uniboot duplex cords

Reversible polarity

0326 86	Length: 1 m	■	3
0326 87	Length: 2 m	■	3
0326 88	Length: 3 m	■	3
0326 89	Length: 5 m	■	3
0326 92	Length: 10 m	■	3

OM 4 multimode fibre optic cords (50/125 µm)

SC/SC duplex cords

0326 30	Length: 1 m	■	3
0326 31	Length: 2 m	■	3
0326 32	Length: 3 m	■	3

LC/LC duplex cords

0326 33	Length: 0.5 m	■	3
0326 34	Length: 1 m	■	3
0326 35	Length: 2 m	■	3
0326 36	Length: 3 m	■	3
0326 37	Length: 5 m	■	3

LC/LC Uniboot duplex cords

Reversible polarity

0326 95	Length: 1 m	■	3
0326 96	Length: 2 m	■	3
0326 97	Length: 3 m	■	3
0326 98	Length: 5 m	■	3
0326 99	Length: 10 m	■	3

* MRP - Maximum Retail Price Inclusive of all taxes including GST.

■ Price available on request.

1: MTP is a registered trademark of US Conec Ltd

Legrand cabling system LCS³ fibre optic preterminated solution

Cat.Nos	Description	MRP* ₹ / Unit	Pack
OM 3 multimode fibre optic cords (50/125 µm)			
SC/SC duplex cords			
0326 09	Length: 1 m	■	3
0326 10	Length: 2 m	■	3
0326 11	Length: 3 m	■	3



0326 13

SC/LC duplex cords

0326 12	Length: 1 m	■	3
0326 13	Length: 2 m	■	3
0326 14	Length: 3 m	■	3

LC/LC duplex cords

0326 15	Length: 1 m	■	3
0326 16	Length: 2 m	■	3
0326 17	Length: 3 m	■	3

OM 2 multimode fibre optic cords (50/125 µm)

ST/ST duplex cords

0330 80	Length: 1 m	■	3
0330 81	Length: 2 m	■	3
0330 82	Length: 3 m	■	3

SC/SC duplex cords

0330 69	Length: 1 m	■	3
0330 70	Length: 2 m	■	3
0330 71	Length: 3 m	■	3

ST/SC duplex cords

0330 72	Length: 2 m	■	3
0330 73	Length: 3 m	■	3

LC/LC duplex cords

0330 61	Length: 2 m	■	3
---------	-------------	---	---

SC/LC duplex cords

0330 75	Length: 1 m	■	3
0330 63	Length: 2 m	■	3
0330 76	Length: 3 m	■	3

LC/ST duplex cords

0330 65	Length: 2 m	■	3
---------	-------------	---	---

Fibre optic feedthrough sockets

2 x ST fibre optic feedthrough socket

Bayonet mount (STII compatible)

0786 16	White	■	1
---------	-------	---	---

2 x SC fibre optic feedthrough socket

"Push-pull" connection

0786 17	White	■	1
---------	-------	---	---

2 x LC fibre optic feedthrough socket

"Push-pull" connection

0786 18	White	■	1
---------	-------	---	---

Bold Cat.Nos are products normally available with Legrand (India) Stockists. Cat.Nos that are not bold - delivery within 4 - 8 weeks from the date of order. Bold packing quantity is our mandatory packing. Orders to be placed by Legrand (India) Stockist in multiples of the same.

LIGHTING MANAGEMENT SOLUTIONS

INTRODUCING SMART RANGE
OF STANDALONE SENSORS TO
PUT A STOP TO ENERGY WASTE



048953
PIR miniature



048955
Microwave



048806
Dual Technology

FEATURES



Dali Dimming
with on/off



Configuration
By App



Adjustable
Time delay



Day Light
harvesting



Occupancy/ Vacancy



Sensitivity
adjustment



Scan to know more about
the product.

Movement detectors

Cat.Nos	Description	MRP* ₹ / Unit	Pack
---------	-------------	------------------	------

Movement detectors for lighting control

IP 20-IP 55 movement detector with 180- 360° detection angle. For 2000 Watt incandescent, 230 V halogen," 1000 VA fluorescent



0488 06

0488 99	PIR ceiling detector sensor	5296	1/10
0488 06	Dual ceiling switch sensor 8.5A	11356	1/10
0488 07	PIR ceiling switch sensor 10A	11610	1/10
0488 17	Pir switch sensor corridor	13024	1/10
0488 04	PIR switch sensor 2 outputs	13256	1/10
0489 33	PIR WALL SWI. SENS. 270 degree	24958	1/10
0489 32	PIR ceiling mounted for warehouse	21658	1/10
0489 53	PIR ceiling mounted with DALI Dimming	17414	1/10
0489 54	PIR ceiling mounted	15142	1/10
0489 55	Microwave ceiling mounted with DALI dimming	19012	1/10
0489 59	PIR High bay sensor	24274	1/10
0488 75	Surface mount box	914	1/10
0882 40	Configuration gateway	26130	1/10



0489 53



0489 55

Video door entry systems

Cat.Nos	Description	MRP* ₹ / Unit	Pack
---------	-------------	------------------	------

Colour image digital video door entry system kit



3695 80



3695 70



3695 60



3695 50

3695 80	Basic video kit 7" hands free	16780	1
3695 70	Basic video kit 7" handset	17742	1
3695 60	Basic video kit 4.3" hands free	15396	1
3695 50	Basic video kit 4.3" handset	16450	1
3695 00	Basic audio kit handset	8538	1
3695 85	Basic video additional IU 7" hands free	9830	1
3695 75	Basic video additional IU 7" handset	11174	1
3695 65	Basic video additional IU 4.3" hands free	8832	1
3695 55	Basic video additional IU 4.3" handset	9846	1
3695 05	Basic audio additional handset	4878	1
3695 96	Basic additional video EP	7010	1
3695 95	Basic additional audio EP	4118	1
3695 97	Basic EP angle bracket	896	1

* MRP - Maximum Retail Price Inclusive of all taxes including GST.
Red Cat.Nos - new products

Bold Cat.Nos are products normally available with Legrand (India) Stockists. Cat.Nos that are not bold - delivery within 4 - 8 weeks from the date of order. Bold packing quantity is our mandatory packing. Orders to be placed by Legrand (India) Stockist in multiples of the same.



VIDEO DOOR ENTRY SYSTEM

IP SYSTEM FOR THE BEST PERFORMANCE

The ideal solution for large multiple-dwelling projects, able to guarantee high performance, long distances and high video signal quality.



Guard station

Entrance panel

Video indoor unit



Home + Security
The best App
for a safe home.



Scan to know more about the product.

CLASSE 300EOS

THE SMART VISION OF THE HOME.

Classe 300EOS is the new 2 wires / Wi-Fi handsfree connected video internal unit with built-in Amazon Alexa voice assistant. Using the Home + Security App, in addition to video door entry calls, it is also possible to manage the devices of the Legrand connected security solutions, creating a simple and fast Smart security system.

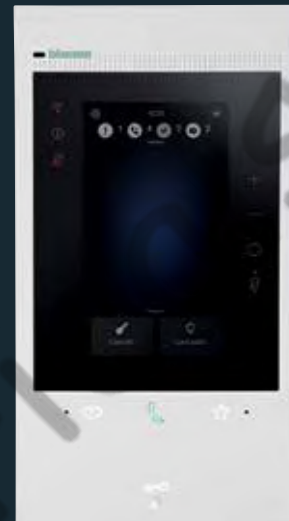

Home + Security
The best App
for a safe home.



Scan to know more about
the product.

P17 TEMPRA PRO

ALWAYS ENSURING
CONTINUITY OF SERVICE

By updating its IP44 and IP 66/67 range of industrial sockets, Legrand is meeting the expectations of professional users. New benefits in terms of safety, implementation, design & ergonomics guarantee the longevity of this family of products, which has already proven itself over time.



IP44

SOCKETS FOR INTERNAL AND EXTERNAL USE, PROTECTED AGAINST PROJECTIONS OF WATER (BUT NOT EXPOSED TO DIRECT JETS)



Straight plugs



Mobile sockets



Panel mounting sockets

A TRANSFORMED RANGE WHICH HARMONISES WITH THE LEGRAND INDUSTRIAL SOCKETS RANGE

- From 16 to 32 A
- 2 P+ E / 3 P+E / 3 P+N+E
- From 100 to 500 VA
- 50/60 Hz
- Screw connection



Scan to know more about the product.



AIRPORTS, DATA CENTRES,
HOTELS, ETC. P17 TEMPRA
PRO IS IDEAL FOR ALL MAJOR
PROJECTS

IP66/67/69*

WEATHERPROOF SOCKETS THAT
CAN WITHSTAND TEMPORARY
IMMERSION (RAIN, FLOODS, ETC)



Surface mounting
sockets



Straight plugs



Mobile sockets



Panel mounting
sockets



Surface mounting
sockets

- From 16 to 125 A
- 2 P+ E / 3 P+E / 3 P+N+E
- From 100 to 500 VA
- 50/60 Hz
- Screw connection

* On 63 and 125 A plugs and mobile sockets

P17 TEMPRA PRO

ENSURING EASE OF USE AND SAFETY

The new P17 Tempra Pro range has been subject to extensive research in terms of design and safety in order to make life safer and easier for the user. Good product gripping, compact dimensions for use in tight spaces, easier handling, etc. Compliance with standards, anti-corrosion treated materials and components, etc. A comprehensive set of solutions which comply with the standards.

AN INNOVATIVE DESIGN THAT COMPLIES WITH STANDARDS IEC 60309-1 AND 2 AND RESPECTS THE ENVIRONMENT

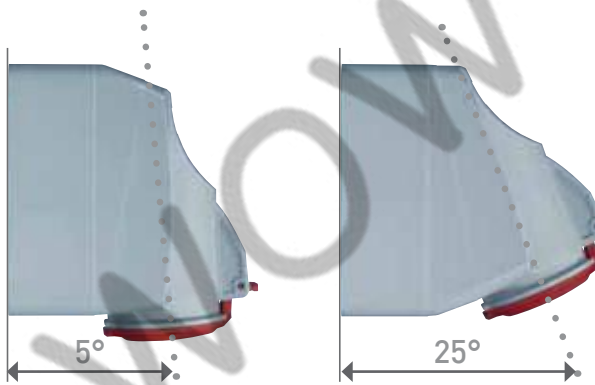

1 2 MOUNTING POSITIONS

To solve the problem of limited space, the surface mounting sockets offer 2 different mounting positions (5° or 25°) which allow users to adapt to the space available without changing the box.



2 CABLE GRIP

Captive cable grip with anti-vibration system holds the cable in place permanently. The 63 and 125 A products are also equipped with a locking screw.



3 EASE OF HANDLING

Gripping areas on the body of the mobile products and the cable grip.

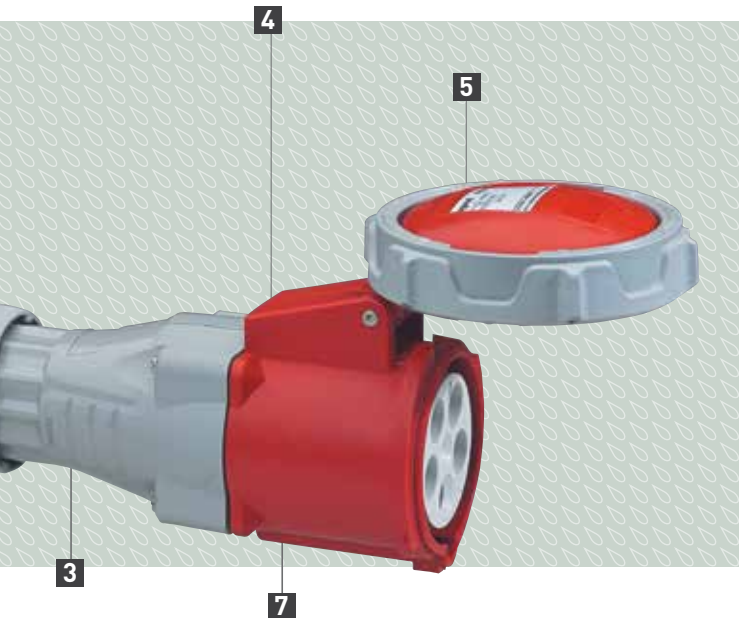

SAFETY & THE ENVIRONMENT

SAFETY

Connection terminals compliant with standards IEC 60 309 1 & 2

Production sites certified according to ISO 14001 and ISO 9001

Very high resistance to chemical products. Plugs and sockets made of polyamide 6

Anti-corrosion treated screws, stainless steel springs for the socket covers

Resistant to temperatures of -25°C to +40°C

ENVIRONMENT

Halogen-free recyclable materials (silicone, PVC) for IP 44 products

Grouped packaging in boxes

PEP products (Eco Passport)



4 OPENING LEVER

For easier connection / disconnection. Cover held open on panel sockets and surface mounting sockets.



5 POSITION MARKING

Information engraved on the ring cover of IP66/67 products means the user can check quickly whether it is in the open or closed position. Marking on cover and flap for easy identification.



6 RIVETED METAL SHAFT

For 63 and 125 A products the riveted metal shaft ensures more strength. The notched locking ring facilitates the locking / unlocking operations.



7 WEATHERPROOF SEALING

For panel mounting sockets.

P17 Tempra Pro IP 44 - LV 16 and 32 A - sockets and plugs

Cat.Nos	Description	MRP* ₹ / Unit	Pack
---------	-------------	------------------	------

Surface mounting sockets

5551 54	200/250 V~, 16 A 2P+E	780	10
5551 58	380/415 V~, 16 A 3P+E	962	10
5551 59	380/415 V~, 16 A 3P+N+E	1018	10
5552 54	200/250 V~, 32 A 2P+E	974	5
5552 58	380/415 V~, 32 A 3P+E	1220	10
5552 59	380/415 V~, 32 A 3P+N+E	1292	10

Panel mounting sockets inclined outlet

5551 84	200/250 V~, 16 A 2P+E	484	10
5551 88	380/415 V~, 16 A 3P+E	712	10
5551 89	380/415 V~, 16 A 3P+N+E	750	10
5552 84	200/250 V~, 32 A 2P+E	744	10
5552 88	380/415 V~, 32 A 3P+E	940	10
5552 89	380/415 V~, 32 A 3P+N+E	998	10

Mobile sockets

5551 04	200/250 V~, 16 A 2P+E	630	10
5551 08	380/415 V~, 16 A 3P+E	702	10
5551 09	380/415 V~, 16 A 3P+N+E	744	10
5552 14	200/250 V~, 32 A 2P+E	834	10
5552 18	380/415 V~, 32 A 3P+E	1002	10
5552 19	380/415 V~, 32 A 3P+N+E	1060	10

Straight plugs

5551 24	200/250 V~, 16 A 2P+E	446	10
5551 28	380/415 V~, 16 A 3P+E	546	10
5551 29	380/415 V~, 16 A 3P+N+E	576	10
5552 34	200/250 V~, 32 A 2P+E	672	10
5552 38	380/415 V~, 32 A 3P+E	768	10
5552 39	380/415 V~, 32 A 3P+N+E	814	10

P17 Tempra - domestic pin configuration 16 A - 250 VA

Flush-mounting boxes

0577 21	For 2 panel mounting sockets With single fixing centres 70 x 70 mm - 16 A	4456	3
0577 22	For 1 panel mounting socket With single fixing centres 70 x 70 mm - 16 or 32 A (32 A to be fixed horizontally)	2674	3

* MRP - Maximum Retail Price Inclusive of all taxes including GST.

P17 Tempra Pro IP 66/67 LV 16 and 32 A

Cat.Nos	Polarity	MRP* ₹ / Unit	Pack
---------	----------	------------------	------

Surface mounting sockets

5553 54	200/250 V~, 16 A 2P+E	1304	5
5553 58	380/415 V~, 16 A 3P+E	1452	5
5553 59	380/415 V~, 16 A 3P+N+E	1578	5
5554 54	200/250 V~, 32 A 2P+E	1546	5
5554 55	200/250 V~, 32 A 3P+E	2670	5
5554 59	380/415 V~, 32 A 3P+N+E	2894	5

Panel mounting sockets

5553 84	200/250 V~, 16 A 2P+E	954	5
5553 88	380/415 V~, 16 A 3P+E	1014	5
5553 89	380/415 V~, 16 A 3P+N+E	1078	5
5554 84	200/250 V~, 32 A 2P+E	1212	5
5554 88	380/415 V~, 32 A 3P+E	1388	5
5554 89	380/415 V~, 32 A 3P+N+E	1472	5

Mobile sockets

5553 04	200/250 V~, 16 A 2P+E	1168	5
5553 08	380/415 V~, 16 A 3P+E	1452	5
5553 09	380/415 V~, 16 A 3P+N+E	1540	5
5554 14	200/250 V~, 32 A 2P+E	1602	5
5554 18	380/415 V~, 32 A 3P+E	1712	5
5554 19	380/415 V~, 32 A 3P+N+E	1818	5

Straight plugs

5553 24	200/250 V~, 16 A 2P+E	1014	5
5553 28	380/415 V~, 16 A 3P+E	1114	5
5553 29	380/415 V~, 16 A 3P+N+E	1182	5
5554 34	200/250 V~, 32 A 2P+E	1374	5
5554 38	380/415 V~, 32 A 3P+E	1444	5
5554 39	380/415 V~, 32 A 3P+N+E	1530	5

P17 Tempra Pro IP 66/67 LV 32 A for refrigerated containers

Combined unit, plug and mobile socket for refrigerated containers

6571 06	Combined unit with interlocked switched socket - Double mechanical interlock - Cable glands are not supplied	20596	1
---------	--	-------	---

Bold Cat.Nos are products normally available with Legrand (India) Stockists. Cat.Nos that are not bold - delivery within 4 - 8 weeks from the date of order. Bold packing quantity is our mandatory packing. Orders to be placed by Legrand (India) Stockist in multiples of the same.

P17 Tempra Pro IP 66/67 LV 32 A for refrigerated containers

Cat.Nos	Polarity	MRP* ₹ / Unit	Pack
---------	----------	------------------	------

Combined unit, plug and mobile socket for refrigerated containers

5554 91	Panel mounting socket	■	5
5554 21	Mobile socket with cable grip Ø12 to 21.5 mm	■	5
5554 41	Straight plug With cable grip Ø12 to 21.5 mm		5



0573 00

P17 Tempra Pro IP 66/67 - LV 63 and 125 A

Surface mounting sockets

5555 54	200/250 V~, 63 A 2P+E	5392	2
5555 58	380/415 V~, 63 A 3P+E	5634	2
5555 59	380/415 V~, 63 A 3P+N+E	5954	2
5556 58	380/415 V~, 125 A 3P+E	15622	2
5556 59	380/415 V~, 125 A 3P+N+E	16558	2



5555 59

Panel mounting sockets

5555 84	200/250 V~, 63 A 2P+E	4276	2
5555 88	380/415 V~, 63 A 3P+E	4362	2
5555 89	380/415 V~, 63 A 3P+N+E	4594	2
5556 88	380/415 V~, 125 A 3P+E	12346	1
5556 89	380/415 V~, 125 A 3P+N+E	13200	1



5555 89

Straight plugs

5555 24	200/250 V~, 63 A 2P+E	3622	2
5555 28	380/415 V~, 63 A 3P+E	3678	2
5555 29	380/415 V~, 63 A 3P+N+E	4032	2
5556 28	380/415 V~, 125 A 3P+E	10952	1
5556 29	380/415 V~, 125 A 3P+N+E	11608	1



5555 29

Mobile sockets

5555 04	200/250 V~, 63 A 2P+E	4622	2
5555 08	380/415 V~, 63 A 3P+E	4798	2
5555 09	380/415 V~, 63 A 3P+N+E	5094	2
5556 08	380/415 V~, 125 A 3P+E	15942	1
5556 09	380/415 V~, 125 A 3P+N+E	16896	1



5555 09

Plugs and sockets

Cat.Nos	Polarity	MRP* ₹ / Unit	Pack
---------	----------	------------------	------

P17 combined unit to be equipped

Bases with mechanical super-compact sockets

0573 00	16 A, 2P+E IP 44 Interlock	5446	1
0573 02	16 A, 3P+N+E IP 44 Interlock	6010	1
0573 20	16 A, 2P+E IP 55 Interlock	6108	1
0573 22	16 A, 3P+N+E IP 55 Interlock	6874	1
0577 23	Mounting plate for 2 super-compact mechanical interlock sockets	3058	1

Bases for 125 x 220 mm face plates

Example of combined unit configuration

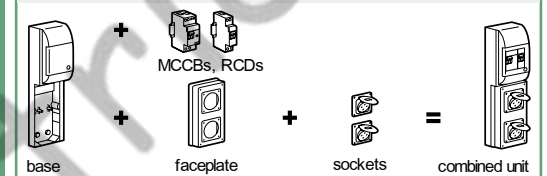

0577 10	Surface mounting box - upto 2 sockets	1274	2
0589 38	Surface mounting box with 5 module dinrail - upto 2 sockets	3560	1
0577 05	Surface mounting box with 12 module dinrail - upto 4 sockets	7862	1
0577 06	Surface mounting box with 18 module dinrail - upto 6 sockets	11006	1



0577 10



0577 05

Face plates 125 x 220 mm without sockets

0577 12	For 1 x 16 A or 32 - upto A socket	1208	5
0577 13	For 2 x 16 A - upto sockets	1516	5
0577 17	For 1 x 63 A - upto sockets	1392	5
0577 15	Blanking Plate	1024	5



Bases for 125 x 280 mm faceplates

0577 11	Surface mounting box - upto 3 sockets	1326	3
0577 20	Surface mounting box with 5 module dinrail - upto 3 sockets	3818	1
0577 03	Surface mounting box with 12 module dinrail - upto 6 sockets	8150	1
0577 04	Surface mounting box with 18 module dinrail - upto 9 sockets	11338	1



0577 11



0577 04

* MRP - Maximum Retail Price Inclusive of all taxes including GST.

Bold Cat.Nos are products normally available with Legrand (India) Stockists. Cat.Nos that are not bold - delivery within 4 - 8 weeks from the date of order. Bold packing quantity is our mandatory packing. Orders to be placed by Legrand (India) Stockist in multiples of the same.

Plugs and sockets

Cat.Nos	Polarity	MRP* ₹ / Unit	Pack
---------	----------	------------------	------

Face plates 125 x 280 mm without sockets

0577 18	For 2 x 16 A and / or 32 A sockets	1896	4
0577 19	For 1 x 16 A or 32 A socket and 1 x 63 A socket	1782	2
0577 14	For 3 x 16 A sockets	2160	4
0577 16	Blanking plate	1204	4

Hypra industrial plugs and sockets

Sockets

Prisinter panel mounting sockets - IP 44, IK 09

0520 02	230 V, 16 A, 2P+E	11086	1/10
0527 02	230 V, 32 A, 2P+E	12088	1/6
0529 03	415 V, 32 A, 3P+E	12332	1/6
0529 04	415 V, 32 A, 3P+N+E	14652	1/6
0536 04	415 V, 63 A, 3P+N+E	47176	1

Panel mounting sockets - inclined IP 44, IK 09

0522 23	415 V, 16 A, 3P+E	1794	5/50
0538 23	415 V, 63 A, 3P+E	5938	1

Mobile sockets - IP 44, IK 09

0522 83	415 V, 16 A, 3P+E	4312	5/50
---------	-------------------	------	------

Plugs

Straight plugs - IP 44, IK 09

0520 42	250 V, 16 A, 2P+E	1948	5/50
0527 42	250 V, 32 A, 2P+E	2404	1/5
0522 43	415 V, 16 A, 3P+E	3206	5/50
0529 43	415 V, 32 A, 3P+E	3216	5/50
0529 44	415 V, 32 A, 3P+N+E	3560	5/15
0538 43	415 V, 63 A, 3P+E	8496	1/5
0538 44	415 V, 63 A, 3P+N+E	11416	1/5

Metra plugs and sockets

Plugs

Ivory

6500 22	240 V, 10 A, 2P+E	214	1/5/100
6500 28	240 V, 20 A, 2P+E	226	1/5/100

Grey

6500 02	240 V, 10 A, 2P+E	214	1/5/100
6500 08	240 V, 20 A, 2P+E	226	1/5/100
6500 10	440 V, 20 A, 3P+E	300	1/5/100
6500 16	440 V, 32 A, 3P+E	562	1/5/100

Sockets

6500 03	240 V, 10 A, 2P+E With blue cap	218	1/5/100
6500 23	240 V, 10 A, 2P+E With ivory cap	218	1/5/100

* MRP - Maximum Retail Price Inclusive of all taxes including GST.

Hypra industrial plugs and sockets

Cat.Nos	Description	MRP* ₹ / Unit	Pack
---------	-------------	------------------	------

Sockets

6500 09	240 V, 20 A, 2P+E With blue cap	248	1/5/100
6500 29	240 V, 20 A, 2P+E With ivory cap	248	1/5/100
6500 11	440 V, 20 A, 3P+E With red cap	334	1/5/100
6500 17	440 V, 32 A, 3P+E With red cap	562	1/5/100

Plugs and sockets

P17 tempra combined units

With interlocked switched sockets and surface mounting box IP 44

0566 01	250 V, 16 A, 2P+E	8178	1
0566 09	250 V, 32 A, 2P+E	9756	1
0566 13	415 V, 32 A, 3P+E	11800	1
0566 14	415 V, 32 A, 3P+N+E	12388	1

With interlocked switched sockets and surface mounting box IP 55

0566 21	250 V, 16 A, 2P+E	9084	1
0566 29	250 V, 32 A, 2P+E	10378	1
0566 33	415 V, 32 A, 3P+E	13156	1
0566 34	415 V, 32 A, 3P+N+E	13396	1

With interlocked switched sockets and surface mounting box IP 44 with DIN rail for 5 module DX³ protection

0566 41	250 V, 16 A, 2P+E	8724	1
0566 49	250 V, 32 A, 2P+E	10612	1
0566 53	415 V, 32 A, 3P+E	11734	1
0566 54	415 V, 32 A, 3P+N+E	12556	1

With interlocked switched sockets and surface mounting box IP 66 with DIN rail for 5 module DX³ protection

0566 61	250 V, 16 A, 2P+E	9774	1
0566 69	250 V, 32 A, 2P+E	11340	1
0566 73	415 V, 32 A, 3P+E	12244	1
0566 74	415 V, 32 A, 3P+N+E	13234	1

With interlocked switched sockets and without surface mounting box IP 55

0572 21	250 V, 16 A, 2P+E	7862	1
0572 29	250 V, 32 A, 2P+E	8890	1
0572 33	415 V, 32 A, 3P+E	10556	1
0572 34	415 V, 32 A, 3P+N+E	11530	1
0572 95	415 V, 63 A, 3P+N+E, IP 66	25162	1
0577 00	Base box for 0572 95	4490	1

P17 tempra combined units

with interlocked switched sockets IP 66

0589 18	380 to 415 V, 50/60 Hz, 63 A, 3P + E with provision for 5 module DX ³ protection	26796	1
0572 99	380 to 415 V, 50/60 Hz, 63 A, 3P+N+E with provision for 5 module DX ³ protection	30196	1

Bold Cat.Nos are products normally available with Legrand (India) Stockists. Cat.Nos that are not bold - delivery within 4 - 8 weeks from the date of order. Bold packing quantity is our mandatory packing. Orders to be placed by Legrand (India) Stockist in multiples of the same.

LEGRAND

A GLOBAL EDIFICE

Legrand is global specialist in electrical and digital building infrastructures. The Group's headquarter is based at Limoges, France. Legrand (India), the pioneer of Miniature Circuit Breakers in India, is the Indian subsidiary of Legrand Group. The Group services the needs of residential, commercial, hospitality and industrial sectors.

- Manufacturing facilities in 90 countries and sale of products in 180 countries.
- World leader in wiring devices and cable management.
- The group designs and manufactures over 100 product families comprising of 3,00,000 products annually, with due emphasis on high performance, simplified installation and user convenience.
- Close to 1/3 of Legrand's capital expenditure is dedicated to the development of new products.
- Every year, Legrand invests around 4.8% of its global turnover on research and development activities involving over 2100 people worldwide.
- More than 100 showrooms around the globe.



Building trust with 38,200 employees



Sharing the legacy of over 6.9 billion euros turnover in the year 2021



Understanding you through 3,00,000 products



Partnering you with more than 4500 active patents

LEGRAND

GROUP VALUES



CUSTOMER
AWARENESS



INNOVATION



RESOURCE
ENHANCEMENT



ETHICAL
BEHAVIOUR



LEGRAND

PRESTIGIOUS PROJECTS

- Some of the prestigious projects we have been proud to associate with.
- The group services the needs of residential, commercial, hospitality and industrial projects.

NORTH

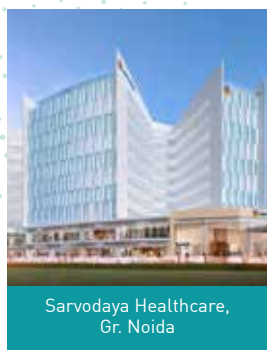

Sarvodaya Healthcare,
Gr. Noida



Ministry of Home Affairs,
New Delhi

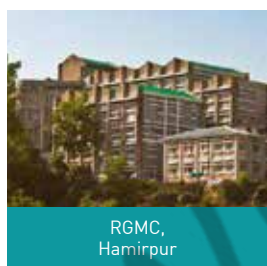

RGMC,
Hamirpur



Drinking Water Dept. UK,
Delhi

EAST

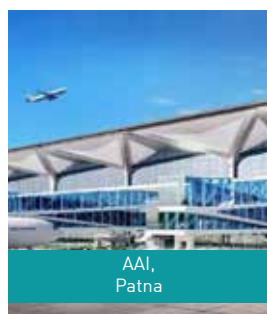

AAI,
Patna



KMRC,
Kolkata

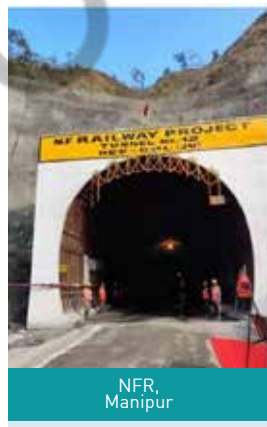

NER,
Manipur

WEST



IDFC,
Thane



Kothari Pipes,
Solapur



Adani,
Ahmedabad

SOUTH



Sparkle Realty,
Bangalore



PWD,
Madurai



IIT,
Palakkad

CENTRAL

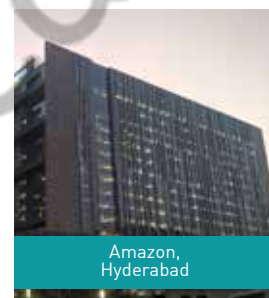

Amazon,
Hyderabad

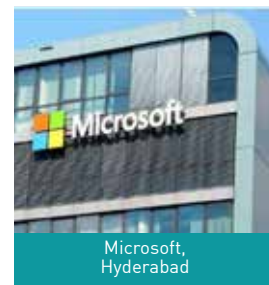

Microsoft,
Hyderabad

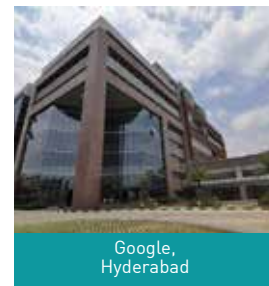

Google,
Hyderabad



KLU,
Hyderabad

Warranty policy

Legrand warrants to the original purchaser that the Products (excluding any third party products purchased through Legrand, for which no warranties are made) will be free from defects in material and workmanship, under normal use and regular service, and preventative maintenance for a period of 18 months from the date of shipment or 12 months from the date of installation whichever is earlier. Should any failure to conform with this warranty be found during the Warranty Period, you must notify Legrand of your claim within thirty (30) days of discovery, and within the Warranty Period. Your failure to give notice of claims of breach of warranty within the Warranty Period shall be deemed an absolute and unconditional waiver of claims for such defects. Legrand will have no responsibility to honour claims received after the date the applicable Warranty Period expires. The invoice / bill in original must be produced without which warranty claim shall not be entertained.

This warranty does not cover the following:

- Defect caused due to misuse, alteration, faulty installation, faulty electrical systems, negligent maintenance or misapplication of the product.
- Failure of product or components due to any act of nature; lightning strike, floods, hurricanes, tornadoes, etc. beyond the control of human being.
- Legrand does not warrant any third party products or associated hardware or their performance or suitability for use and application. Such items are provided "as-is".

Extended warranty policy is applicable for following products,

1. DX³ & RX³ MCB – 5 years if mounted inside Legrand DB
2. Arteor™, Myrius™, Myrius™ Regular, Mylinc™, Lyncus™, Allzy™, Britzy™ switches (without neon lamp) & Power sockets – 10 years
3. Arteor™, Myrius™, Myrius™ Regular, Mylinc™, Lyncus™, Allzy™, Britzy™ other products – 2 years
4. Arteor IoT & Myrius™ IoT - 2 years

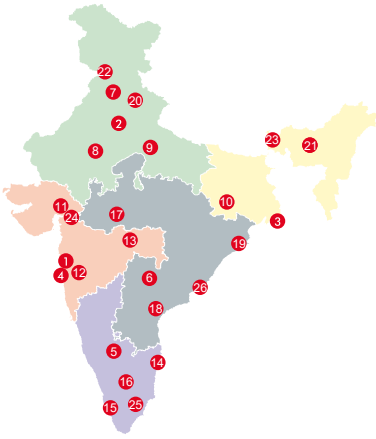

Head offices

- 61 & 62, 6th Floor,
Kalpataru Square, Kondivita Road,
Off Andheri-Kurla Road, Andheri (E),
MUMBAI – 400 059.
Tel.: (022) 3041 6200
Fax : (022) 3041 6201
Website : www.legrand.co.in

Regional sales offices

- B-225, 4th Floor, Okhla Industrial Area, Phase -1,
NEW DELHI - 110020.
Tel.: (011) 3990 2200, 2699 0046,
(011) 2699 0028 / 29 / 30 / 31
Fax : (011) 2699 0047 **INNOVAL**
- Bhakta Towers, 2nd & 3rd Floor,
Plot No. KB 22, Sector-III, Saltlake,
KOLKATA – 700 098.
Tel.: (033) 4021 3535
- C/203, Corporate Avenue, Atul Projects,
Near Mirador Hotel, Chakala,
Andheri - Ghatkopar Link Road,
Andheri – (E), **MUMBAI** – 400 099.
Tel.: (022) 6230 1000 **INNOVAL**
- Ferozes Manor, Situated at 58
Hospital Road, Shivaji Nagar,
BANGALORE – 560 001.
Tel.: (080) 80682 20000 **INNOVAL**
- Prestige Phoenix, 1st Floor,
Next to Lifestyle Building,
Begumpet, Hyderabad,
TELANGANA - 500 016 **INNOVAL**

Branch offices

- Unit No. 203, Tower B Bestech
Business Towers, Sector-66, Mohali,
CHANDIGARH - 160 017.
Tel.: (0172) 5019 008 **INNOVAL**
- Building No-128, Mansarovar Link Road,
Gopalpura Bypass, Mohan Nagar,
Near Ridhi Sidhi Flyover, **JAIPUR** - 302018
Tel.: 0141-2208665 **INNOVAL**
- 209-A, 2nd Floor, Cyber Heights,
Opp. Indira Gandhi Pratishthan,
Vibhuti Khand, Gomti Nagar,
LUCKNOW - 226 010.
Tel.: (0522) 431 9316 **INNOVAL**
- 202 & 203, Sunrise, Forum 100,
Burdwan Compound, Lalpur,
RANCHI - 834 001.
Tel.: (651) 660 5400
- A 101-102, Mondeal Heights,
Besides Novotel Hotel, Sarkhej
Gandhinagar Highway (S G Highway),
AHMEDABAD – 380 015.
Tel.: (079) 6134 0555 **INNOVAL**
- 8th Floor, Pinnacle Park Avenue,
Opp. Law College, Law College Road
Next To German Bakery,
Shivaji Nagar, **PUNE** - 411004.
Tel.: (020) 6729 5601 / 600 **INNOVAL**
- Plot No.95, 2nd Floor, Shreyash
Heights, VIP Road, Ramdaspath,
NAGPUR – 440 010.
Tel.: (0712) 2440 900
- 10 B, Prestige Center Court, Office Block,
Vijaya Forum Mall, #183, N.S.K. Salai,
Vadapatani, **CHENNAI** – 600 026.
Tel.: (044) 6612 2800 **INNOVAL**
- J. B. Manjooran Estate,
Door No. 50/1107 A9, 3rd Floor,
Bye Pass Junction, Edappally,
COCHIN – 682 024.
Tel.: (0484) 6604 700 **INNOVAL**
- 204-205, Megapolis Square,
579, M G Road,
INDORE – 452 001.
Tel.: (0731) 4999 891
- MF-2, Datta's Lords House,
Jammi Chettu Street, Mogalrajapuram,
VIJAYAWADA – 520 010.
Tel.: (0866) 248 2393/6393
- Plot No. 359, Saheed Nagar,
2nd Floor,
BHUBANESWAR – 751 007.
Tel.: (0674) 254 0623
- Unit - 1 & 2, Vijay Park,
Main Chakrata Road,
DEHRADUN- 248 001.
Uttarakhand.
Tel.: (0135) 661 6100 **INNOVAL**
- House No. 97, Ground Floor,
Rajgarh Main Road,
Opp. City Heart Nursing Home,
GUWAHATI – 781 007.

Area offices

- Cabin No. 9, 2nd Floor,
Madhok Trade Centre,
Madhok Complex, Ferozpur Road,
LUDHIANA – 141 001.
Tel.: (0161) 277 0301
- 94, Udhm Singh Sarani,
Ground Floor, Ashrampara,
SILIGURI – 734 001.
Tel.: (353) 264 1067
- A-207, Universal Business
Center, Near Madhuvan Circle,
L.P. Savani Road, Adajan,
SURAT – 395 009.
Tel.: (0261) 263 3861 **INNOVAL**
- Aparna Towers, 1st Floor, 2/3,
Bypass Road,
MADURAI – 625 010.
Telefax : (0452) 230 8414
- 43-9-205, 3rd Floor, Plot No. 10,
Subbalakshmi Nagar,
Opp. More Super Market,
VISAKHAPATNAM - 530 016.
Tel.: (0891) 273 5652 / 2739363 **INNOVAL**
- B-5, 1st Floor, Thirumalai Towers,
723, Avanashi Road,
COIMBATORE – 641 018.
Tel.: (0422) 668 3200 **INNOVAL**
- 515 & 516, Gera Imperium Grand,
Patto centre,
Panaji **GOA** – 403 001 **INNOVAL**
- 1st Floor, Cordial Bharathi,
Nanthancodu, Thiruvanthapuram,
KERALA- 695 003 **INNOVAL**

Technical assistance from Legrand

Telephonic technical assistance for selection of products, technical information, guidance, wiring diagrams and estimation is now made available to you at each Regional Office. Contact the Technical Officer of Legrand at the following telephone numbers

- New Delhi** : Tel.: (011) 2699 0028, 3990 2200
Kolkata : Tel.: (033) 4021 3535 / 36
Mumbai : Tel.: (022) 6230 1000
Chennai : Tel.: (044) 6612 2800
Hyderabad : Tel.: (040) 4567 1717

For other places, contact the nearest
Regional / Branch / Area offices

customer.care@legrand.co.in



LIVE THE ADVANTAGE