

Trusted partner for  
**Reliable**

**OWER**

**Low Voltage  
Power Distribution Products**

Price List w.e.f. 15<sup>th</sup> November 2022

**SIEMENS**

# LIST OF SITRAIN - INDIA TRAINING CENTERS

(including Training Service Providers, TSPs)

Code	Title	Location	Days
<b>SIMATIC – Classic STEP 7, Industry 4.0 and Process Instrumentation</b>			
AS-OL-400A	SIMATIC S7-400 with SIMATIC Manager (Advance Course)	Online Training	3 Days
DIGI-IN4.0	Introduction to Industry 4.0	Online Training	3 Days
AS-PI	Process Instrumentation	Online Training	4 Days
<b>TIA Portal Courses</b>			
AS-OL1500B	SIMATIC S7-1500 with TIA Portal V17 (Basic Course)	Online Training	5 Days
AS-1500B	SIMATIC S7-1500 with TIA V17 (Basic Course)	Siemens Ltd., Kalwa	5 Days
AS-1500A	SIMATIC S7-1500 with TIA V17 (Advance Course)	Siemens Ltd., Kalwa	5 Days
AS-OL1500A	SIMATIC S7-1500 with TIA Portal V17 (Advance Course)	Online Training	5 Days
AS-OL-WINT	SIMATIC WinCC SCADA (WinCC Prof) in the TIA Portal	Online Training	5 Days
AS-TIA150F	SIMATIC Distributed Safety on S7-1500F With TIA Portal <b>**New**</b>	Siemens Ltd., Kalwa	3 Days
<b>Process Control System SIMATIC PCS 7</b>			
AS-PCS7B	DCS: SIMATIC PCS 7 Basic	Siemens Ltd., Kalwa	10 Days
AS-PCS7A	DCS: SIMATIC PCS 7 Advance	Siemens Ltd., Kalwa	10 Days
AS-SFP	SIMATIC Fail-safe (Process Safety) Course <b>**New**</b>	Siemens Ltd., Kalwa	3 Days
<b>Drive &amp; Switchgear Technology</b>			
AP-CRANE	Application Based Crane Training	Siemens Ltd., Kalwa	5 Days
DR-S120B	SINAMICS S120 Basic	Siemens Ltd., Kalwa	5 Days
DR-S120A	SINAMICS S120 Advance	Siemens Ltd., Kalwa	5 Days
DR-SIMOB	SIMOTION Basic	Siemens Ltd., Kalwa	5 Days
LV-SM	SIMOCODE AC-Motor Control	Siemens Ltd., Kalwa	3 Days
TIA-MC	Basics of Motion Control 1 in TIA Portal <b>** New**</b>	Siemens Ltd., Kalwa	4 Days

Code	Title	Location	Days
<b>COMBO Courses <b>**New**</b></b>			
CO-CLS3040	SIMATIC S7-300 & S7-400 with SIMATIC Manager	Online Training	6 Days
CO-300WIN	SIMATIC S7-300 and WinCC v7.x	Online Training	6 Days
CO-TIA1215	SIMATIC S7-1200 & S7-1500 with TIA Portal	Online Training	6 Days
CO-TIAS120	SIMATIC S7-1500 PLC & SINAMICS S120	Online Training	6 Days
CO-G12S12	SINAMICS G120 & S120 Drives with STARTER	Online Training	6 Days
<b>Maintenance Focused Course <b>**New**</b></b>			
MFC-G13S12	SINAMICS G130 & S120	Siemens Ltd., Kalwa	5 Days
MFC-R70R80	DC DRIVE 6RA70 & 6RA80	Siemens Ltd., Kalwa	5 Days
MFC-S7400	SIMATIC S7-400 with SIMATIC Manager	Siemens Ltd., Kalwa	3 Days
MFC-S71500	SIMATIC S7-1500 with TIA Portal	Siemens Ltd., Kalwa	3 Days
<b>Blended Training <b>**New**</b></b>			
BT-1500	Blended Training on SIMATIC S7 1500 with TIA Portal	Online Training	45 Hrs.

Kindly download the SITRAIN app on your mobile from following link for course details

- For Android users:  
<https://play.google.com/store/apps/details?id=com.siemens.industry.onlinesupport>
- For Apple users:  
<https://apps.apple.com/in/app/industry-online-support/id478868966>

## SITRAIN Training in India

### SITRAIN India (Kalwa)

Siemens Ltd.  
TSDC, Kalwa Works  
Opposite Airoli Railway Station  
Thane Belapur Road, Airoli  
Navi Mumbai - 400708, Maharashtra  
Tel: +91-22-39663208  
E-mail: customer.training.in@siemens.com



# Index

Contents	Page No.
<b>1 Air Circuit Breakers</b>	<b>4-11</b>
Air circuit breakers - SENTRON 3WA <b>NEW</b>	7
Air circuit breakers - SENTRON 3WL <b>Plus</b>	8
Accessories for SENTRON 3WL <b>Plus</b> ACBs	8
Air circuit breakers - SENTRON 3WT <b>Plus</b>	10
Accessories for SENTRON 3WT <b>Plus</b> ACBs	11
Air circuit breakers - 3WJ <b>NEW</b>	12
<b>2 Moulded Case Circuit Breakers</b>	<b>14-38</b>
Moulded case circuit breakers - SENTRON 3VA	15
Accessories for 3VA	21
Moulded case circuit breaker - SENTRON 3VA27	22
Moulded case circuit breakers - SENTRON 3VM	25
Accessories for 3VM	30
Moulded case circuit breakers - 3VT2...3	31
Accessories for 3VT2...3	31
Moulded case circuit breakers - 3VT4...5	32
Accessories for 3VT4...5	32
Moulded case circuit breakers - SINOVA 3VJ	34
Accessories for 3VJ	38
<b>3 SIMARIS software tools</b>	<b>23</b>
<b>4 Automatic transfer controller - SENTRON ATC 3100/6300/6500</b>	<b>39-40</b>
<b>5 Load Break Switches</b>	<b>41-53</b>
Fuse switch disconnecter - 3NP1	42
Switch disconnecter fuse - 3KL8 (4P/3PN/3P)	45
Switch disconnecter fuse - 3KL8 (2P)	46
Switch disconnecter fuse in SS housing - 3KL8 (3PN/4P)	46
Switch disconnecter - 3KA8 (2P/3PN/4P)	47
Accessories for 3KL8/ 3KA8 (2P/3P/3PN/4P)	47
On Load Changeover Switch - SINOVA 3KJ	49
Main control & emergency stop switches - 3LD2	52
Accessories for 3LD2	53
Rotary Switches - 3LA0	53
<b>6 SIVACON S8</b>	<b>51</b>
<b>7 Control switches - 3LD4</b>	<b>54-60</b>
ON OFF Switches	55
Instrumentation Selector Switch	55
Changeover Switch	56
Phase Changeover Switch (PCS)	56
Breaker Control Switch <b>NEW</b>	57
Multistep Switch	57

Contents	Page No.
<b>8 Energy Management System</b>	<b>61-69</b>
Power Monitoring Devices SENTRON 7KM PAC 3120 / 3220 / 4200	62
Energy Management Software: SENTRON powermanager	62
SENTRON 7KN Powercenter 3000	63
Power Quality Measurement SENTRON 7KM PAC 5200	64
DIN rail mounted meters SENTRON 7KM PAC 2200/ 3200T / 7KT PAC1600	65
SENTRON 7KT PAC1200 - Multichannel current measuring system	66
Power Monitoring Devices <b>NEW</b> SMART 7KT	69
<b>9 Power Quality Solutions - PQS</b>	<b>70-75</b>
LV Power Capacitors - SIECAP™ 4RB	71
Harmonics filter detuned reactor	74
Capacitor duty contactors - 3TS / 3MT	75
Automatic power factor correction relay - APFCR	75
<b>10 Numerical Relays and Auxiliary Relays</b>	<b>76-78</b>
<b>11 Arc Fault Detection Device</b>	<b>79</b>
<b>12 Betagard Circuit Protection Devices</b>	<b>80-81</b>
Betagard Miniature Circuit Breakers - 5SL6/5SL4	80
Betagard Circuit Breakers - 5SL7/5SL5	81
<b>13 Fuses</b>	<b>82 - 88</b>
DIN fuses - 3NA / Fuse bases (DIN)	83
DIN isolating links - 3NG	83
SENTRON 3NA COM LV HRC fuse link	84
BS fuses - 3NW	85
Fuse holders and accessories for fuses - 3NW	85
Fuses for semiconductor protection - 3NE/ 3NC	86
Cylindrical fuses - 3NW	88
<b>14 SSD Surge Protection Device</b>	<b>89</b>
<b>15 INDUSTRY 4.0</b>	<b>90</b>
<b>16 Type-2 Co-ordination Charts</b>	<b>91-94</b>
<b>17 SENTRON Digitalization solutions</b>	<b>96-97</b>
<b>18 Available till stocks last</b>	<b>98</b>
<b>19 Discontinued products</b>	<b>99</b>
<b>20 Contact Partners</b>	<b>100</b>
Customer care	100
Training centres	Front cover inside
Terms and conditions	101
Offices and territory managers	Back cover



# | 3WA air circuit breakers

## Made for makers. Simply reliable

Fail-safe power distribution is a job for makers. The 3WA air circuit breaker makes sure you get the job done reliably.

3WA air circuit breakers continue Siemens' tradition of switchgear innovation and bring power distribution into the digital age. Whether you are quality-conscious, efficient, future-, or system-oriented: The 3WA air circuit breaker will be the new central component in your panel.

[siemens.com/3wa](https://www.siemens.com/3wa)



Scan for more info



Future ready



Easy operation



Advanced connectivity

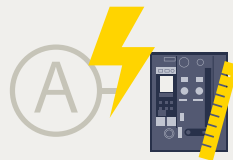

Smallest footprint



Shorter downtime



Efficient metering



Easy upgrade



Enhanced safety



Cyber security



High system availability



# 3WA air circuit breakers

## The future of digital power distribution

The future will be connected.

The makers of tomorrow will require advanced diagnostics and safety during operation. They will need access to their power distribution system remotely and securely. With 3WA we invite you to a more connected and sustainable tomorrow.

Welcome to the future of digital power distribution.

[siemens.com/3wa](https://www.siemens.com/3wa)

**SIEMENS**

# ACB: SENTRON 3WA NEW

- Conforms to IEC 60947-2
- Rated current - 630A to 6300A
- Short circuit breaking capacity upto 150kA
- Fully rated upto 55°C with 100% rated neutral
- Best in class endurance
- Upgradeable ETU with unique dual processor
- Industry leading diagnostic & testing features
- Cybersecure communication module with dual communication
- Advanced metering as per IEC 61557-12

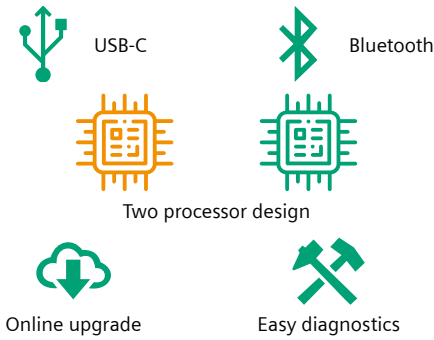

Standard breaking capacity  $I_{cs} = 100\% I_{cu}$

Manually operated ACB

Microprocessor based trip unit ETU600 with LSING<sup>1)</sup> protection

Frame Size	Rated Current In (A)	Type	Withdrawable <sup>2)</sup> design with Guide Frame		Fixed <sup>3)</sup> mounted design	
			Unit LP* ₹	Unit LP* ₹	Unit LP* ₹	Unit LP* ₹
			3 Pole	4 Pole	3 Pole	4 Pole
I	630	3WA1106....	POR	POR	POR	POR
	800	3WA1108....				
	1000	3WA1110....				
	1250	3WA1112....				
	1600	3WA1116....				
II	2000	3WA1220....	POR	POR	POR	POR
	2500	3WA1225....				
	3200	3WA1232....				
	4000	3WA1240....				
III	5000	3WA1350....	POR	POR	POR	POR
	6300	3WA1363....				

L: Overload protection      S: Delayed Short Circuit protection      I: Short circuit protection  
 G: Ground fault protection      N: Neutral protection

Note: Std. Pkg. = 1 unit

- 1) Current transformer for N-conductor shall be ordered separately for 3P ACB with Earth Fault and Neutral Conductor Protection.
- 2) Standard Accessories included for draw out type ACB (EDO/MDO) = Safety shutter, door sealing frame, Spring charge, ready to close signal switch, auxiliary contacts 2NO+2NC, trip unit transparent cover & trip signal switch (Not applicable for ACBs without trip unit).
- 3) Standard accessories included for fixed type ACB (EF/MF) = Door sealing frame Spring charge, ready to close signal switch, auxiliary contacts 2NO+2NC, trip unit transparent cover & trip signal switch (Not applicable for ACBs without trip unit)

Prices of ACBs with other breaking capacities, 1000/1150V AC applications & DC applications available on request

### Add-on options (Factory fitted)

Description	Add LP* ₹
Door Interlock	POR
Position Signal Switch for Withdrawable Breaker	
Castell lock mounting kit <sup>#</sup>	
Mutual Mechanical Interlocking (Bowden wire)	
PROFINET / MODBUS TCP Communication module	

# Castell locks are to be ordered separately.

Please contact your nearest Siemens Sales Office for complete ordering code.

Motorised Mechanism	Add LP* ₹
208-240VAC, 220Vdc motor, closing coil & Shunt trip coil	POR
110-127VAC, 110Vdc motor, closing coil & Shunt trip coil	

Motorized mechanism with other control voltages are available on request



## Accessories

Description	AC 50/60Hz V	DC V	Type	Unit LP* ₹
Shunt Release or Closing Coil Suitable for continuous operation	-	24	3WA9111-0AD02	18270.-
	110	110	3WA9111-0AD05	18270.-
	230	220	3WA9111-0AD06	18270.-
Under Voltage Release (Instantaneous)	380-415	-	3WA9111-0AE07	20195.-
Motorised Operating Mechanism	-	24-30	3WA9111-0AF02	101010.-
	110-127	110-125	3WA9111-0AF05	101010.-
	208-240	220-250	3WA9111-0AF06	101010.-
Castell Lock	-	-	3WX3663-6JEL_ <sup>s</sup>	5715.-

Please order necessary auxiliary terminal blocks as per circuit diagram while ordering accessories. Please contact your nearest Siemens Sales Office for type nos. and prices.

\$ Types of castell locks shall be of type A, B, C, D, AB, AC; \_ to be replaced by the type no.

Std. Pkg. = 1 unit

POR: Price On Request

\* LP - List Price

## ACB: SENTRON 3WL *Plus*

- Conforms to IEC 60947-2
- Rated current - 630A to 6300A
- Accurate protection through microprocessor based trip unit
- Unique ready-to-close interlock for maximum safety
- Mechanical contact erosion indicator
- Fully rated upto 55°C
- Neutral 100% rated
- Integrated online test facility
- Unique CubicleBus technology
- Data communication and power management options



Standard breaking capacity  $I_{cs} = 100\% I_{cu}$

Manually operated ACB

Microprocessor based trip unit ETU45B LSIN protection (Overload and short circuit protection)

Frame Size	Rated Current In (A)	Type	Withdrawable design with Guide Frame		Fixed mounted design	
			Unit LP* ₹	Unit LP* ₹	Unit LP* ₹	Unit LP* ₹
			3 Pole	4 Pole	3 Pole	4 Pole
I	630	3WL1106....	429905.-	543065.-	283690.-	425555.-
	800	3WL1108....	434610.-	553735.-	292420.-	436405.-
	1000	3WL1110....	446075.-	592040.-	320920.-	460885.-
	1250	3WL1112....	540055.-	683020.-	394745.-	562585.-
	1600	3WL1116....	595460.-	750295.-	417785.-	606020.-
II	2000	3WL1220....	658995.-	834685.-	466450.-	667880.-
	2500	3WL1225....	740920.-	970580.-	474255.-	727340.-
	3200	3WL1232....	959855.-	1318245.-	656155.-	1104465.-
	4000	3WL1240....	1104130.-	1402065.-	893215.-	1210465.-
III	5000	3WL1350....	1824020.-	2314245.-	1628305.-	2137420.-
	6300	3WL1363....	2452205.-	3081500.-	2125740.-	2803030.-

Prices of ACBs with other breaking capacities available on request.

L: Overload protection      S: Delayed Short Circuit protection      I: Short circuit protection  
G: Ground fault protection      N: Neutral protection

Note: Std. Pkg. = 1 unit

### Add-on options (Factory fitted)

Microprocessor based Release	Add LP* ₹
For ground fault protection	31915.-
Protection function LSIN with Current display	15255.-
Protection function LSING with Current display	45755.-

For prices of breakers with other types of microprocessor based trip unit, please contact your nearest Siemens Sales Office

Motorised Mechanism	Add LP* ₹
208-240VAC, 220Vdc motor, closing coil & Shunt trip coil	117255.-
110-127VAC, 110Vdc motor, closing coil & Shunt trip coil	117255.-

Motorized mechanism with other control voltages are available on request

All ACBs are with Top Horizontal - Bottom Horizontal main terminals except 6300A & 4000A which have only Vertical-Vertical main termination.

Standard Accessories included for draw out type ACB (EDO/MDO) = Safety shutter, door sealing frame, ready to close signal switch, auxiliary contacts 2NO+ 2NC and trip unit transparent cover & trip signal switch (Not applicable for ACBs without trip unit).

Standard accessories included for fixed type ACB (EF/IF) = Door sealing frame, ready to close signal switch, auxiliary contacts 2NO+2NC and trip unit transparent cover & trip signal switch (Not applicable for ACBs without trip unit)

Neutral CT if required, shall be ordered separately. \*Castell locks are to be ordered separately.

Please contact your nearest Siemens Sales Office for complete ordering code.

### Add-on options (Factory fitted)

Description	Add LP* ₹
Spring Charge Signal Switch	10115.-
Door Interlock	8565.-
Position Signal Switch for Withdrawable Breaker	22180.-
Castell lock mounting kit*	7220.-
Mutual Mechanical Interlocking (Bowden wire)	POR
Metering function Plus (voltage transformer must be ordered separately)	
Profibus communication connection (COM15 + BSS)	
Modbus communication connection (COM16 + BSS)	
Modbus TCP/PROFINET communication connection (COM35 + BSS) <b>NEW</b>	

ACB for 1000/1150 V AC operation and DC application available on request

## Accessories

Description	AC 50/60Hz V	DC V	Type	Unit LP* ₹
Shunt Release or Closing Coil Suitable for continuous operation	-	24	3WA9111-0AD02	18270.-
	110	110	3WA9111-0AD05	18270.-
	230	220	3WA9111-0AD06	18270.-
Under Voltage Release (Instantaneous)	380-415	-	3WA9111-0AE07	20195.-
Motorised Operating Mechanism	-	24-30	3WA9111-0AF02	101010.-
	110-127	110-125	3WA9111-0AF05	101010.-
	208-240	220-250	3WA9111-0AF06	101010.-
Auxiliary Switch Block	2NO+2NC		3WL9111-0AG01-0AA0	13035.-
Castell Lock	-	-	3WX3663-6JEL_ <sup>s</sup>	5715.-

Please order necessary auxiliary terminal blocks as per circuit diagram while ordering accessories. Please contact your nearest Siemens Sales Office for type nos. and prices.

\$ Types of castell locks shall be of type A, B, C, D, AB, AC; \_ to be replaced by the type no.

Std. Pkg. = 1 unit

POR: Price On Request

\* LP - List Price





# SENTRON 3WT<sup>Plus</sup> Air Circuit Breakers

Powering smart installations

- Integrated communication and metering option
- Easy parameterization and diagnostics with Powerconfig



[www.siemens.co.in](http://www.siemens.co.in)

**SIEMENS**

# ACB: 3WT<sup>Plus</sup>



- Conforms to IEC 60947-2
- Rated current - 630A to 4000A
- $U_{imp} = 12kV$
- **Integrated communication & metering option**
- **Easy parameterization and diagnostics with Powerconfig**
- Mechanical contact erosion indicator
- Fully rated upto 50°C
- Integrated LCD display and Online test facility
- Variants available for 690V AC applications

## Standard breaking capacity, 500VAC $I_{cs} = 100\% I_{cu}$

Microprocessor based trip unit ETU37WT: LSING<sup>1)</sup> + Display

Frame Size	Rated current In (A)		Withdrawable design with Guide Frame <sup>2)</sup>				
			3 Pole	Unit LP* ₹	4 Pole	Unit LP* ₹	
I	630	MDO	3WT8061-6AA04-5AB2	306835.-	3WT8065-6AA04-5AB2	398895.-	
		EDO	3WT8061-6UA34-5AB2	396885.-	3WT8065-6UA34-5AB2	488945.-	
	800	MDO	3WT8081-6AA04-5AB2	323825.-	3WT8085-6AA04-5AB2	423905.-	
		EDO	3WT8081-6UA34-5AB2	413875.-	3WT8085-6UA34-5AB2	513955.-	
	1000	MDO	3WT8101-6AA04-5AB2	332615.-	3WT8105-6AA04-5AB2	431445.-	
		EDO	3WT8101-6UA34-5AB2	422665.-	3WT8105-6UA34-5AB2	521495.-	
	1250	MDO	3WT8121-6AA04-5AB2	408550.-	3WT8125-6AA04-5AB2	485685.-	
		EDO	3WT8121-6UA34-5AB2	498600.-	3WT8125-6UA34-5AB2	575735.-	
	● 1600	MDO	3WT8161-6AA04-5AB2	438485.-	3WT8165-6AA04-5AB2	530800.-	
		EDO	3WT8161-6UA34-5AB2	528535.-	3WT8165-6UA34-5AB2	620850.-	
	II	● 2000	MDO	3WT8202-6AA04-5AB2	550920.-	3WT8206-6AA04-5AB2	678050.-
			EDO	3WT8202-6UA34-5AB2	640970.-	3WT8206-6UA34-5AB2	768100.-
● 2500		MDO	3WT8252-6AA04-5AB2	624035.-	3WT8256-6AA04-5AB2	793360.-	
		EDO	3WT8252-6UA34-5AB2	714085.-	3WT8256-6UA34-5AB2	883410.-	
● 3200		MDO	3WT8322-6AA04-5AB2	800045.-	3WT8326-6AA04-5AB2	981665.-	
		EDO	3WT8322-6UA34-5AB2	890095.-	3WT8326-6UA34-5AB2	1071715.-	

### Microprocessor based Trip Units

ETU35WT: LSI + Display



5

Reduce

1235.-



5

Reduce

1235.-

Microprocessor based trip unit ETU37WT: LSING<sup>1)</sup> + Display

Frame Size	Rated current In (A)		Fixed Mounted design <sup>3)</sup>				
			3 Pole	Unit LP* ₹	4 Pole	Unit LP* ₹	
I	630	MF	3WT8061-6AA00-0AA2	225480.-	3WT8065-6AA00-0AA2	305060.-	
		EF	3WT8061-6UA30-0AA2	315530.-	3WT8065-6UA30-0AA2	395110.-	
	800	MF	3WT8081-6AA00-0AA2	243390.-	3WT8085-6AA00-0AA2	334890.-	
		EF	3WT8081-6UA30-0AA2	333440.-	3WT8085-6UA30-0AA2	424940.-	
	1000	MF	3WT8101-6AA00-0AA2	248115.-	3WT8105-6AA00-0AA2	354770.-	
		EF	3WT8101-6UA30-0AA2	338165.-	3WT8105-6UA30-0AA2	444820.-	
	1250	MF	3WT8121-6AA00-0AA2	337485.-	3WT8125-6AA00-0AA2	399085.-	
		EF	3WT8121-6UA30-0AA2	427535.-	3WT8125-6UA30-0AA2	489135.-	
	● 1600	MF	3WT8161-6AA00-0AA2	344590.-	3WT8165-6AA00-0AA2	427485.-	
		EF	3WT8161-6UA30-0AA2	434640.-	3WT8165-6UA30-0AA2	517535.-	
	II	● 2000	MF	3WT8202-6AA00-0AA2	387540.-	3WT8206-6AA00-0AA2	556320.-
			EF	3WT8202-6UA30-0AA2	477590.-	3WT8206-6UA30-0AA2	646370.-
● 2500		MF	3WT8252-6AA00-0AA2	437445.-	3WT8256-6AA00-0AA2	653165.-	
		EF	3WT8252-6UA30-0AA2	527495.-	3WT8256-6UA30-0AA2	743215.-	
● 3200		MF	3WT8322-6AA00-0AA2	666040.-	3WT8326-6AA00-0AA2	820265.-	
		EF	3WT8322-6UA30-0AA2	756090.-	3WT8326-6UA30-0AA2	910315.-	

### Microprocessor based Trip Units

ETU35WT: LSI + Display



5

Reduce

1235.-



5

Reduce

1235.-

**For Non-Automatic ACBs please deduct ₹ 2810/- from the LPs of the ACBs marked ●.** For type nos. of Non-Automatic ACBs please contact your nearest Siemens Sales Office

L: Overload protection S: Delayed Short Circuit protection

I: Short circuit protection

G: Ground fault protection<sup>1)</sup>

N: Neutral protection<sup>1)</sup>

Standard accessories included for electrical ACB (EDO/EF) = Motor operated mechanism, with mechanical and electrical closing, motor and closing solenoid of 220-240V AC/DC and shunt release of 220-240V AC/DC.

<sup>1)</sup> Current transformer for N-conductor shall be ordered separately for 3P ACB with Earth Fault and Neutral Conductor Protection.

<sup>2)</sup> Standard Accessories included for draw out type ACB (EDO/MDO) = Safety shutter, sealing cap over Off button, door sealing frame, trip unit transparent cover, trip signaling contact, ready to close signaling contact, auxiliary contacts 2NO+ 2NC

<sup>3)</sup> Standard accessories included for fixed type ACB (EF/MF) = Door sealing frame, trip unit transparent cover, trip signaling contact, ready to close signaling contact, auxiliary contacts 2NO+2NC

**Note: Please contact your nearest Siemens Sales Office for information on prices of 4000A ACB.**

**Additional LP for 690V AC ACB - ₹ 40785/-**

Std. Pkg. = 1 unit

\* LP - List Price

Circuit Breakers

## 3WT<sup>Plus</sup> Accessories

Description	AC 50/60Hz V	DC V	Type	Unit LP* ₹
Motorized Operating Mechanism with Electrical closing	110-127	110-125	3WT9831-1JH00	96630.-
	220-240	220-250	3WT9831-1JK00	96630.-
Shunt Release or Closing Coil Suitable for continuous operation	-	24	3WT9851-1JB00	8275.-
	110-127	110-125	3WT9851-1JH00	8275.-
	220-240	220-250	3WT9851-1JK00	8275.-
Under Voltage Release Instantaneous	110-127	110-125	3WT9853-1JH00	8600.-
	208-240	220-250	3WT9853-1JK00	8600.-
	380-415	-	3WT9853-1JM00	8600.-
Auxiliary Terminal Block	Fixed circuit breaker		3WT9825-1JC00	6045.-
	Drawout circuit breaker		3WT9827-1JA00	6045.-
Auxiliary Switch Block	2 Change over		3WT9816-1CE00	4625.-
Position Signal Switch for Withdrawable Breaker	3NO+3NC, 2NO+2NC, 1NO+1NC		3WT9884-1JC10	18705.-
5 digit operating cycle counter			3WT9864-OCA00	15615.-
Blocking Device for preventing opening of cubicle door in service position: for Withdrawable Breaker			3WT9867-1JC00	14520.-
Blocking Device for preventing opening of cubicle door in ON position: for Fixed Breaker			3WT9867-2JA00	14520.-
Castell Lock Mounting Kit (to prevent unauthorized closing of the circuit breaker)			3WT9863-6JE00	13395.-
Castell Lock			3WX3663-6JEL_#	5715.-
Door Sealing Frame (Also suitable for 3WL ACB)			3WX3686-0JA00	3640.-
External Current Sensor for N-conductor (For 3P ACB with Neutral or E/F Protection)	Size I		3WL9111-0AA21-0AA0	30495.-
	Size II		3WL9111-0AA22-0AA0	37080.-
External Current Sensor for N-conductor with copper connectors (for 3P ACB with Neutral or E/F protection)	Size I		3WL9111-0AA31-0AA0	33470.-
	Size II		3WL9111-0AA32-0AA0	38415.-

# Types of castell locks shall be of type A, B, C, D, AB, AC; \_ to be replaced by the type no.

For fitment of motor/ shunt/ closing coil/ UV release/ addl. auxiliary contacts please order necessary Auxiliary terminal blocks as per circuit diagram.

## Add-on options (Factory fitted)

Description	Unit LP* ₹
MODBUS RTU communication module	POR
Metering function with integrated Voltage tap	
Arc chute cover	
Phase barriers	

## Retrofit solution

Description	Unit LP* ₹
Ready to fit kit for upgrading from our old or other make conventional Air Circuit Breaker to modern SENTRON range of ACBs. <ul style="list-style-type: none"> <li>• Minimum Shut Down Time</li> <li>• No change in the existing panel except door cut out</li> <li>• No change in the existing panel bus-bars</li> <li>• Proven Siemens Design</li> <li>• No over heating</li> <li>• Cost Effective &amp; Quality Solution</li> </ul>	Upon enquiry

For more details write to us at: [ics.india@siemens.com](mailto:ics.india@siemens.com) • Toll Free No: 1800220987/18002090987

POR: Price On Request

Std. Pkg. = 1 unit

\* LP - List Price



# 3WJ air circuit breakers

Powering infrastructures across the globe



Reliable



Safe



Comprehensive



Efficient



Adaptable



Customizable

[www.siemens.co.in](http://www.siemens.co.in)



**SIEMENS**



# 3VA moulded case circuit breakers

Discover the perfect system

[www.siemens.com/3VA](http://www.siemens.com/3VA)

**SIEMENS**

## MCCB: SENTRON 3VA

- Rated current: 16A to 1250A
- 1 pole<sup>^</sup>, 2 pole<sup>^</sup>, 3 pole & 4 pole versions
- Thermal magnetic and Microprocessor based trip unit
- Common Internal accessories for the entire range
- Information on the GO - Unique Knowledge Manager (QR Code) for 24 X 7 Technical Information
- Innovative Accessories viz. Short Circuit Alarm Switch, Illuminated Handle, Shunt Trip Flexible etc



### SENTRON 3VA MCCB, Thermal Magnetic Trip Unit, Fixed Thermal Fixed Magnetic (FTFM), Ics = 100% Icu, 415VAC, 50Hz

Frame Size	Breaking Capacity @ 415VAC, 50Hz	Rated Current In (A)	3 Pole		4 Pole	
			Type	Unit LP* ₹	Type	Unit LP* ₹
3VA10	16kA	16	3VA1096-2ED32-0AA0	10535.-	3VA1096-2ED42-0AA0	13655.-
		20	3VA1020-2ED32-0AA0	10535.-	3VA1020-2ED42-0AA0	13655.-
		25	3VA1025-2ED32-0AA0	10535.-	3VA1025-2ED42-0AA0	13655.-
		32	3VA1032-2ED32-0AA0	10535.-	3VA1032-2ED42-0AA0	13655.-
		40	3VA1040-2ED32-0AA0	10535.-	3VA1040-2ED42-0AA0	13655.-
		50	3VA1050-2ED32-0AA0	10535.-	3VA1050-2ED42-0AA0	13655.-
		63	3VA1063-2ED32-0AA0	10535.-	3VA1063-2ED42-0AA0	13655.-
		80	3VA1080-2ED32-0AA0	11525.-	3VA1080-2ED42-0AA0	14965.-
		100	3VA1010-2ED32-0AA0	13340.-	3VA1010-2ED42-0AA0	17370.-
3VA10	25kA	16	3VA1096-3ED32-0AA0	10820.-	3VA1096-3ED42-0AA0	14115.-
		20	3VA1020-3ED32-0AA0	10820.-	3VA1020-3ED42-0AA0	14115.-
		25	3VA1025-3ED32-0AA0	10820.-	3VA1025-3ED42-0AA0	14115.-
		32	3VA1032-3ED32-0AA0	10820.-	3VA1032-3ED42-0AA0	14115.-
		40	3VA1040-3ED32-0AA0	10820.-	3VA1040-3ED42-0AA0	14115.-
		50	3VA1050-3ED32-0AA0	10820.-	3VA1050-3ED42-0AA0	14115.-
		63	3VA1063-3ED32-0AA0	10820.-	3VA1063-3ED42-0AA0	14115.-
		80	3VA1080-3ED32-0AA0	11765.-	3VA1080-3ED42-0AA0	15310.-
		100	3VA1010-3ED32-0AA0	13870.-	3VA1010-3ED42-0AA0	17725.-
3VA11		125	3VA1112-3ED32-0AA0	23385.-	3VA1112-3ED42-0AA0	29800.-
		160	3VA1116-3ED32-0AA0	26705.-	3VA1116-3ED42-0AA0	34750.-
3VA10	36kA	16	3VA1096-4ED32-0AA0	11420.-	3VA1196-4GD42-0AA0	15800.-
		20	3VA1020-4ED32-0AA0	11420.-	3VA1120-4GD42-0AA0	15800.-
		25	3VA1025-4ED32-0AA0	11420.-	3VA1125-4GD42-0AA0	15800.-
		32	3VA1032-4ED32-0AA0	11420.-	3VA1132-4GD42-0AA0	15800.-
		40	3VA1040-4ED32-0AA0	11420.-	3VA1140-4GD42-0AA0	15800.-
		50	3VA1050-4ED32-0AA0	11420.-	3VA1150-4GD42-0AA0	15800.-
		63	3VA1063-4ED32-0AA0	11420.-	3VA1163-4GD42-0AA0	15800.-
		80	3VA1080-4ED32-0AA0	11980.-	3VA1180-4GD42-0AA0	17325.-
		100	3VA1010-4ED32-0AA0	14425.-	3VA1110-4GD42-0AA0	20015.-
3VA11		125	3VA1112-4ED32-0AA0	24920.-	3VA1112-4GD42-0AA0	32395.-
		160	3VA1116-4ED32-0AA0	29055.-	3VA1116-4GD42-0AA0	37780.-
3VA11	55kA	16	3VA1196-5ED32-0AA0	13380.-	3VA1196-5GD42-0AA0	17370.-
		20	3VA1120-5ED32-0AA0	13380.-	3VA1120-5GD42-0AA0	17370.-
		25	3VA1125-5ED32-0AA0	13380.-	3VA1125-5GD42-0AA0	17370.-
		32	3VA1132-5ED32-0AA0	13380.-	3VA1132-5GD42-0AA0	17370.-
		40	3VA1140-5ED32-0AA0	13380.-	3VA1140-5GD42-0AA0	17370.-
		50	3VA1150-5ED32-0AA0	13380.-	3VA1150-5GD42-0AA0	17370.-
		63	3VA1163-5ED32-0AA0	13640.-	3VA1163-5GD42-0AA0	17370.-
		80	3VA1180-5ED32-0AA0	14680.-	3VA1180-5GD42-0AA0	19075.-
		100	3VA1110-5ED32-0AA0	16995.-	3VA1110-5GD42-0AA0	22045.-
		125	3VA1112-5ED32-0AA0	27385.-	3VA1112-5GD42-0AA0	35590.-
		160	3VA1116-5ED32-0AA0	31935.-	3VA1116-5GD42-0AA0	41555.-

<sup>^</sup> 3VA1 TMTU up to 160A

Std. Pkg. = 1 unit \* LP - List Price

SENTRON 3VA MCCB, Thermal Magnetic Trip Unit, Adj. Thermal Fixed Magnetic (ATFM), Ics = 100% Icu, 415VAC, 50Hz

Frame Size	Breaking Capacity @ 415VAC, 50Hz	Rated Current In (A)	3 Pole		4 Pole	
			Type	Unit LP* ₹	Type	Unit LP* ₹
3VA11	25kA	16	3VA1196-3EE32-0AA0	13735.-	3VA1196-3GE42-0AA0	19670.-
		20	3VA1120-3EE32-0AA0	13735.-	3VA1120-3GE42-0AA0	19670.-
		25	3VA1125-3EE32-0AA0	13735.-	3VA1125-3GE42-0AA0	19670.-
		32	3VA1132-3EE32-0AA0	13735.-	3VA1132-3GE42-0AA0	19670.-
		40	3VA1140-3EE32-0AA0	13735.-	3VA1140-3GE42-0AA0	19670.-
		50	3VA1150-3EE32-0AA0	13735.-	3VA1150-3GE42-0AA0	19670.-
		63	3VA1163-3EE32-0AA0	13735.-	3VA1163-3GE42-0AA0	19670.-
		80	3VA1180-3EE32-0AA0	13735.-	3VA1180-3GE42-0AA0	19670.-
		100	3VA1110-3EE32-0AA0	14680.-	3VA1110-3GE42-0AA0	19670.-
		125	3VA1112-3EE32-0AA0	24920.-	3VA1112-3GE42-0AA0	30685.-
3VA11	36kA	160	3VA1116-3EE32-0AA0	27490.-	3VA1116-3GE42-0AA0	35645.-
		16	3VA1196-4EE32-0AA0	16955.-	3VA1196-4GE42-0AA0	22195.-
		20	3VA1120-4EE32-0AA0	16955.-	3VA1120-4GE42-0AA0	22195.-
		25	3VA1125-4EE32-0AA0	16955.-	3VA1125-4GE42-0AA0	22195.-
		32	3VA1132-4EE32-0AA0	16955.-	3VA1132-4GE42-0AA0	22195.-
		40	3VA1140-4EE32-0AA0	16955.-	3VA1140-4GE42-0AA0	22195.-
		50	3VA1150-4EE32-0AA0	16955.-	3VA1150-4GE42-0AA0	22195.-
		63	3VA1163-4EE32-0AA0	16955.-	3VA1163-4GE42-0AA0	22195.-
		80	3VA1180-4EE32-0AA0	16955.-	3VA1180-4GE42-0AA0	22195.-
		100	3VA1110-4EE32-0AA0	16955.-	3VA1110-4GE42-0AA0	22195.-
3VA12		125	3VA1112-4EE32-0AA0	26090.-	3VA1112-4GE42-0AA0	33240.-
		160	3VA1116-4EE32-0AA0	29860.-	3VA1116-4GE42-0AA0	38755.-
3VA13		200	3VA1220-4EE32-0AA0	37670.-	3VA1220-4GE42-0AA0	46415.-
		250	3VA1225-4EE32-0AA0	39935.-	3VA1225-4GE42-0AA0	50140.-
3VA14		320	3VA1332-4EE32-0AA0	53550.-	3VA1332-4GE42-0AA0	69330.-
		400	3VA1340-4EE32-0AA0	53550.-	3VA1340-4GE42-0AA0	69330.-
3VA14		500	3VA1450-4EE32-0AA0	69115.-	3VA1450-4GE42-0AA0	89535.-
		630	3VA1463-4EE32-0AA0	69115.-	3VA1463-4GE42-0AA0	89535.-
3VA11	55kA	16	3VA1196-5EE32-0AA0	19320.-	3VA1196-5GE42-0AA0	24420.-
		20	3VA1120-5EE32-0AA0	19320.-	3VA1120-5GE42-0AA0	24420.-
		25	3VA1125-5EE32-0AA0	19320.-	3VA1125-5GE42-0AA0	24420.-
		32	3VA1132-5EE32-0AA0	19320.-	3VA1132-5GE42-0AA0	24420.-
		40	3VA1140-5EE32-0AA0	19320.-	3VA1140-5GE42-0AA0	24420.-
		50	3VA1150-5EE32-0AA0	19320.-	3VA1150-5GE42-0AA0	24420.-
		63	3VA1163-5EE32-0AA0	19320.-	3VA1163-5GE42-0AA0	24420.-
		80	3VA1180-5EE32-0AA0	19320.-	3VA1180-5GE42-0AA0	24420.-
		100	3VA1110-5EE32-0AA0	19320.-	3VA1110-5GE42-0AA0	24420.-
		125	3VA1112-5EE32-0AA0	30345.-	3VA1112-5GE42-0AA0	36445.-
3VA12		160	3VA1116-5EE32-0AA0	32825.-	3VA1116-5GE42-0AA0	42365.-
		200	3VA1220-5EE32-0AA0	39225.-	3VA1220-5GE42-0AA0	47910.-
3VA13		250	3VA1225-5EE32-0AA0	41590.-	3VA1225-5GE42-0AA0	52690.-
		320	3VA1332-5EE32-0AA0	61060.-	3VA1332-5GE42-0AA0	76495.-
3VA14		400	3VA1340-5EE32-0AA0	61060.-	3VA1340-5GE42-0AA0	76495.-
		500	3VA1450-5EE32-0AA0	78975.-	3VA1450-5GE42-0AA0	98660.-
3VA14		630	3VA1463-5EE32-0AA0	78975.-	3VA1463-5GE42-0AA0	98660.-
		800#	3VA1580-5EF32-0AA0	117990.-	3VA1580-5GF42-0AA0	152905.-
3VA15		1000#	3VA1510-5EF32-0AA0	164835.-	3VA1510-5GF42-0AA0	213895.-
		16	3VA1196-6EE32-0AA0	26435.-	3VA1196-6GE42-0AA0	33230.-
3VA11	70kA	20	3VA1120-6EE32-0AA0	26435.-	3VA1120-6GE42-0AA0	33230.-
		25	3VA1125-6EE32-0AA0	26435.-	3VA1125-6GE42-0AA0	33230.-
		32	3VA1132-6EE32-0AA0	26435.-	3VA1132-6GE42-0AA0	33230.-
		40	3VA1140-6EE32-0AA0	26435.-	3VA1140-6GE42-0AA0	33230.-
		50	3VA1150-6EE32-0AA0	26435.-	3VA1150-6GE42-0AA0	33230.-
		63	3VA1163-6EE32-0AA0	26435.-	3VA1163-6GE42-0AA0	33230.-
		80	3VA1180-6EE32-0AA0	26435.-	3VA1180-6GE42-0AA0	33230.-
		100	3VA1110-6EE32-0AA0	26435.-	3VA1110-6GE42-0AA0	33230.-
		125	3VA1112-6EE32-0AA0	49150.-	3VA1112-6GE42-0AA0	52705.-
		160	3VA1116-6EE32-0AA0	49150.-	3VA1116-6GE42-0AA0	52705.-
3VA12		200	3VA1220-6EE32-0AA0	52900.-	3VA1220-6GE42-0AA0	68070.-
		250	3VA1225-6EE32-0AA0	59285.-	3VA1225-6GE42-0AA0	68070.-
3VA13		320	3VA1332-6EE32-0AA0	66930.-	3VA1332-6GE42-0AA0	86525.-
		400	3VA1340-6EE32-0AA0	66930.-	3VA1340-6GE42-0AA0	86525.-
3VA14		500	3VA1450-6EE32-0AA0	95140.-	3VA1450-6GE42-0AA0	123350.-
		630	3VA1463-6EE32-0AA0	95140.-	3VA1463-6GE42-0AA0	123350.-
3VA15		800#	3VA1580-6EF32-0AA0	129930.-	3VA1580-6GF42-0AA0	168375.-
		1000#	3VA1510-6EF32-0AA0	181185.-	3VA1510-6GF42-0AA0	235540.-

Std. Pkg. = 1 unit # - Adjustable Thermal, Adjustable Magnetic \* LP - List Price



SENTRON 3VA MCCB, Thermal Magnetic Trip Unit, Adj. Thermal Adj. Magnetic (ATAM), Ics = 100% Icu, 415VAC, 50Hz

Frame Size	Breaking Capacity @ 415VAC, 50Hz	Rated Current In (A)	3 Pole		4 Pole	
			Type	Unit LP* ₹	Type	Unit LP* ₹
3VA12	36kA	250	3VA1225-4EF32-0AA0	POR	3VA1225-4GF42-0AA0	POR
3VA13		320	3VA1332-4EF32-0AA0		3VA1332-4GF42-0AA0	
3VA14		400	3VA1340-4EF32-0AA0		3VA1340-4GF42-0AA0	
		500	3VA1450-4EF32-0AA0		3VA1450-4GF42-0AA0	
3VA12	55kA	630	3VA1463-4EF32-0AA0		3VA1463-4GF42-0AA0	
3VA13		250	3VA1225-5EF32-0AA0		3VA1225-5GF42-0AA0	
		320	3VA1332-5EF32-0AA0		3VA1332-5GF42-0AA0	
3VA14		400	3VA1340-5EF32-0AA0		3VA1340-5GF42-0AA0	
3VA14	500	3VA1450-5EF32-0AA0	3VA1450-5GF42-0AA0			
	630	3VA1463-5EF32-0AA0	3VA1463-5GF42-0AA0			
3VA12	70kA	250	3VA1225-6EF32-0AA0		3VA1225-6GF42-0AA0	
3VA13		320	3VA1332-6EF32-0AA0		3VA1332-6GF42-0AA0	
		400	3VA1340-6EF32-0AA0	3VA1340-6GF42-0AA0		
3VA14		500	3VA1450-6EF32-0AA0	3VA1450-6GF42-0AA0		
3VA14	630	3VA1463-6EF32-0AA0	3VA1463-6GF42-0AA0			

For lower ratings, please contact your nearest Siemens Sales Office

SENTRON 3VA MCCB for Motor Starter Protection (Adjustable Magnetic trip unit, 3pole)

Frame Size	Rated Current In (A)	Breaking Capacity (55kA, 415V, 50Hz)		Breaking Capacity (70kA, 415V, 50Hz)	
		Type	Unit LP* ₹	Type	Unit LP* ₹
3VA11	1	3VA1181-5MG32-0AA0*	17765.-	3VA1181-6MG32-0AA0*	21820.-
	2	3VA1102-5MG32-0AA0*	17765.-	3VA1102-6MG32-0AA0*	21820.-
	4	3VA1104-5MG32-0AA0*	17765.-	3VA1104-6MG32-0AA0*	21820.-
	8	3VA1108-5MG32-0AA0*	17765.-	3VA1108-6MG32-0AA0*	21820.-
	12.5	3VA1192-5MG32-0AA0*	17765.-	3VA1192-6MG32-0AA0*	21820.-
	20	3VA1120-5MH32-0AA0	17765.-	3VA1120-6MH32-0AA0	21820.-
	32	3VA1132-5MH32-0AA0	21225.-	3VA1132-6MH32-0AA0	22870.-
	40	3VA1140-5MH32-0AA0	21225.-	3VA1140-6MH32-0AA0	22870.-
	50	3VA1150-5MH32-0AA0	21225.-	3VA1150-6MH32-0AA0	22870.-
	63	3VA1163-5MH32-0AA0	21225.-	3VA1163-6MH32-0AA0	22870.-
	80	3VA1180-5MH32-0AA0	21225.-	3VA1180-6MH32-0AA0	22870.-
	100	3VA1110-5MH32-0AA0	21225.-	3VA1110-6MH32-0AA0	22870.-
	125	3VA1112-5MH32-0AA0	30445.-	3VA1112-6MH32-0AA0	32905.-
3VA12	160	3VA1216-5MH32-0AA0	31945.-	3VA1216-6MH32-0AA0	45525.-
	200	3VA1220-5MH32-0AA0	43935.-	3VA1220-6MH32-0AA0	53915.-
3VA13	250	3VA1325-5MH32-0AA0	47940.-	3VA1325-6MH32-0AA0	54565.-
	320	3VA1332-5MH32-0AA0	65785.-	3VA1332-6MH32-0AA0	74965.-
3VA14	400	3VA1440-5MH32-0AA0	75305.-	3VA1440-6MH32-0AA0	78680.-
	500	3VA1450-5MH32-0AA0	86690.-	3VA1450-6MH32-0AA0	98425.-
3VA15	630	3VA1563-5MH32-0AA0	99940.-	3VA1563-6MH32-0AA0	108875.-
	800	3VA1580-5MH32-0AA0	132750.-	3VA1580-6MH32-0AA0	146175.-

POR: Price On Request

Std. Pkg. = 1 unit

\* LP - List Price

& Fixed magnetic trip unit

SETRON 3VA MCCB, Switch Disconnector (without protection)

Frame Size	Breaking Capacity	Rated Current In (A)	3 Pole		4 Pole	
			Type	Unit LP* ₹	Type	Unit LP* ₹
3VA11	NA	63	3VA1163-1AA32-0AA0	14910.-	3VA1163-1AA42-0AA0	22035.-
		100	3VA1110-1AA32-0AA0	14910.-	3VA1110-1AA42-0AA0	22035.-
		125	3VA1112-1AA32-0AA0	30505.-	3VA1112-1AA42-0AA0	40665.-
		160	3VA1116-1AA32-0AA0	30505.-	3VA1116-1AA42-0AA0	40665.-
3VA12	NA	250	3VA1225-1AA32-0AA0	30505.-	3VA1225-1AA42-0AA0	40665.-
3VA13	NA	400	3VA1340-1AA32-0AA0	39345.-	3VA1340-1AA42-0AA0	51155.-

NA - Not Applicable

## Earth fault and Earth leakage protection for SETRON 3VA moulded case circuit breaker

### Earth fault monitoring relay

Description	Type	Unit LP* ₹
Earth fault monitoring relay • Auxiliary voltage: 85-270V AC/DC • Change over contact: 2C/O • Width: 35mm module	7UG0861-1BU20	5805.-
CBCT for EFR: 160 frame Suitable for 3VA1 up to 160A	3P: 7UG09910 4P: 7UG09911	2005.- 2285.-
CBCT for EFR: 250 frame Suitable for 3VA1 250A, 3VA2 up to 250A	3P: 7UG09912 4P: 7UG09913	2420.- 2850.-
CBCT for EFR: 630 frame Suitable for 3VA2 400A/ 630A	3P: 7UG09914 4P: 7UG09915	3565.- 3855.-



### Earth leakage monitoring relay

Description	Type	Unit LP* ₹
Earth leakage relay 1Ph-2W, 3Ph-3W, 3Ph-4W	110VAC: 7UG0841-1CB20 230VAC: 7UG0842-1CD20	5615.- 5670.-
CBCT for ELR	35 mm dia: 7UG0996 70 mm dia: 7UG0997 120 mm dia: 7UG0999 210 mm dia: 7UG0994 310 mm dia: 7UG0995	2045.- 2335.- 3975.- 7650.- 11400.-



Note: Order 1 no of shunt trip release for MCCB separately along with earth fault relay / earth leakage relay



MCCB with O/L & S/C protection

+



Shunt release

+



Ext. Earth fault / Ext. Earth Leakage Relay & CBCT

=



MCCB with O/L, S/C & E/F protection with O/L, S/C & Earth Leakage protection

## Condition monitoring with the 3VA moulded case circuit breaker. As simple as that.

[www.siemens.co.in](http://www.siemens.co.in)

Thanks to optimally scheduled maintenance times, you can prevent equipment and plant failures due to uncoordinated maintenance of individual devices and optimize the health of your entire plant.



Predictive maintenance



Improved organization of personnel and material costs



Optimized energy availability



Reduced time and costs for maintenance



### When time savings go hand in hand with optimized plant reliability



With condition monitoring directly on the 3VA and remotely on the end device, you get reliable information about the health of your system and the remaining service life of your circuit breaker.

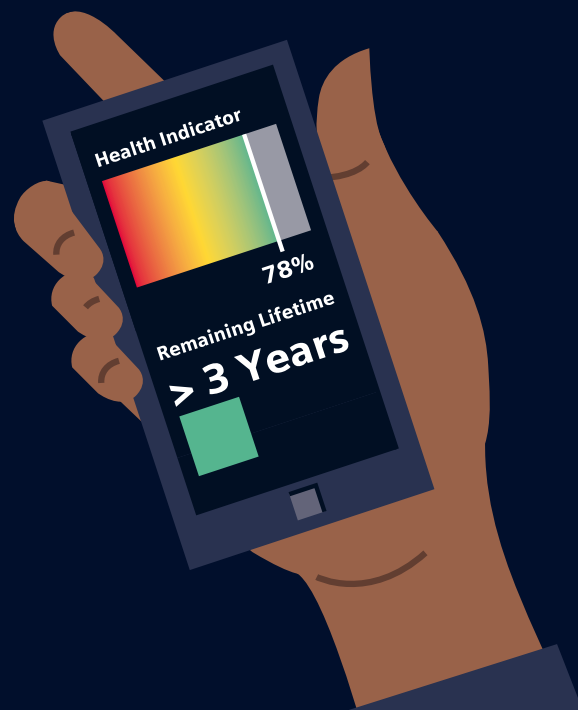
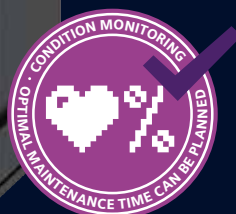

SENTRON 3VA - Flying on the wings of technology

SENTRON 3VA MCCB, Microprocessor Trip Unit, ETU320 LI, Ics = 100% Icu, 415VAC, 50Hz

Frame Size	Breaking Capacity @ 415VAC, 50Hz	Rated Current In (A)	3 Pole		4 Pole	
			Type	Unit LP* ₹	Type	Unit LP* ₹
3VA20	36kA	25	3VA2025-4HL32-0AA0	32340.-	3VA2025-4HL42-0AA0	41690.-
		40	3VA2040-4HL32-0AA0	32340.-	3VA2040-4HL42-0AA0	41690.-
		63	3VA2063-4HL32-0AA0	32340.-	3VA2063-4HL42-0AA0	41690.-
		100	3VA2010-4HL32-0AA0	32340.-	3VA2010-4HL42-0AA0	41690.-
		160	3VA2116-4HL32-0AA0	43720.-	3VA2116-4HL42-0AA0	61020.-
		250	3VA2225-4HL32-0AA0	60000.-	3VA2225-4HL42-0AA0	81355.-
3VA21	55kA	400	3VA2340-4HL32-0AA0	80165.-	3VA2340-4HL42-0AA0	105515.-
3VA22		630	3VA2463-4HL32-0AA0	83345.-	3VA2463-4HL42-0AA0	110440.-
3VA23		25	3VA2025-5HL32-0AA0	41125.-	3VA2025-5HL42-0AA0	56335.-
3VA24		40	3VA2040-5HL32-0AA0	41125.-	3VA2040-5HL42-0AA0	56335.-
3VA20		63	3VA2063-5HL32-0AA0	41125.-	3VA2063-5HL42-0AA0	56335.-
		100	3VA2010-5HL32-0AA0	41125.-	3VA2010-5HL42-0AA0	56335.-
	160	3VA2116-5HL32-0AA0	52125.-	3VA2116-5HL42-0AA0	67500.-	
	250	3VA2225-5HL32-0AA0	68105.-	3VA2225-5HL42-0AA0	89920.-	
	3VA21	400	3VA2340-5HL32-0AA0	86435.-	3VA2340-5HL42-0AA0	113275.-
	3VA22	630	3VA2463-5HL32-0AA0	106175.-	3VA2463-5HL42-0AA0	118575.-
3VA23	85kA	800	3VA2580-5HL32-0AA0	155250.-	3VA2580-5HL42-0AA0	198600.-
3VA24		1000	3VA2510-5HL32-0AA0	205715.-	3VA2510-5HL42-0AA0	274635.-
3VA25		1250	3VA2612-5HL32-0AA0	291660.-	3VA2612-5HL42-0AA0	389460.-
3VA20		25	3VA2025-6HL32-0AA0	53760.-	3VA2025-6HL42-0AA0	66605.-
		40	3VA2040-6HL32-0AA0	53760.-	3VA2040-6HL42-0AA0	66605.-
		63	3VA2063-6HL32-0AA0	53760.-	3VA2063-6HL42-0AA0	66605.-
	100	3VA2010-6HL32-0AA0	53760.-	3VA2010-6HL42-0AA0	66605.-	
	160	3VA2116-6HL32-0AA0	70495.-	3VA2116-6HL42-0AA0	89990.-	
	250	3VA2225-6HL32-0AA0	78290.-	3VA2225-6HL42-0AA0	114015.-	
3VA21	55kA	400	3VA2340-6HL32-0AA0	98245.-	3VA2340-6HL42-0AA0	129005.-
3VA22		630	3VA2463-6HL32-0AA0	117365.-	3VA2463-6HL42-0AA0	156605.-
3VA23		800	3VA2580-6HL32-0AA0	170690.-	3VA2580-6HL42-0AA0	227045.-
3VA24		1000	3VA2510-6HL32-0AA0	235255.-	3VA2510-6HL42-0AA0	314030.-
3VA25		1250	3VA2612-6HL32-0AA0	333325.-	3VA2612-6HL42-0AA0	446170.-
3VA26						

SENTRON 3VA MCCB, Microprocessor Trip Unit, ETU330 LIG, Ics = 100% Icu, 415VAC, 50Hz

Frame Size	Breaking Capacity @ 415VAC, 50Hz	Rated Current In (A)	3 Pole		4 Pole	
			Type	Unit LP* ₹	Type	Unit LP* ₹
3VA20	36kA	25	3VA2025-4HM32-0AA0	44540.-	3VA2025-4HM42-0AA0	54910.-
		40	3VA2040-4HM32-0AA0	44540.-	3VA2040-4HM42-0AA0	54910.-
		63	3VA2063-4HM32-0AA0	44540.-	3VA2063-4HM42-0AA0	54910.-
		100	3VA2010-4HM32-0AA0	44540.-	3VA2010-4HM42-0AA0	54910.-
		160	3VA2116-4HM32-0AA0	56335.-	3VA2116-4HM42-0AA0	70160.-
		250	3VA2225-4HM32-0AA0	71195.-	3VA2225-4HM42-0AA0	89490.-
3VA21	55kA	400	3VA2340-4HM32-0AA0	95750.-	3VA2340-4HM42-0AA0	120775.-
3VA22		630	3VA2463-4HM32-0AA0	105330.-	3VA2463-4HM42-0AA0	132830.-
3VA23		25	3VA2025-5HM32-0AA0	50770.-	3VA2025-5HM42-0AA0	58175.-
3VA24		40	3VA2040-5HM32-0AA0	50770.-	3VA2040-5HM42-0AA0	58175.-
3VA20		63	3VA2063-5HM32-0AA0	50770.-	3VA2063-5HM42-0AA0	58175.-
		100	3VA2010-5HM32-0AA0	51815.-	3VA2010-5HM42-0AA0	60805.-
	160	3VA2116-5HM32-0AA0	69810.-	3VA2116-5HM42-0AA0	83770.-	
	250	3VA2225-5HM32-0AA0	85135.-	3VA2225-5HM42-0AA0	106250.-	
	3VA21	400	3VA2340-5HM32-0AA0	102800.-	3VA2340-5HM42-0AA0	129670.-
	3VA22	630	3VA2463-5HM32-0AA0	113100.-	3VA2463-5HM42-0AA0	142615.-
3VA23	85kA	800	3VA2580-5HM32-0AA0	164125.-	3VA2580-5HM42-0AA0	213370.-
3VA24		1000	3VA2510-5HM32-0AA0	220485.-	3VA2510-5HM42-0AA0	289415.-
3VA20		1250	3VA2612-5HM32-0AA0	308440.-	3VA2612-5HM42-0AA0	407400.-
		25	3VA2025-6HM32-0AA0	63390.-	3VA2025-6HM42-0AA0	77095.-
		40	3VA2040-6HM32-0AA0	63390.-	3VA2040-6HM42-0AA0	77095.-
		63	3VA2063-6HM32-0AA0	63390.-	3VA2063-6HM42-0AA0	77095.-
	100	3VA2010-6HM32-0AA0	63390.-	3VA2010-6HM42-0AA0	77095.-	
	160	3VA2116-6HM32-0AA0	80765.-	3VA2116-6HM42-0AA0	101375.-	
3VA21	55kA	250	3VA2225-6HM32-0AA0	94590.-	3VA2225-6HM42-0AA0	132710.-
3VA22		400	3VA2340-6HM32-0AA0	114610.-	3VA2340-6HM42-0AA0	145370.-
3VA23		630	3VA2463-6HM32-0AA0	126065.-	3VA2463-6HM42-0AA0	159925.-
3VA24		800	3VA2580-6HM32-0AA0	184925.-	3VA2580-6HM42-0AA0	241820.-
3VA20		1000	3VA2510-6HM32-0AA0	249480.-	3VA2510-6HM42-0AA0	328800.-
		1250	3VA2612-6HM32-0AA0	350685.-	3VA2612-6HM42-0AA0	464105.-

Std. Pkg. = 1 unit

\* LP - List Price

## SENTRON 3VA - Accessories

Frame	3VA1 100A/ 160A/ 250A/ 400A/ 630A/ 800A/ 1000A	Unit LP* ₹	3VA2 100A / 160A / 250A 3VA2 400A/630A/800A/1000A/1250A	Unit LP* ₹
Accessory	Type		Type	
Auxiliary switch (AUX)	3VA9988-0AA12 (1 C/O)	2410.-	3VA9988-0AA12 (1 C/O)	2410.-
Alarm switch (TAS)	3VA9988-0AB12 (1 C/O)	3720.-	3VA9988-0AB12 (1 C/O)	3720.-
Short-circuit Alarm switch (SAS) for 3VA1 Only	3VA9988-0AB32 (for 3VA10/ 11 100A/ 160A) 3VA9988-0AB34 (for 3VA12/ 13/ 14 250A/ 400A/ 630A)	1985.- 1985.-	-	-
Electrical alarm switches (EAS) for 3VA2 Only	-	-	3VA9988-0AB22	1985.-
Under voltage release (UVR)				
120-127 V AC 50/60 Hz 208-230 V AC 50/60 Hz 380-400 V AC 50/60 Hz	3VA9908-0BB24 3VA9908-0BB25 3VA9908-0BB26	5695.-	3VA9908-0BB24 3VA9908-0BB25 3VA9908-0BB26	5695.-
Shunt release flexible (STF)				
110-127 V AC 50/60 Hz 208-277 V AC 50/60 Hz 380-500 V AC 50/60 Hz	3VA9988-0BA22 3VA9988-0BA23 3VA9988-0BA24	4290.-	3VA9988-0BA22 3VA9988-0BA23 3VA9988-0BA24	4290.-
Shunt release left (STL)				
110-127 V AC 50/60 Hz 208-277 V AC 50/60 Hz 380-500 V AC 50/60 Hz	3VA9988-0BL32 3VA9988-0BL33 3VA9988-0BL20	4290.-	3VA9988-0BL32 3VA9988-0BL33 3VA9988-0BL20	4290.-
Extended Door Mounted Rotary Operator (including 8UC handle)	3VA9157-0FK51 (for 3VA10/ 11 100A/160A) 3VA9257-0FK51 (for 3VA12 250A) 3VA9467-0FK51 (for 3VA13/ 14 400/ 630A)	2945.- 3100.- 4855.-	3VA9267-0FK51 (for 3VA20/ 21/ 22 100A/ 160A/ 250A) 3VA9467-0FK51 (for 3VA23/ 24 400A/ 630A)	3100.- 4855.-
Extended Door Mounted Rotary Operator ^	3VA9687-0FK21 (for 3VA15 800/ 1000A)	12305.-	3VA9687-0FK21 (for 3VA25/26 800A/1000A/1250A)	12305.-
Illuminated - Door mounted rotary operator 24V DC	3VA9157-0FK23 (for 3VA10/ 11 100A/160A) 3VA9257-0FK23 (for 3VA12 250A) 3VA9467-0FK23 (for 3VA13/ 14 400A/ 630A) 3VA9687-0FK23 (for 3VA15 800A/1000A)	7345.- 8075.- 10265.- 13510.-	3VA9267-0FK23 (for 3VA20/ 21/ 22 100A/ 160A/ 250A) 3VA9467-0FK23 (for 3VA23/ 24 400A/ 630A) 3VA9687-0FK23 (for 3VA25/26 800A/1000A/1250A)	8075.- 10265.- 13510.-
Castell interlock kit* (for breakers with 8UC Handles) (To interlock two or more circuit breakers)	8UC607-01YQ.. (for 3VA10/ 11/ 12/ 13/ 14)	5925.-	8UC607-01YQ.. (for 3VA20/ 21/ 22/ 23/ 24)	5925.-
Sliding Bar Interlock (for same size breakers with Toggle Lever)	3VA9158-0VF30 (for 3VA10/ 11 100A/160A) 3VA9258-0VF30 (for 3VA12 250A) 3VA9368-0VF30 (for 3VA13/ 14 400A/ 630A)	7345.- 7625.- 8610.-	3VA9168-0VF30 (for 3VA20/ 21/ 22 100A/ 160A/ 250A) 3VA9368-0VF30 (for 3VA23/ 24 400A/ 630A)	8075.- 8610.-
Locking device for breaker with Toggle lever	3VA9088-0LB10 (3VA10/ 11/ 12 100A/ 160A/ 250A) 3VA9388-0LB10 (for 3VA13/ 14 400A/ 630A) 3VA9588-0LB10 (3VA15 800/ 1000A)	2245.- 2955.- 6375.-	3VA9388-0LB10 (for 3VA20/ 21/ 22/ 23/ 24 100A/ 160A/ 250A/ 400A/ 630A) 3VA9588-0LB10 (3VA25/26 800/ 1000/ 1250A)	2955.- 6375.-
Motorised drive - (Motorised operator - MO) 110-230V AC/ 110-250VDC	3VA9157-0HA20 (for 3VA11 160A) 3VA9257-0HA20 (for 3VA12 250A) 3VA9467-0HA20 (for 3VA13/ 14 400A/ 630A)	24650.- 32260.- 38090.-	3VA9267-0HA20 (for 3VA20/ 21/ 22 100A/ 160A/ 250A) 3VA9467-0HA20 (for 3VA23/ 24 400A/ 630A)	32260.- 38090.-
Spreader links - Broadened (with phase barriers)	3VA9153-0QC50 (for 3pole, 3VA10/ 11 100A/ 160A) 3VA9154-0QC50 (for 4pole, 3VA10/ 11 100A/ 160A) 3VA9253-0QC50 (for 3pole, 3VA12 250A) 3VA9254-0QC50 (for 4pole, 3VA12 250A) 3VA9483-0QC50 (for 3pole 3VA13/ 14 400A/ 630A) 3VA9484-0QC50 (for 4pole 3VA13/ 14 400A/ 630A)	1215.- 1555.- 1515.- 2015.- 2035.- 2635.-	3VA9263-0QC50 (for 3pole, 3VA20/ 21/ 22 100A/ 160A/ 250A) 3VA9264-0QC50 (for 4pole, 3VA20/ 21/ 22 100A/ 160A/ 250A) 3VA9483-0QC50 (for 3pole, 3VA23/ 24 400A/ 630A) 3VA9484-0QC50 (for 4pole, 3VA23/ 24 400A/ 630A)	1640.- 2140.- 2035.- 2635.-
Busbar extensions (with phase barriers)	3VA9603-0QB00 (for 3pole, 3VA15 800A/ 1000A) 3VA9604-0QB00 (for 4pole, 3VA15 800A/ 1000A)	6765.- 9035.-	3VA9603-0QB00 (for 3pole, 3VA25 800A/ 1000A) 3VA9604-0QB00 (for 4pole, 3VA25 800A/ 1000A)	6765.- 9035.-
Rear Terminals - Flat 1 set = 2 short + 1 Long (3pole) / 2 short + 2 Long (4pole)	3VA9113-0QE00 (for 3pole, 3VA10/ 11 100A/ 160A) 3VA9114-0QE00 (for 4pole, 3VA10/ 11 100A/ 160A) 3VA9213-0QE00 (for 3pole, 3VA12 250A) 3VA9214-0QE00 (for 4pole, 3VA12 250A) 3VA9403-0QE00 (for 3pole, 3VA13/ 14 400A/ 630A) 3VA9404-0QE00 (for 4pole, 3VA13/ 14 400A/ 630A)	2520.- 3405.- 3220.- 4310.- 5225.- 6970.-	3VA9203-0QE00 (for 3pole, 3VA20/ 21/ 22 100A/ 160A/ 250A) 3VA9204-0QE00 (for 4pole, 3VA20/ 21/ 22 100A/ 160A/ 250A) 3VA9403-0QE00 (for 3pole, 3VA23/ 24 400A/ 630A) 3VA9404-0QE00 (for 4pole, 3VA23/ 24 400A/ 630A)	3220.- 4310.- 5225.- 6970.-
Phase Barriers (1 set = 2 phase barriers)	3VA9152-0WA00 (for 3VA10/ 11 100A/ 160A) 3VA9252-0WA00 (for 3VA12 250A) 3VA9482-0WA00 (for 3VA13/ 14 400A/ 630A) 3VA9602-0WA00 (for 3VA15 800A/ 1000A)	480.- 480.- 1130.- 1135.-	3VA9262-0WA00 (for 3VA20/ 21/ 22 100A/ 160A/ 250A) 3VA9482-0WA00 (for 3VA23/ 24 400A/ 630A) 3VA9602-0WA00 (for 3VA25/26 800A/1000A/1250A)	480.- 1130.- 1135.-
3VA Adapter for mounting on 8US 60mm busbar system	8US1213-4AU01 (for 3pole, 3VA10/ 11) 8US1213-4AP03 (for 3-pole, 3VA12) 8US1213-4AH04 (for 3pole, 3VA13/ 14)	POR	8US1213-4AP03 (for 3VA20/ 21/ 22) 8US1213-4AH04 (for 3VA23/ 24)	POR

**Notes:**

# The 11th and 12th place of the type reference will indicate the alphabet type of lock & key. Combinations available are A, B, C, D, A-, -B, -C, AB, AC. 11th place will be A, B, C, D for castell lock type A, B, C, D respectively. 11th and 12 place will be A0, 0B, 0C, AB, AC for castell lock type A-, -B, -C, AB, AC respectively

For higher breaking capacities (110kA and 150kA) and other special application MCCB, please contact your nearest Siemens Sales Office.

For side mounted handles please contact your nearest Siemens Sales Office.

\* 1 set contains rotary mechanism, coupler, shaft and 8UC Front drive.

Spreader link 1 set = 3 nos. links and 2 nos. phase barriers in case of 3 pole; and 4 nos. links and 3 nos. phase barriers in case of 4 pole.

1) Door mounted rotary handles are not available for 1pole/ 2pole 3VA1 MCCBs

^ 3VA2 800A/1000A/1250A, extended rotary operator imported version (with 8UD handles)

Standard packing of 3VA26 1250A MCCB includes spreaders & phase barriers

Std. Pkg. = 1 unit

\* LP - List Price

POR: Price On Request



## SETRON 3VA27 moulded case circuit breakers

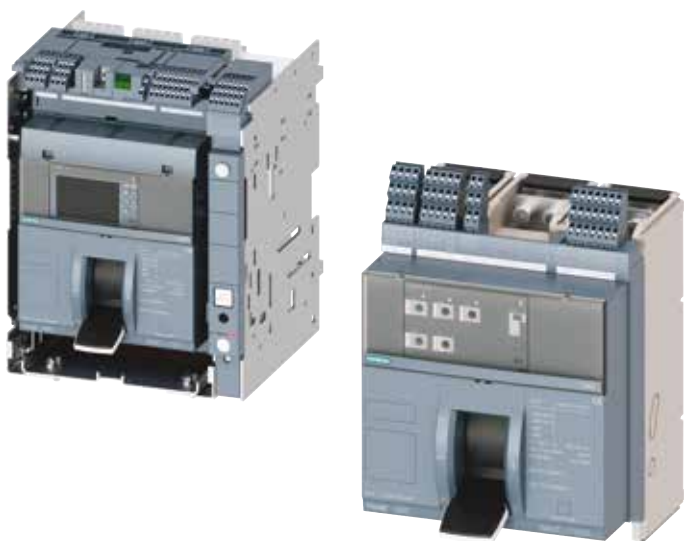

- Line, motor, starter protection and non-automatic circuit breaker
- Rated currents 800A to 1600A (3pole/ 4pole)
- Fixed & Draw-out variants
- Toggle lever or Stored-energy Operator (factory fitted)
- Interchangeable ETU LI/ LSI/ LSIg protection
- Short-circuit breaking capacity 55kA to 110 kA @ 415 V AC
- Communication via Modbus TCP, Modbus RTU, PROFIBUS & PROFINET
- Metering function according to IEC 61557-12

### SETRON 3VA MCCB, Microprocessor Trip Unit, ETU320 LI, Ics = 100% Icu, 415VAC, 50Hz <sup>§</sup> (Fixed mounted)

Frame Size	Breaking Capacity @ 415VAC, 50Hz	Rated Current In (A)	3 Pole		4 Pole	
			Type	Unit LP* ₹	Type	Unit LP* ₹
3VA27	55kA	1250	3VA2712-5AB03-0AA0	311420.-	3VA2712-5AB13-0AA0	418860.-
		1600	3VA2716-5AB03-0AA0	431000.-	3VA2716-5AB13-0AA0	580005.-
	85kA	1250	3VA2712-6AB03-0AA0	342115.-	3VA2712-6AB13-0AA0	460415.-
		1600	3VA2716-6AB03-0AA0	473205.-	3VA2716-6AB13-0AA0	637550.-

### SETRON 3VA MCCB, Microprocessor Trip Unit, ETU360 LSIg, Ics = 100% Icu, 415VAC, 50Hz <sup>§</sup> (Fixed mounted)

Frame Size	Breaking Capacity @ 415VAC, 50Hz	Rated Current In (A)	3 Pole		4 Pole	
			Type	Unit LP* ₹	Type	Unit LP* ₹
3VA27	55kA	1250	3VA2712-5AD03-0AA0	337000.-	3VA2712-5AD13-0AA0	443790.-
		1600	3VA2716-5AD03-0AA0	455940.-	3VA2716-5AD13-0AA0	604935.-
	85kA	1250	3VA2712-6AD03-0AA0	367050.-	3VA2712-6AD13-0AA0	485995.-
		1600	3VA2716-6AD03-0AA0	498150.-	3VA2716-6AD13-0AA0	665045.-

## Accessories for 3VA27

	Description	Type	Unit LP* ₹	Std. pkg. (nos.)
	Auxiliary switch (AUX)	3VW9011-0AG01	5555.-	1
	Alarm switch (TAS)	3VW9011-0AH14	2745.-	1
	Shunt release (ST)			
	110-120 V AC 50/60 HZ 220-240 V AC 50/60 HZ	3VW9011-0AD05 3VW9011-0AD07	12780.-	1
	Under voltage release (UVR)			
	110-120 V AC 50/60 Hz 220-240 V AC 50/60 Hz 415-440 V AC 50/60 Hz	3VW9011-0AE05 3VW9011-0AE07 3VW9011-0AE18	13840.-	1
	Extended Door Mounted Rotary Operator <sup>^</sup> (Standard - Gray)	3VW9727-0FK21	12305.-	1

<sup>§</sup> Toggle lever variants <sup>^</sup>3VA27 extended door mounted rotary operator (imported) with 8UD handles

All MCCBs are suitable for Front Terminals connection only.

Accessories can also be offered in factory fitted options

Please contact your nearest Siemens Sales Office for more Auxiliary combinations & choice of accessories

Std. Pkg. = 1 unit \* LP - List Price



# SIMARIS software tools

## SIMARIS suite: Easy access to SIMARIS planning tools

Integrated and Safe planning of complete power  
distribution system

### SIMARIS design

Power distribution network planning

- From medium-voltage in-feed down to final distribution
- Based on calculations as per IS/ IEC standards
- With automatic selection of appropriate switchgear & components

### SIMARIS curves

Visualization & evaluation of:

- Tripping characteristics
- Cut-off current characteristics
- Let-through energy curves

\*Download FREE version from [www.siemens.com/simaris](http://www.siemens.com/simaris)

[www.siemens.com/simaris](http://www.siemens.com/simaris)

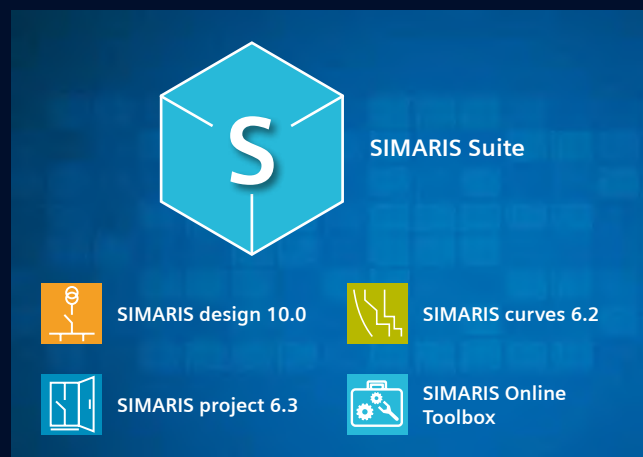

# SIEMENS



# 3VM moulded case circuit breaker

Efficient. Powerful.

[www.siemens.co.in](http://www.siemens.co.in)

**SIEMENS**



## MCCB: SENTRON 3VM

- Rated current: 16A to 630A
- 1 pole, 2 pole, 3 pole & 4 pole versions
- Breaking capacity: 16kA to 55kA
- Thermal magnetic trip unit (FTFM, ATFM, AM, FM)
- Switch disconnectors
- Common Internal accessories for the entire range
- Knowledge Manager (QR Code)



### SENTRON 3VM, Thermal Magnetic Trip Unit, Fixed Thermal Fixed Magnetic (FTFM), 415VAC, 50Hz

Frame Size	Breaking Capacity @ 415VAC, 50Hz	Rated Current In (A)	3 Pole Type	Unit MRP <sup>®</sup> ₹	4 Pole Type	Unit MRP <sup>®</sup> ₹
3VM10	16kA	16	3VM1096-2ED32-0AA0	9455.-	3VM1096-2ED42-0AA0	12255.-
		20	3VM1020-2ED32-0AA0	9455.-	3VM1020-2ED42-0AA0	12255.-
		25	3VM1025-2ED32-0AA0	9455.-	3VM1025-2ED42-0AA0	12255.-
		32	3VM1032-2ED32-0AA0	9455.-	3VM1032-2ED42-0AA0	12255.-
		40	3VM1040-2ED32-0AA0	9455.-	3VM1040-2ED42-0AA0	12255.-
		50	3VM1050-2ED32-0AA0	9455.-	3VM1050-2ED42-0AA0	12255.-
		63	3VM1063-2ED32-0AA0	9455.-	3VM1063-2ED42-0AA0	12255.-
		80	3VM1080-2ED32-0AA0	10335.-	3VM1080-2ED42-0AA0	13420.-
		100	3VM1010-2ED32-0AA0	11215.-	3VM1010-2ED42-0AA0	14610.-
3VM10	25kA	16	3VM1096-3ED32-0AA0	9800.-	3VM1096-3ED42-0AA0	12795.-
		20	3VM1020-3ED32-0AA0	9800.-	3VM1020-3ED42-0AA0	12795.-
		25	3VM1025-3ED32-0AA0	9800.-	3VM1025-3ED42-0AA0	12795.-
		32	3VM1032-3ED32-0AA0	9800.-	3VM1032-3ED42-0AA0	12795.-
		40	3VM1040-3ED32-0AA0	9800.-	3VM1040-3ED42-0AA0	12795.-
		50	3VM1050-3ED32-0AA0	9800.-	3VM1050-3ED42-0AA0	12795.-
		63	3VM1063-3ED32-0AA0	9800.-	3VM1063-3ED42-0AA0	12795.-
		80	3VM1080-3ED32-0AA0	10670.-	3VM1080-3ED42-0AA0	13875.-
		100	3VM1010-3ED32-0AA0	11455.-	3VM1010-3ED42-0AA0	14910.-
3VM11		125	3VM1112-3ED32-0AA0	14685.-	3VM1112-3ED42-0AA0	19390.-
		160	3VM1116-3ED32-0AA0	19155.-	3VM1116-3ED42-0AA0	24255.-

Frame Size	Breaking Capacity @ 415VAC, 50Hz	Rated Current In (A)	3 Pole Type	Unit LP* ₹	4 Pole Type	Unit LP* ₹
3VM11	36kA	16	3VM1196-4ED32-0AA0	10340.-	3VM1196-4GD42-0AA0	14315.-
		20	3VM1120-4ED32-0AA0	10340.-	3VM1120-4GD42-0AA0	14315.-
		25	3VM1125-4ED32-0AA0	10340.-	3VM1125-4GD42-0AA0	14315.-
		32	3VM1132-4ED32-0AA0	10340.-	3VM1132-4GD42-0AA0	14315.-
		40	3VM1140-4ED32-0AA0	10340.-	3VM1140-4GD42-0AA0	14315.-
		50	3VM1150-4ED32-0AA0	10340.-	3VM1150-4GD42-0AA0	14315.-
		63	3VM1163-4ED32-0AA0	10340.-	3VM1163-4GD42-0AA0	14315.-
		80	3VM1180-4ED32-0AA0	10855.-	3VM1180-4GD42-0AA0	15695.-
		100	3VM1110-4ED32-0AA0	12600.-	3VM1110-4GD42-0AA0	18140.-
		125	3VM1112-4ED32-0AA0	22120.-	3VM1112-4GD42-0AA0	28755.-
		160	3VM1116-4ED32-0AA0	24435.-	3VM1116-4GD42-0AA0	31775.-
		3VM12		200	3VM1220-4ED32-0AA0	26250.-
		250	3VM1225-4ED32-0AA0	35015.-	3VM1225-4GD42-0AA0	41255.-
3VM13		320	3VM1332-4ED32-0AA0	47500.-	3VM1332-4GD42-0AA0	58735.-
		400	3VM1340-4ED32-0AA0	48750.-	3VM1340-4GD42-0AA0	59990.-
3VM14		500	3VM1450-4ED32-0AA0	53630.-	3VM1450-4GD42-0AA0	64875.-
		630	3VM1463-4ED32-0AA0	53630.-	3VM1463-4GD42-0AA0	64875.-

^ 3VM11 TMTU up to 160A

AM: Adjustable Magnetic

FM: Fixed Magnetic

Std. Pkg. = 1 unit

\* LP - List Price

® MRP - Max. Retail Price

SENTRON 3VM, Thermal Magnetic Trip Unit, Fixed Thermal Fixed Magnetic (FTFM), 415VAC, 50Hz (Contd.)

Frame Size	Breaking Capacity @ 415VAC, 50Hz	Rated Current In (A)	3 Pole Type	Unit LP* ₹	4 Pole Type	Unit LP* ₹
3VM11	55kA	16	3VM1196-5ED32-0AA0	11885.-	3VM1196-5GD42-0AA0	15420.-
		20	3VM1120-5ED32-0AA0	11885.-	3VM1120-5GD42-0AA0	15420.-
		25	3VM1125-5ED32-0AA0	11885.-	3VM1125-5GD42-0AA0	15420.-
		32	3VM1132-5ED32-0AA0	11885.-	3VM1132-5GD42-0AA0	15420.-
		40	3VM1140-5ED32-0AA0	11885.-	3VM1140-5GD42-0AA0	15420.-
		50	3VM1150-5ED32-0AA0	11885.-	3VM1150-5GD42-0AA0	15420.-
		63	3VM1163-5ED32-0AA0	11885.-	3VM1163-5GD42-0AA0	15420.-
		80	3VM1180-5ED32-0AA0	13025.-	3VM1180-5GD42-0AA0	16930.-
		100	3VM1110-5ED32-0AA0	15085.-	3VM1110-5GD42-0AA0	19580.-
		125	3VM1112-5ED32-0AA0	24310.-	3VM1112-5GD42-0AA0	31605.-
		160	3VM1116-5ED32-0AA0	26855.-	3VM1116-5GD42-0AA0	34945.-
3VM12		200	3VM1220-5ED32-0AA0	29050.-	3VM1220-5GD42-0AA0	36810.-
		250	3VM1225-5ED32-0AA0	37815.-	3VM1225-5GD42-0AA0	45580.-
3VM13		320	3VM1332-5ED32-0AA0	51510.-	3VM1332-5GD42-0AA0	61830.-
		400	3VM1340-5ED32-0AA0	52775.-	3VM1340-5GD42-0AA0	63090.-
3VM14		500	3VM1450-5ED32-0AA0	57640.-	3VM1450-5GD42-0AA0	67960.-
		630	3VM1463-5ED32-0AA0	57640.-	3VM1463-5GD42-0AA0	67960.-

## An extensive portfolio of connection components....

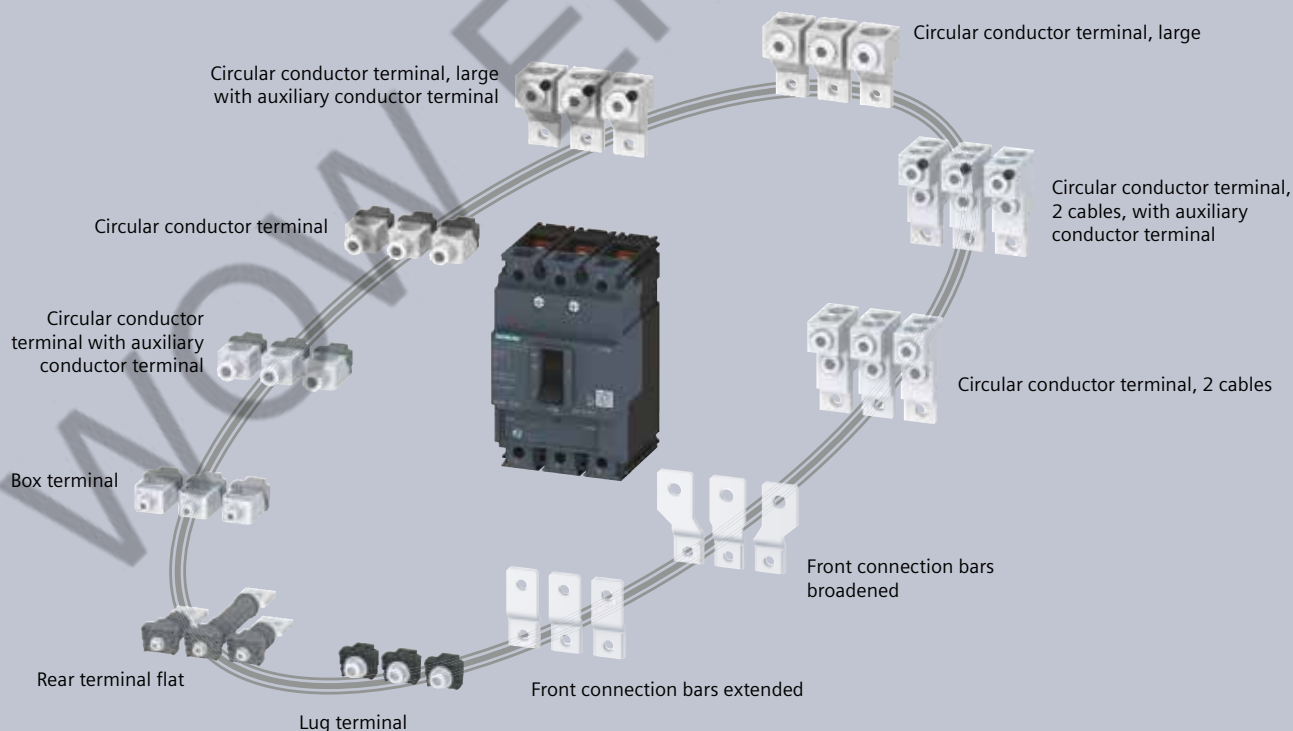

**..to meet ALL installation requirements.**

Std. Pkg. = 1 unit

\* LP - List Price

SENTRON 3VM, Thermal Magnetic Trip Unit, Adj. Thermal Fixed Magnetic (ATFM), 415VAC, 50Hz

Frame Size	Breaking Capacity @ 415VAC, 50Hz	Rated Current In (A)	3 Pole Type	Unit LP* ₹	4 Pole Type	Unit LP* ₹
3VM11	25kA	16	3VM1196-3EE32-0AA0	11640.-	3VM1196-3GE42-0AA0	17545.-
		20	3VM1120-3EE32-0AA0	11640.-	3VM1120-3GE42-0AA0	17545.-
		25	3VM1125-3EE32-0AA0	11640.-	3VM1125-3GE42-0AA0	17545.-
		32	3VM1132-3EE32-0AA0	11640.-	3VM1132-3GE42-0AA0	17545.-
		40	3VM1140-3EE32-0AA0	11640.-	3VM1140-3GE42-0AA0	17545.-
		50	3VM1150-3EE32-0AA0	11640.-	3VM1150-3GE42-0AA0	17545.-
		63	3VM1163-3EE32-0AA0	11640.-	3VM1163-3GE42-0AA0	17545.-
		80	3VM1180-3EE32-0AA0	11640.-	3VM1180-3GE42-0AA0	17545.-
		100	3VM1110-3EE32-0AA0	11640.-	3VM1110-3GE42-0AA0	17545.-
				125	3VM1112-3EE32-0AA0	15025.-
		160	3VM1116-3EE32-0AA0	20670.-	3VM1116-3GE42-0AA0	26310.-
3VM11	36kA	16	3VM1196-4EE32-0AA0	15055.-	3VM1196-4GE42-0AA0	19705.-
		20	3VM1120-4EE32-0AA0	15055.-	3VM1120-4GE42-0AA0	19705.-
		25	3VM1125-4EE32-0AA0	15055.-	3VM1125-4GE42-0AA0	19705.-
		32	3VM1132-4EE32-0AA0	15055.-	3VM1132-4GE42-0AA0	19705.-
		40	3VM1140-4EE32-0AA0	15055.-	3VM1140-4GE42-0AA0	19705.-
		50	3VM1150-4EE32-0AA0	15055.-	3VM1150-4GE42-0AA0	19705.-
		63	3VM1163-4EE32-0AA0	15055.-	3VM1163-4GE42-0AA0	19705.-
		80	3VM1180-4EE32-0AA0	15055.-	3VM1180-4GE42-0AA0	19705.-
		100	3VM1110-4EE32-0AA0	15055.-	3VM1110-4GE42-0AA0	19705.-
				125	3VM1112-4EE32-0AA0	23170.-
		160	3VM1116-4EE32-0AA0	25110.-	3VM1116-4GE42-0AA0	32595.-
3VM12		200	3VM1220-4EE32-0AA0	36315.-	3VM1220-4GE42-0AA0	42380.-
		250	3VM1225-4EE32-0AA0	36315.-	3VM1225-4GE42-0AA0	42380.-
3VM13		320	3VM1332-4EE32-0AA0	48615.-	3VM1332-4GE42-0AA0	59520.-
		400	3VM1340-4EE32-0AA0	49065.-	3VM1340-4GE42-0AA0	59520.-
3VM14		500	3VM1450-4EE32-0AA0	55535.-	3VM1450-4GE42-0AA0	66435.-
		630	3VM1463-4EE32-0AA0	55535.-	3VM1463-4GE42-0AA0	66435.-
3VM11	55kA	16	3VM1196-5EE32-0AA0	17155.-	3VM1196-5GE42-0AA0	21675.-
		20	3VM1120-5EE32-0AA0	17155.-	3VM1120-5GE42-0AA0	21675.-
		25	3VM1125-5EE32-0AA0	17155.-	3VM1125-5GE42-0AA0	21675.-
		32	3VM1132-5EE32-0AA0	17155.-	3VM1132-5GE42-0AA0	21675.-
		40	3VM1140-5EE32-0AA0	17155.-	3VM1140-5GE42-0AA0	21675.-
		50	3VM1150-5EE32-0AA0	17155.-	3VM1150-5GE42-0AA0	21675.-
		63	3VM1163-5EE32-0AA0	17155.-	3VM1163-5GE42-0AA0	21675.-
		80	3VM1180-5EE32-0AA0	17155.-	3VM1180-5GE42-0AA0	21675.-
		100	3VM1110-5EE32-0AA0	17155.-	3VM1110-5GE42-0AA0	21675.-
				125	3VM1112-5EE32-0AA0	26935.-
		160	3VM1116-5EE32-0AA0	27615.-	3VM1116-5GE42-0AA0	35635.-
3VM12		200	3VM1220-5EE32-0AA0	39030.-	3VM1220-5GE42-0AA0	46565.-
		250	3VM1225-5EE32-0AA0	39030.-	3VM1225-5GE42-0AA0	46565.-
3VM13		320	3VM1332-5EE32-0AA0	52510.-	3VM1332-5GE42-0AA0	62520.-
		400	3VM1340-5EE32-0AA0	53000.-	3VM1340-5GE42-0AA0	62520.-
3VM14		500	3VM1450-5EE32-0AA0	59415.-	3VM1450-5GE42-0AA0	69430.-
		630	3VM1463-5EE32-0AA0	59415.-	3VM1463-5GE42-0AA0	69430.-

Circuit Breakers

Std. Pkg. = 1 unit

\* LP - List Price

SETRON 3VM, Motor Starter Protection, 3pole, Adjustable Magnetic (AM) trip unit

Frame Size	Rated Current In (A)	Breaking Capacity (55kA, 415V, 50Hz)	Unit LP* ₹
3VM11	8 <sup>1)</sup>	3VM1108-5MG32-0AA0	14945.-
	12.5 <sup>1)</sup>	3VM1192-5MG32-0AA0	14945.-
	20	3VM1120-5MH32-0AA0	14945.-
	32	3VM1132-5MH32-0AA0	17850.-
	40	3VM1140-5MH32-0AA0	17850.-
	50	3VM1150-5MH32-0AA0	17850.-
	63	3VM1163-5MH32-0AA0	17850.-
	80	3VM1180-5MH32-0AA0	17850.-
	100	3VM1110-5MH32-0AA0	17850.-
	125	3VM1112-5MH32-0AA0	26570.-
3VM12	160	3VM1216-5MH32-0AA0	26570.-
	200	3VM1220-5MH32-0AA0	40310.-
3VM13	250	3VM1325-5MH32-0AA0	40310.-
	320	3VM1332-5MH32-0AA0	57760.-
3VM14	400	3VM1440-5MH32-0AA0	57760.-
	500	3VM1450-5MH32-0AA0	64020.-



SETRON 3VM, Switch Disconnecter (without protection)

Frame Size	Rated Current In (A)	3pole Type	Unit LP* ₹	4pole Type	Unit LP* ₹
3VM11	63	3VM1163-1AA32-0AA0	11150.-	3VM1163-1AA42-0AA0	16475.-
	100	3VM1110-1AA32-0AA0	11150.-	3VM1110-1AA42-0AA0	16475.-
	125	3VM1112-1AA32-0AA0	16265.-	3VM1112-1AA42-0AA0	20475.-
	160	3VM1116-1AA32-0AA0	16265.-	3VM1116-1AA42-0AA0	20475.-
3VM12	250	3VM1225-1AA32-0AA0	27075.-	3VM1225-1AA42-0AA0	36110.-
3VM13	400	3VM1340-1AA32-0AA0	34930.-	3VM1340-1AA42-0AA0	45420.-

<sup>1)</sup> Fixed magnetic

## 3VM Plug in Portfolio

16A-630A, 3P & 4P



3VM MCCB



Plug in kit

### Plug in technology



Easy to handle



Quick Replacement



Safe Installation

Available as complete kit and/or conversion kit. Please contact your nearest Siemens Sales Office for further information.

SENTRON 3VM, Thermal Magnetic Trip Unit, Fixed Thermal Fixed Magnetic (FTFM)

Frame Size	Breaking Capacity	Rated Current In (A)	1 Pole Type	Unit LP* ₹	2 Pole Type	Unit LP* ₹
3VM11	25kA <sup>1)</sup>	16	3VM1196-3ED12-0AA0	4350.-	3VM1196-3ED22-0AA0	7800.-
		20	3VM1120-3ED12-0AA0	4350.-	3VM1120-3ED22-0AA0	7800.-
		25	3VM1125-3ED12-0AA0	4350.-	3VM1125-3ED22-0AA0	7800.-
		32	3VM1132-3ED12-0AA0	4350.-	3VM1132-3ED22-0AA0	7800.-
		40	3VM1140-3ED12-0AA0	4350.-	3VM1140-3ED22-0AA0	7800.-
		50	3VM1150-3ED12-0AA0	4350.-	3VM1150-3ED22-0AA0	7800.-
		63	3VM1163-3ED12-0AA0	4350.-	3VM1163-3ED22-0AA0	7800.-
		80	3VM1180-3ED12-0AA0	4785.-	3VM1180-3ED22-0AA0	8545.-
		100	3VM1110-3ED12-0AA0	5520.-	3VM1110-3ED22-0AA0	10015.-
		125	3VM1112-3ED12-0AA0	8920.-	3VM1112-3ED22-0AA0	16205.-
		160	3VM1116-3ED12-0AA0	10390.-	3VM1116-3ED22-0AA0	18710.-
3VM11	36kA <sup>1)</sup>	16	3VM1196-4ED12-0AA0	4710.-	3VM1196-4ED22-0AA0	8545.-
		20	3VM1120-4ED12-0AA0	4710.-	3VM1120-4ED22-0AA0	8545.-
		25	3VM1125-4ED12-0AA0	4710.-	3VM1125-4ED22-0AA0	8545.-
		32	3VM1132-4ED12-0AA0	4710.-	3VM1132-4ED22-0AA0	8545.-
		40	3VM1140-4ED12-0AA0	4710.-	3VM1140-4ED22-0AA0	8545.-
		50	3VM1150-4ED12-0AA0	4710.-	3VM1150-4ED22-0AA0	8545.-
		63	3VM1163-4ED12-0AA0	4710.-	3VM1163-4ED22-0AA0	8545.-
		80	3VM1180-4ED12-0AA0	5230.-	3VM1180-4ED22-0AA0	9435.-
		100	3VM1110-4ED12-0AA0	5630.-	3VM1110-4ED22-0AA0	10900.-
		125	3VM1112-4ED12-0AA0	9660.-	3VM1112-4ED22-0AA0	17375.-
		160	3VM1116-4ED12-0AA0	11265.-	3VM1116-4ED22-0AA0	20330.-

<sup>1)</sup> 1pole : Icu 25kA/ 36kA @ 240VAC, 2pole : Icu 25kA/ 36kA @ 415VAC

Earth fault protection for SENTRON 3VM moulded case circuit breaker

Description	Type	Unit LP* ₹
Earth fault monitoring relay	7UG0861-1BU20	5805.-
CBCT for EFR: 160 frame Suitable for 3VM10/11	3P	7UG09910
	4P	7UG09911
CBCT for EFR: 250 frame Suitable for 3VM12	3P	7UG09912
	4P	7UG09913
CBCT for EFR: 630 frame Suitable for 3VM13/14	3P	7UG09914
	4P	7UG09915

Earth leakage protection for SENTRON 3VM moulded case circuit breaker

Description	Type	Unit LP* ₹
Earth leakage relay 1Ph-2W, 3Ph-3W, 3Ph-4W	110VAC	7UG0841-1CB20
	230VAC	7UG0842-1CD20
CBCT for ELR	35 mm dia	7UG0996
	70 mm dia	7UG0997
	120 mm dia	7UG0999
	210 mm dia	7UG0994
	310 mm dia	7UG0995

Note: Order 1 no of shunt trip release for MCCB separately along with earth fault relay / earth leakage relay

Std. Pkg. = 1 unit

\* LP - List Price

Internal accessories for SENTRON 3VM10/11/12/13/14 100A-630A

MLFB	Description	Unit LP*₹
<b>Auxiliary Switches and Alarm Switches (1 C/O)</b>		
3VM9988-0AA12	Auxiliary Switch AUX (1 C/O)	1870.-
3VM9988-0AB12	Trip Alarm Switch TAS (1 C/O)	1870.-
<b>Undervoltage releases</b>		
3VM9908-0BB11	UVR 24V DC	4175.-
3VM9908-0BB12	UVR 48V DC	4175.-
3VM9908-0BB23	UVR 110 V AC 50/60HZ	4175.-
3VM9908-0BB25	UVR 208-230 V AC 50/60 HZ	4175.-
3VM9908-0BB26	UVR 380-400 V AC 50/60 HZ	4175.-
<b>Shunt release (Left)</b>		
3VM9908-0BL30	STL 24V AC 50/60Hz / 12-30V DC	3385.-
3VM9908-0BL31	STL 48-60V AC 50/60Hz/ DC	3385.-
3VM9908-0BL32	STL 110-127 V AC 50/60 HZ / DC	3385.-
3VM9908-0BL33	STL 208-277 V AC 50/60 HZ / 220-250 V DC	3385.-
3VM9908-0BL20	STL 380-600 V AC 50/60 HZ	3385.-

External Accessories:

MLFB	Description	Unit LP*₹
<b>Rotary Handles <sup>1)</sup></b>		
3VM9117-0FK51 <sup>®</sup>	Door mounted Rotary Operator with 8UC drive, Standard, 3VM10/ 11	2290.-
3VM9217-0FK51 <sup>®</sup>	Door mounted Rotary Operator with 8UC drive, Standard, 3VM12	2895.-
3VM9417-0FK51 <sup>®</sup>	Door mounted Rotary Operator with 8UC drive, Standard, 3VM13/ 14	3265.-
3VM9117-0EK21	Direct mounted Rotary Operator (Grey), Standard, 3VM10/ 11	2675.-
3VM9217-0EK21	Direct mounted Rotary Operator (Grey), Standard, 3VM12	3515.-
3VM9417-0EK21	Direct mounted Rotary Operator (Grey), Standard, 3VM13/ 14	3875.-
<b>Spreaders (incl. Phase barriers)</b>		
3VM9153-0QC50	Spreader links - Broadened, 3pole, 3VM10/ 11	1215.-
3VM9154-0QC50	Spreader links - Broadened, 4pole, 3VM10/ 11	1555.-
3VM9253-0QC50	Spreader links - Broadened, 3pole, 3VM12	1515.-
3VM9254-0QC50	Spreader links - Broadened, 4pole, 3VM12	2015.-
3VM9483-0QC50	Spreader links - Broadened, 3pole, 3VM13/ 14	2035.-
3VM9484-0QC50	Spreader links - Broadened, 4pole, 3VM13/ 14	2635.-
<b>Extended terminals (incl. Phase barriers)</b>		
3VM9253-0QB50	Extended terminals, 3pole, 3VM12	1020.-
3VM9254-0QB50	Extended terminals, 4pole, 3VM12	1360.-
3VM9483-0QB50	Extended terminals, 3pole, 3VM13/ 14	1375.-
3VM9484-0QB50	Extended terminals, 4pole, 3VM13/ 14	1790.-
<b>Phase barriers</b>		
3VM9152-0WA00	Phase barriers (1set = 2 phase barriers), 3VM10/ 11	785.-
3VM9252-0WA00	Phase barriers (1set = 2 phase barriers), 3VM12	1095.-
3VM9482-0WA00	Phase barriers (1set = 2 phase barriers), 3VM13/ 14	1095.-
<b>Locking device for breaker with Toggle lever</b>		
3VM9188-0LB10	Locking device for: 3VM10/ 11/ 12	2085.-
3VM9388-0LB10	Locking device for: 3VM13/ 14	2740.-
<b>Interlocking (for MCCBs with 8UC handles)</b>		
8UC60701YQ.. #	Castell interlock kit for 3VM10/ 11/ 12/ 13/ 14	5925.-



Notes:

# The 11<sup>th</sup> and 12<sup>th</sup> place of the type reference will indicate the alphabet type of lock & key. Combinations available are A, B, C, D, A-, -B, -C, AB, AC. 11<sup>th</sup> place will be A, B, C, D for castell lock type A, B, C, D respectively. 11<sup>th</sup> and 12<sup>th</sup> place will be A0, 0B, 0C, AB, AC for castell lock type A-, -B, -C, AB, AC respectively

<sup>®</sup> 1 set contains rotary mechanism, coupler, shaft and 8UC Front drive.

Spreader link 1 set = 3 nos. links and 2 nos. phase barriers in case of 3 pole; and 4 nos. links and 3 nos. phase barriers in case of 4 pole.

<sup>1)</sup> Rotary handles are not available for 1pole/ 2pole 3VM1 MCCBs

Std. Pkg. = 1 unit

\* LP - List Price

Circuit Breakers

## 3VT2..3

### Main switching unit without Trip Unit (ETU)

To be ordered along with trip unit

Frame Size	Breaking capacity (I <sub>cu</sub> , 415V AC, 50Hz)	Rated current I <sub>n</sub> (A)	3 pole		4 pole		Std. pkg. (nos.)
			Type	Unit LP* ₹	Type	Unit LP* ₹	
3VT2	36 kA	250	3VT2725-2AA36-0AA0	13795.-	3VT2725-2AA46-0AA0	21440.-	1
3VT3		630	3VT3763-2AA36-0AA0	33690.-	3VT3763-2AA46-0AA0	47450.-	1
3VT2	65 kA	250	3VT2725-3AA36-0AA0	17220.-	3VT2725-3AA46-0AA0	26730.-	1
3VT3		630	3VT3763-3AA36-0AA0	38595.-	3VT3763-3AA46-0AA0	51235.-	1



### Microprocessor based Trip Unit (ETU)

To be ordered along with the MCCB Main switching unit

Trip unit for system protection ETU LP, LI function (Fixed Overload & Fixed Short Circuit, 3P / 4P)

Frame size	Rated current I <sub>n</sub> (A)	Type	Unit LP* ₹	Std. pkg. (nos.)
3VT2	160	3VT9216-6AB00	12580.-	1
	200	3VT9220-6AB00	18865.-	1
3VT3	315	3VT9331-6AB00	25180.-	1
	400	3VT9340-6AB00	26765.-	1
	630	3VT9363-6AB00	32905.-	1

Trip unit for Motor & Generator Protection ETU MP, LI function (Adj Overload & Adj Short Circuit Settings 3P / 4P)

Frame size	Rated current I <sub>n</sub> (A)	Type	Unit LP* ₹	Std. pkg. (nos.)
3VT2	160	3VT9216-6AP00	15745.-	1
	250	3VT9225-6AP00	33055.-	1
3VT3	400	3VT9340-6AP00	33055.-	1
	630	3VT9363-6AP00	40935.-	1

Trip unit for system protection ETU DP, LI function (Adj Overload & Adj Short Circuit, 3P / 4P)<sup>s</sup>

Frame size	Rated current I <sub>n</sub> (A)	Type	Unit LP* ₹	Std. pkg. (nos.)
3VT2	100	3VT9210-6AC00	11115.-	1
	160	3VT9216-6AC00	15585.-	1
	250	3VT9225-6AC00	32975.-	1
3VT3	400	3VT9340-6AC00	28490.-	1
	630	3VT9363-6AC00	37465.-	1

#### Benefits of interchangeable trip units

- Suitable for various applications
- Easy upgradation at site

## Accessories for 3VT2..3

Accessory		3VT2 Type	Unit LP* ₹	3VT3 Type	Unit LP* ₹
Auxiliary Switch		3VT9300-2AF10 (1NO+1NC)	3455.-	3VT9300-2AF10 (1NO+1NC)	3455.-
		3VT9300-2AC10 (1NO)	1740.-	3VT9300-2AC10 (1NO)	1740.-
Alarm Switch		3VT9300-2AD10 (1NC)	1740.-	3VT9300-2AD10 (1NC)	1740.-
Shunt Release	AC 230V/DC 220V	3VT9300-1SE00\$	3910.-	3VT9300-1SE00\$	3910.-
Under-voltage Release	AC 230V/DC 220V	3VT9300-1UE00\$	4735.-	3VT9300-1UE00\$	4735.-
Spreader Links <sup>§</sup>	3 pole (1 set = 3 links + 2 phase barriers)	3VT9200-4ED30-ORC1	1515.-	3VT9300-4ED30-ORC1	2035.-
	4 pole (1 set = 4 links + 3 phase barriers)	3VT9200-4ED40-ORC1	2015.-	3VT9300-4ED40-ORC1	2635.-
Panel door mounted rotary operating handles <sup>2</sup>	1 set **	3VT9200-3HQ00	3040.-	3VT9300-3HQ00	3275.-
Castell Interlock Kit <sup>1</sup>	1 set (1 lock + 1 key)	8UC60701YQ..	5925.-	8UC60701YQ..	5925.-

Available till stocks last 3VT2..3 (Main Switching Unit + ETU) & accessories

\$ Also suitable for 400/500V AC

\*\* 1 set contains rotary mechanism, coupler, shaft and door drive

§ spreaders with higher phase-to-phase clearance

Std. Pkg. = 1 unit

\* LP - List Price

## MCCB: SENTRON 3VT4...5

- Rated current - 800A to 1600A
- Microprocessor based trip unit
- Adjustable settings
- Suitable for various applications
- Inbuilt extended terminals
- Higher clearances



### Main switching unit without Trip Unit (ETU)

To be ordered along with trip unit

### Microprocessor based Trip Unit (ETU)

To be ordered along with the MCCB Main switching unit



Trip unit for system protection ETU DP, LI function (Adj Overload & Adj Short Circuit)

Frame Size	Breaking capacity (I <sub>cu</sub> , 415V AC, 50Hz)	Rated current I <sub>n</sub> (A)	3 pole	
			Type	Unit LP* ₹
3VT4	65 kA	1000	3VT4710-3AA30-0AA0	64030.-
3VT5	55 kA	1600	3VT5716-3AA30-0AA0	96065.-

Frame size	Rated current I <sub>n</sub> (A)	Type	Unit LP* ₹
3VT4	800	3VT9480-6AC00	31180.-
	1000	3VT9410-6AC00	98190.-
3VT5	1250	3VT9512-6AC00	106360.-
	1600	3VT9516-6AC00	180000.-

## Accessories for 3VT4...5

Accessory	3VT4/5 Type	Unit LP* ₹
Auxiliary Switch	3VT9500-2AF10 (2NO+2NC)	5730.-
Alarm Switch	3VT9500-2AF10 (2NO+2NC)	5730.-
Shunt Release AC 230V/ DC 220V	3VT9500-1SJ00	4320.-

Accessory	3VT4/5 Type	Unit LP* ₹
Under-voltage Release AC 230V/ DC 220V	3VT9500-1UJ00	4690.-
Panel door mounted rotary operating handles 1 set **	3VT9500-3HQ00	6960.-
Castell Interlock Kit <sup>1</sup> 1 set (1 lock + 1 key)	8UC6070-2YQ..	6085.-

\*\* 1 set contains rotary mechanism, coupler, shaft and door drive

<sup>1</sup> The 11th and 12th place of the type reference will indicate the alphabet type of lock & key. Combinations available are A, B, C, D, A-, -B, -C, AB, AC. 11th place will be A, B, C, D for castell lock type A, B, C, D respectively. 11th and 12 place will be A0, 0B, 0C, AB, AC for castell lock type A-, -B, -C, AB, AC respectively.

### Main switching unit + Trip unit



Main switching unit



Trip unit



Complete unit





**SINOVA**

# 3VJ Moulded Case Circuit Breakers

**Simply Efficient**

- Rated current: 20A to 630A
- 1 pole, 2 pole, 3 pole & 4 pole versions
- Breaking capacity: 10kA to 55kA
- Thermal magnetic trip unit (FTFM, ATFM)
- Range of internal and external accessories

[www.siemens.co.in](http://www.siemens.co.in)

**SIEMENS**

## 3VJ Moulded Case Circuit Breaker

3VJ10 MCCB, Thermal Magnetic Trip Unit, Fixed Thermal Fixed Magnetic (FTFM), 415VAC, 50Hz

Frame Size	Breaking Capacity @415V AC, 50/60Hz	Rated Current In (A)	2 Pole Type	Unit MRP* ₹	3 Pole Type	Unit MRP* ₹	4 Pole Type	Unit MRP* ₹
3VJ10 (VJ1 125X)	10kA	20	3VJ1002-0DA22-0AA0	2930.-	3VJ1002-0DA32-0AA0	3630.-	3VJ1002-0EA42-0AA0	5205.-
		25	3VJ1092-0DA22-0AA0	2930.-	3VJ1092-0DA32-0AA0	3630.-	3VJ1092-0EA42-0AA0	5205.-
		32	3VJ1003-0DA22-0AA0	2930.-	3VJ1003-0DA32-0AA0	3630.-	3VJ1003-0EA42-0AA0	5205.-
		40	3VJ1004-0DA22-0AA0	2930.-	3VJ1004-0DA32-0AA0	3630.-	3VJ1004-0EA42-0AA0	5205.-
		50	3VJ1005-0DA22-0AA0	2930.-	3VJ1005-0DA32-0AA0	3630.-	3VJ1005-0EA42-0AA0	5205.-
		63	3VJ1006-0DA22-0AA0	2930.-	3VJ1006-0DA32-0AA0	3630.-	3VJ1006-0EA42-0AA0	5205.-
		80	3VJ1008-0DA22-0AA0	2930.-	3VJ1008-0DA32-0AA0	3630.-	3VJ1008-0EA42-0AA0	5205.-
		100	3VJ1010-0DA22-0AA0	2930.-	3VJ1010-0DA32-0AA0	3630.-	3VJ1010-0EA42-0AA0	5205.-
		125	3VJ1012-0DA22-0AA0	4520.-	3VJ1012-0DA32-0AA0	5445.-	3VJ1012-0EA42-0AA0	7810.-
	18kA	20	3VJ1002-1DA22-0AA0	4045.-	3VJ1002-1DA32-0AA0	5835.-	3VJ1002-1EA42-0AA0	7490.-
		25	3VJ1092-1DA22-0AA0	4045.-	3VJ1092-1DA32-0AA0	5835.-	3VJ1092-1EA42-0AA0	7490.-
		32	3VJ1003-1DA22-0AA0	4045.-	3VJ1003-1DA32-0AA0	5835.-	3VJ1003-1EA42-0AA0	7490.-
		40	3VJ1004-1DA22-0AA0	4045.-	3VJ1004-1DA32-0AA0	5835.-	3VJ1004-1EA42-0AA0	7490.-
		50	3VJ1005-1DA22-0AA0	4045.-	3VJ1005-1DA32-0AA0	5835.-	3VJ1005-1EA42-0AA0	7490.-
		63	3VJ1006-1DA22-0AA0	4045.-	3VJ1006-1DA32-0AA0	5835.-	3VJ1006-1EA42-0AA0	7490.-
		80	3VJ1008-1DA22-0AA0	4045.-	3VJ1008-1DA32-0AA0	5835.-	3VJ1008-1EA42-0AA0	7490.-
		100	3VJ1010-1DA22-0AA0	4045.-	3VJ1010-1DA32-0AA0	5835.-	3VJ1010-1EA42-0AA0	7490.-
		125	3VJ1012-1DA22-0AA0	4685.-	3VJ1012-1DA32-0AA0	6695.-	3VJ1012-1EA42-0AA0	8710.-
	25kA	20	3VJ1002-3DA22-0AA0	4855.-	3VJ1002-3DA32-0AA0	6370.-	3VJ1002-3EA42-0AA0	8445.-
		25	3VJ1092-3DA22-0AA0	4855.-	3VJ1092-3DA32-0AA0	6370.-	3VJ1092-3EA42-0AA0	8445.-
		32	3VJ1003-3DA22-0AA0	4855.-	3VJ1003-3DA32-0AA0	6370.-	3VJ1003-3EA42-0AA0	8445.-
		40	3VJ1004-3DA22-0AA0	4855.-	3VJ1004-3DA32-0AA0	6370.-	3VJ1004-3EA42-0AA0	8445.-
		50	3VJ1005-3DA22-0AA0	4855.-	3VJ1005-3DA32-0AA0	6370.-	3VJ1005-3EA42-0AA0	8445.-
		63	3VJ1006-3DA22-0AA0	4855.-	3VJ1006-3DA32-0AA0	6370.-	3VJ1006-3EA42-0AA0	8445.-
		80	3VJ1008-3DA22-0AA0	4855.-	3VJ1008-3DA32-0AA0	6370.-	3VJ1008-3EA42-0AA0	8445.-
		100	3VJ1010-3DA22-0AA0	4855.-	3VJ1010-3DA32-0AA0	6370.-	3VJ1010-3EA42-0AA0	8445.-
		125	3VJ1012-3DA22-0AA0	4855.-	3VJ1012-3DA32-0AA0	7275.-	3VJ1012-3EA42-0AA0	9285.-

Notes:

Phase barriers are included in the standard MCCB packing

^2P in 3P Frame Size

Std. Pkg. = 1 unit

\* MRP - Max. Retail Price



## 3VJ MCCB, Thermal Magnetic Trip Unit, Fixed Thermal Fixed Magnetic (FTFM), 415VAC, 50Hz

Frame Size	Breaking Capacity @415V AC, 50/60Hz	Rated Current In (A)	2 <sup>^</sup> Pole Type	Unit MRP* ₹	3 Pole Type	Unit MRP* ₹	4 Pole Type	Unit MRP* ₹
3VJ12 (VJ1 250)	25kA	160	3VJ1216-3DA22-0AA0	9860.-	3VJ1216-3DA32-0AA0	11435.-	3VJ1216-3EA42-0AA0	15045.-
		200	3VJ1220-3DA22-0AA0	9970.-	3VJ1220-3DA32-0AA0	11610.-	3VJ1220-3EA42-0AA0	16515.-
		250	3VJ1225-3DA22-0AA0	10075.-	3VJ1225-3DA32-0AA0	13065.-	3VJ1225-3EA42-0AA0	17205.-
3VJ13 (VJ1 400)		320	-	-	3VJ1332-3DA32-0AA0	25885.-	3VJ1332-3EA42-0AA0	33330.-
		400	-	-	3VJ1340-3DA32-0AA0	25885.-	3VJ1340-3EA42-0AA0	33330.-
3VJ11 (VJ1 125)	36kA	25	3VJ1192-5DA22-0AA0	7470.-	3VJ1192-5DA32-0AA0	8890.-	3VJ1192-5EA42-0AA0	11745.-
		32	3VJ1103-5DA22-0AA0	7470.-	3VJ1103-5DA32-0AA0	8890.-	3VJ1103-5EA42-0AA0	11745.-
		40	3VJ1104-5DA22-0AA0	7470.-	3VJ1104-5DA32-0AA0	8890.-	3VJ1104-5EA42-0AA0	11745.-
		50	3VJ1105-5DA22-0AA0	7470.-	3VJ1105-5DA32-0AA0	8890.-	3VJ1105-5EA42-0AA0	11745.-
		63	3VJ1106-5DA22-0AA0	7470.-	3VJ1106-5DA32-0AA0	8890.-	3VJ1106-5EA42-0AA0	11745.-
		80	3VJ1108-5DA22-0AA0	7470.-	3VJ1108-5DA32-0AA0	9155.-	3VJ1108-5EA42-0AA0	12105.-
		100	3VJ1110-5DA22-0AA0	7470.-	3VJ1110-5DA32-0AA0	9155.-	3VJ1110-5EA42-0AA0	12105.-
3VJ12 (VJ1 250)		125	3VJ1112-5DA22-0AA0	7470.-	3VJ1112-5DA32-0AA0	10065.-	3VJ1112-5EA42-0AA0	13160.-
		160	3VJ1216-5DA22-0AA0	10405.-	3VJ1216-5DA32-0AA0	12805.-	3VJ1216-5EA42-0AA0	15570.-
		200	3VJ1220-5DA22-0AA0	10955.-	3VJ1220-5DA32-0AA0	15790.-	3VJ1220-5EA42-0AA0	20375.-
3VJ13 (VJ1 400)		250	3VJ1225-5DA22-0AA0	12365.-	3VJ1225-5DA32-0AA0	18145.-	3VJ1225-5EA42-0AA0	23350.-
		320	-	-	3VJ1332-5DA32-0AA0	26530.-	3VJ1332-5EA42-0AA0	33985.-
3VJ14 (VJ1 630) <b>NEW</b>		400	-	-	3VJ1340-5DA32-0AA0	26530.-	3VJ1340-5EA42-0AA0	33985.-
		500	-	-	3VJ1450-5DA32-0AA0	39800.-	3VJ1450-5EA42-0AA0	50975.-
3VJ14 (VJ1 630) <b>NEW</b>		630	-	-	3VJ1463-5DA32-0AA0	39800.-	3VJ1463-5EA42-0AA0	50975.-
		25	3VJ1192-7DA22-0AA0	7865.-	3VJ1192-7DA32-0AA0	11370.-	3VJ1192-7EA42-0AA0	15000.-
3VJ11 (VJ1 125)	55kA	32	3VJ1103-7DA22-0AA0	7865.-	3VJ1103-7DA32-0AA0	11370.-	3VJ1103-7EA42-0AA0	15000.-
		40	3VJ1104-7DA22-0AA0	7865.-	3VJ1104-7DA32-0AA0	11370.-	3VJ1104-7EA42-0AA0	15000.-
		50	3VJ1105-7DA22-0AA0	7865.-	3VJ1105-7DA32-0AA0	11370.-	3VJ1105-7EA42-0AA0	15000.-
		63	3VJ1106-7DA22-0AA0	7865.-	3VJ1106-7DA32-0AA0	11370.-	3VJ1106-7EA42-0AA0	15000.-
		80	3VJ1108-7DA22-0AA0	7865.-	3VJ1108-7DA32-0AA0	11370.-	3VJ1108-7EA42-0AA0	15000.-
		100	3VJ1110-7DA22-0AA0	7865.-	3VJ1110-7DA32-0AA0	11370.-	3VJ1110-7EA42-0AA0	15000.-
		125	3VJ1112-7DA22-0AA0	7865.-	3VJ1112-7DA32-0AA0	12515.-	3VJ1112-7EA42-0AA0	16500.-
3VJ12 (VJ1 250)		160	3VJ1216-7DA22-0AA0	11280.-	3VJ1216-7DA32-0AA0	15835.-	3VJ1216-7EA42-0AA0	20920.-
		200	3VJ1220-7DA22-0AA0	11500.-	3VJ1220-7DA32-0AA0	18210.-	3VJ1220-7EA42-0AA0	24050.-
		250	3VJ1225-7DA22-0AA0	12595.-	3VJ1225-7DA32-0AA0	20940.-	3VJ1225-7EA42-0AA0	27660.-
3VJ13 (VJ1 400)		320	-	-	3VJ1332-7DA32-0AA0	27180.-	3VJ1332-7EA42-0AA0	34955.-
		400	-	-	3VJ1340-7DA32-0AA0	27180.-	3VJ1340-7EA42-0AA0	34955.-
3VJ14 (VJ1 630) <b>NEW</b>		500	-	-	3VJ1450-7DA32-0AA0	40770.-	3VJ1450-7EA42-0AA0	52430.-
		630	-	-	3VJ1463-7DA32-0AA0	40770.-	3VJ1463-7EA42-0AA0	52430.-

## Notes:

Phase barriers are included in the standard MCCB packing

^2P in 3P Frame Size

Std. Pkg. = 1 unit

\* MRP - Max. Retail Price



3VJ10 MCCB, Thermal Magnetic Trip Unit, Adjustable Thermal Fixed Magnetic (ATFM), 415VAC, 50Hz

Frame Size	Breaking Capacity @415V AC, 50/60Hz	Rated Current In (A)	3 Pole Type	Unit MRP* ₹	4 Pole Type	Unit MRP* ₹
3VJ10 (VJ1 125X)	10kA	20	3VJ1002-0DB32-0AA0	4630.-	3VJ1002-0EB42-0AA0	6255.-
		25	3VJ1092-0DB32-0AA0	4630.-	3VJ1092-0EB42-0AA0	6255.-
		32	3VJ1003-0DB32-0AA0	4630.-	3VJ1003-0EB42-0AA0	6255.-
		40	3VJ1004-0DB32-0AA0	4630.-	3VJ1004-0EB42-0AA0	6255.-
		50	3VJ1005-0DB32-0AA0	4630.-	3VJ1005-0EB42-0AA0	6255.-
		63	3VJ1006-0DB32-0AA0	4630.-	3VJ1006-0EB42-0AA0	6255.-
		80	3VJ1008-0DB32-0AA0	4630.-	3VJ1008-0EB42-0AA0	6255.-
		100	3VJ1010-0DB32-0AA0	4630.-	3VJ1010-0EB42-0AA0	6255.-
		125	3VJ1012-0DB32-0AA0	6660.-	3VJ1012-0EB42-0AA0	9395.-
	18kA	20	3VJ1002-1DB32-0AA0	6995.-	3VJ1002-1EB42-0AA0	8985.-
		25	3VJ1092-1DB32-0AA0	6995.-	3VJ1092-1EB42-0AA0	8985.-
		32	3VJ1003-1DB32-0AA0	6995.-	3VJ1003-1EB42-0AA0	8985.-
		40	3VJ1004-1DB32-0AA0	6995.-	3VJ1004-1EB42-0AA0	8985.-
		50	3VJ1005-1DB32-0AA0	6995.-	3VJ1005-1EB42-0AA0	8985.-
		63	3VJ1006-1DB32-0AA0	6995.-	3VJ1006-1EB42-0AA0	8985.-
		80	3VJ1008-1DB32-0AA0	6995.-	3VJ1008-1EB42-0AA0	8985.-
		100	3VJ1010-1DB32-0AA0	6995.-	3VJ1010-1EB42-0AA0	8985.-
		125	3VJ1012-1DB32-0AA0	8025.-	3VJ1012-1EB42-0AA0	10440.-
	25kA	20	3VJ1002-3DB32-0AA0	8040.-	3VJ1002-3EB42-0AA0	10660.-
		25	3VJ1092-3DB32-0AA0	8040.-	3VJ1092-3EB42-0AA0	10660.-
		32	3VJ1003-3DB32-0AA0	8040.-	3VJ1003-3EB42-0AA0	10660.-
		40	3VJ1004-3DB32-0AA0	8040.-	3VJ1004-3EB42-0AA0	10660.-
		50	3VJ1005-3DB32-0AA0	8040.-	3VJ1005-3EB42-0AA0	10660.-
		63	3VJ1006-3DB32-0AA0	8040.-	3VJ1006-3EB42-0AA0	10660.-
		80	3VJ1008-3DB32-0AA0	8040.-	3VJ1008-3EB42-0AA0	10660.-
		100	3VJ1010-3DB32-0AA0	8040.-	3VJ1010-3EB42-0AA0	10660.-
		125	3VJ1012-3DB32-0AA0	9175.-	3VJ1012-3EB42-0AA0	11720.-

Notes:  
 Phase barriers are included in the standard MCCB packing  
 Std. Pkg. = 1 unit \* MRP - Max. Retail Price



## 3VJ MCCB, Thermal Magnetic Trip Unit, Adjustable Thermal Fixed Magnetic (ATFM), 415VAC, 50Hz

Frame Size	Breaking Capacity @415V AC, 50/60Hz	Rated Current In (A)	3 Pole Type	Unit MRP* ₹	4 Pole Type	Unit MRP* ₹	
3VJ12 (VJ1 250)	25kA	160	3VJ1216-3DB32-0AA0	12895.-	3VJ1216-3EB42-0AA0	15690.-	
		200	3VJ1220-3DB32-0AA0	13920.-	3VJ1220-3EB42-0AA0	17520.-	
		250	3VJ1225-3DB32-0AA0	15670.-	3VJ1225-3EB42-0AA0	20630.-	
3VJ13 (VJ1 400)		320	3VJ1332-3DB32-0AA0	29315.-	3VJ1332-3EB42-0AA0	37755.-	
		400	3VJ1340-3DB32-0AA0	29315.-	3VJ1340-3EB42-0AA0	37755.-	
		3VJ11 (VJ1 125)	25	3VJ1192-5DB32-0AA0	10660.-	3VJ1192-5EB42-0AA0	14080.-
32	3VJ1103-5DB32-0AA0		10660.-	3VJ1103-5EB42-0AA0	14080.-		
40	3VJ1104-5DB32-0AA0		10660.-	3VJ1104-5EB42-0AA0	14080.-		
50	3VJ1105-5DB32-0AA0		10660.-	3VJ1105-5EB42-0AA0	14080.-		
63	3VJ1106-5DB32-0AA0		10660.-	3VJ1106-5EB42-0AA0	14080.-		
80	3VJ1108-5DB32-0AA0		10660.-	3VJ1108-5EB42-0AA0	14080.-		
100	3VJ1110-5DB32-0AA0		10660.-	3VJ1110-5EB42-0AA0	14080.-		
125	3VJ1112-5DB32-0AA0		12070.-	3VJ1112-5EB42-0AA0	15310.-		
3VJ12 (VJ1 250)	36kA		160	3VJ1216-5DB32-0AA0	14625.-	3VJ1216-5EB42-0AA0	17780.-
			200	3VJ1220-5DB32-0AA0	18930.-	3VJ1220-5EB42-0AA0	24435.-
		250	3VJ1225-5DB32-0AA0	21765.-	3VJ1225-5EB42-0AA0	28005.-	
3VJ13 (VJ1 400)		320	3VJ1332-5DB32-0AA0	30050.-	3VJ1332-5EB42-0AA0	38490.-	
		400	3VJ1340-5DB32-0AA0	30050.-	3VJ1340-5EB42-0AA0	38490.-	
3VJ14 (VJ1 630)		500	3VJ1450-5DB32-0AA0	45075.-	3VJ1450-5EB42-0AA0	57735.-	
		630	3VJ1463-5DB32-0AA0	45075.-	3VJ1463-5EB42-0AA0	57735.-	
3VJ11 (VJ1 125)		55kA	25	3VJ1192-7DB32-0AA0	12880.-	3VJ1192-7EB42-0AA0	16985.-
			32	3VJ1103-7DB32-0AA0	12880.-	3VJ1103-7EB42-0AA0	16985.-
			40	3VJ1104-7DB32-0AA0	12880.-	3VJ1104-7EB42-0AA0	16985.-
	50		3VJ1105-7DB32-0AA0	12880.-	3VJ1105-7EB42-0AA0	16985.-	
	63		3VJ1106-7DB32-0AA0	12880.-	3VJ1106-7EB42-0AA0	16985.-	
	80		3VJ1108-7DB32-0AA0	12880.-	3VJ1108-7EB42-0AA0	16985.-	
	100		3VJ1110-7DB32-0AA0	12880.-	3VJ1110-7EB42-0AA0	16985.-	
	125		3VJ1112-7DB32-0AA0	14170.-	3VJ1112-7EB42-0AA0	18690.-	
	3VJ12 (VJ1 250)		160	3VJ1216-7DB32-0AA0	16955.-	3VJ1216-7EB42-0AA0	22395.-
			200	3VJ1220-7DB32-0AA0	19500.-	3VJ1220-7EB42-0AA0	25745.-
250		3VJ1225-7DB32-0AA0	22415.-	3VJ1225-7EB42-0AA0	29610.-		
3VJ13 (VJ1 400)	320	3VJ1332-7DB32-0AA0	30790.-	3VJ1332-7EB42-0AA0	39590.-		
	400	3VJ1340-7DB32-0AA0	30790.-	3VJ1340-7EB42-0AA0	39590.-		
3VJ14 (VJ1 630)	500	3VJ1450-7DB32-0AA0	46180.-	3VJ1450-7EB42-0AA0	59385.-		
	630	3VJ1463-7DB32-0AA0	46180.-	3VJ1463-7EB42-0AA0	59385.-		

Notes: Phase barriers are included in the standard MCCB packing

## Earth Fault Protection for 3VJ MCCBs

Description	Type	Unit LP* ₹	
Earth fault monitoring relay	7UG0861-1BU20	5,805	
CBCT for EFR: Suitable for 3VJ10 up to 125A	3P 4P	7UG09910 7UG09911	2005.- 2285.-
CBCT for EFR: Suitable for 3VJ11 up to 125A	3P 4P	7UG09911 7UG09911	2420.- 2850.-
CBCT for EFR: Suitable for 3VJ12 up to 250A	3P 4P	7UG09912 7UG09913	3565.- 3855.-

## Earth Leakage Protection for 3VJ MCCBs

Description	Type	Unit LP* ₹	
Earth leakage relay 1Ph-2W, 3Ph-3W, 3Ph-4W	110VAC	7UG0841-1CB20	5615.-
	230VAC	7UG0842-1CD20	5670.-
CBCT for ELR	35 mm dia	7UG0996	2045.-
	70 mm dia	7UG0997	2335.-
	120 mm dia	7UG0999	3975.-
	210 mm dia	7UG0994	7650.-
	310 mm dia	7UG0995	11400.-

Note: Order 1 no of shunt trip for MCCB separately along with earth fault relay / earth leakage relay

Std. Pkg. = 1 unit

\* MRP - Max. Retail Price

LP = List Price

## 3VJ Internal accessories

Frame Size	Accessory compartment/ Coil voltage	3VJ10 (VJ1 125X)	Unit MRP* ₹	3VJ11 (VJ1 125)	Unit MRP* ₹	3VJ12 (VJ1 250)	Unit MRP* ₹	3VJ13/14 (VJ1 400/630)	Unit MRP* ₹
Auxiliary Switches (AUX)	Left	3VJ9018-0AN11	1595.-	3VJ9218-0AN11	1650.-	3VJ9218-0AN11	1650.-	3VJ9417-0AN11	1705.-
	Right	-	-	3VJ9218-0AN21	1650.-	3VJ9218-0AN21	1650.-	3VJ9417-0AN21	1705.-
Alarm Switches (AL)	Left	3VJ9018-0AA11	1595.-	3VJ9118-0AA11	1595.-	3VJ9218-0AA11	1650.-	3VJ9417-0AA11	1705.-
	Right	-	-	3VJ9118-0AA21	1595.-	3VJ9218-0AA21	1650.-	3VJ9417-0AA21	1705.-
Auxiliary + Alarm Switches (AUX+AL)	Left	3VJ9018-0AD11	2590.-	3VJ9118-0AD11	2590.-	3VJ9218-0AD11	2715.-	3VJ9417-0AD11	2945.-
	Right	-	-	3VJ9118-0AD21	2590.-	3VJ9218-0AD21	2715.-	3VJ9417-0AD21	2945.-
Shunt Trip (Right) (ST)	24V DC	-	-	3VJ9218-0ST11	3300.-	3VJ9218-0ST11	3300.-	-	-
	24V AC/DC	-	-	-	-	-	-	3VJ9417-0ST21	3535.-
	48V DC	-	-	3VJ9218-0ST12	3300.-	3VJ9218-0ST12	3300.-	-	-
	48V AC/DC	-	-	-	-	-	-	3VJ9417-0ST22	3535.-
	110V DC	3VJ9018-0ST15	2400.-	3VJ9218-0ST15	3300.-	3VJ9218-0ST15	3300.-	-	-
	110V AC/DC	-	-	-	-	-	-	3VJ9417-0ST25	3535.-
	110V AC	3VJ9018-0ST35	2400.-	3VJ9218-0ST35	3420.-	3VJ9218-0ST35	3420.-	-	-
	220V AC	3VJ9018-0ST36	2600.-	3VJ9218-0ST36	3535.-	3VJ9218-0ST36	3535.-	3VJ9417-0ST36	3890.-
Undervoltage Release (Left) (UVR)	415V AC	3VJ9018-0ST37	2600.-	3VJ9218-0ST37	3535.-	3VJ9218-0ST37	3535.-	3VJ9417-0ST37	3890.-
	24V DC	-	-	3VJ9218-0UV11	4715.-	3VJ9218-0UV11	4715.-	-	-
	48V DC	-	-	3VJ9218-0UV12	4715.-	3VJ9218-0UV12	4715.-	-	-
	220V AC	-	-	3VJ9218-0UV36	4950.-	3VJ9218-0UV36	4950.-	3VJ9417-0UV36	11795.-
415V AC	-	-	3VJ9218-0UV37	5305.-	3VJ9218-0UV37	5305.-	3VJ9417-0UV37	11795.-	

Internal accessories are available for 2P, 3P &amp; 4P 3VJ MCCBs

## 3VJ External accessories

Frame Size	No. of poles	3VJ10 (VJ1 125X)	Unit MRP* ₹	3VJ11 (VJ1 125)	Unit MRP* ₹	3VJ12 (VJ1 250)	Unit MRP* ₹	3VJ13 (VJ1 400)	Unit MRP* ₹	3VJ14 (VJ1 630)	Unit MRP* ₹
Extended Door Mounted Rotary Operator (including 8UC handle)@	-	3VJ9018-0HD11	2390.-	3VJ9118-0HD11	2570.-	3VJ9218-0HD11	3010.-	3VJ9417-0HD11	3800.-	3VJ9417-0HD11	3800.-
Spreader Links^	2P	3VJ9012-0ED00	210.-	3VJ9112-0ED00	235.-	3VJ9212-0ED00	710.-	-	-	-	-
	3P	3VJ9013-0ED00	355.-	3VJ9113-0ED00	375.-	3VJ9213-0ED00	1150.-	3VJ9313-0ED00	2005.-	3VJ9413-0ED00 <b>NEW</b>	2405.-
	4P	3VJ9014-0ED00	465.-	3VJ9114-0ED00	490.-	3VJ9214-0ED00	1495.-	3VJ9314-0ED00	2830.-	3VJ9414-0ED00 <b>NEW</b>	3395.-
Phase Barriers#		3VJ9018-0CA00	165.-	3VJ9218-0CA00	260.-	3VJ9218-0CA00	260.-	3VJ9417-0CA00	285.-	3VJ9417-0CA00	285.-
Front Barriers\$	2P/3P	3VJ9016-0CJ30	380.-	3VJ9116-0CJ30	450.-	3VJ9216-0CJ30	650.-	3VJ9413-0CJ30	810.-	3VJ9413-0CJ30	810.-
	4P	3VJ9014-0CJ40	535.-	3VJ9114-0CJ40	570.-	3VJ9214-0CJ40	760.-	3VJ9414-0CJ40	995.-	3VJ9414-0CJ40	995.-
Toggle handle extension	-	-	-	-	-	-	-	3VJ9417-0DH10	645.-	3VJ9417-0DH10	645.-
Interlocking (for MCCBs with 8UC handles) - Castell interlock kit	-	8UC60701YQ..	5925.-	8UC60701YQ..	5925.-	8UC60701YQ..	5925.-	8UC60702YQ..	6085.-	8UC60702YQ..	6085.-
SS Enclosures <b>NEW</b>	2P/3P	3VJ9016-0DE11	2665.-	3VJ9116-0DE11	2665.-	3VJ9216-0DE12	5845.-	-	-	-	-
	4P	3VJ9014-0DE11	2665.-	3VJ9114-0DE11	2665.-	3VJ9214-0DE12	5845.-	-	-	-	-

## Notes:

@ 1 set contains rotary mechanism, coupler, shaft &amp; 8UC handle.

^ Spreader link 1 set = 2 nos. links in case of 2 pole; 3 nos. links in case of 3 pole; 4 nos. links in case of 4 pole.

# Available as a spare; 1 set contains 2 phase barriers

\$ 1 set contains 2 front barriers (top &amp; bottom)

Toggle handle extension is included in the standard packing of 3VJ13 (VJ1 400) MCCB.

2P/3P SS enclosures provide inbuilt neutral link for TPN system

Std. Pkg. = 1 unit

\* MRP - Max. Retail Price



SENTRON

# Transfer control devices

## 3KC ATC6300 & 6500

- Suitable for Utility to DG, Utility to Utility and DG to DG changeover in combination with motorized breakers
- Automatic Load management and control of tie breaker (with ATC 6500 only)
- Communication capable via expansion modules on Modbus TCP or MODBUS RTU
- Confirms to IEC 60947-6-1
- Plug-in DI/DO expansion modules for additional functionality
- Easy parameterization through Powerconfig
- Ingress protection up to IP65

[www.siemens.com/switching-devices](http://www.siemens.com/switching-devices)

**SIEMENS**

# SENTRON Auto transfer controllers

In accordance with IEC 60947-6-1, IEC standard for transfer switching equipments



	3KC ATC 6300	3KC ATC 6500
Display	Yes, LCD	Yes, LCD
Network	Single Phase / 2 Phase or 3 Phase systems (Including 3 Phase – 4 Wire systems)	Single Phase / 2 Phase or 3 Phase systems (Including 3 Phase – 4 Wire systems)
Maximum rated voltage U <sub>e</sub>	100-480V AC L-L	100-600V AC L-L
Application type	Utility – Utility Utility - DG DG - DG	Utility – Utility Utility - DG DG - DG
Number of controllable breakers	2	3
Automatic load management (load shedding)	No	Yes
Parameterization	LCD Display   USB Front interface <sup>1)</sup>   Communication Modules <sup>2)</sup>	LCD Display   USB Front interface <sup>1)</sup>   Communication Modules <sup>2)</sup>
Expansion Modules	Yes, DI/DOs   Communication Modules	Yes, DI/DOs   Communication Modules
Communication Option	Yes, MODBUS RTU/ MODBUS TCP via expansion modules	Yes, Integrated RS485 Port (MODBUS RTU) MODBUS TCP via expansion module

<sup>1) 2)</sup> Available as accessory. Parameterization to be done via Powerconfig

Description	Type No	Unit LP* ₹	Std. pkg. (nos.)
<b>Automatic Transfer Controllers</b>			
3KC ATC 6300	3KC9000-8TL40	120275.-	1
3KC ATC 6500	3KC9000-8TL50	POR	1
<b>Accessories   Expandable DI /DO Modules (For both ATC 6300 &amp; 6500)</b>			
ATC6 expansion module 4DI	3KC9000-8TL60	POR	1
ATC6 expansion module 4DO, SSR	3KC9000-8TL61	POR	1
ATC6 expansion module 2DI/2DO, SSR	3KC9000-8TL62	POR	1
ATC6 expansion module 2DO, relay	3KC9000-8TL63	POR	1
ATC6 expansion module 2DI/2DO, relay	3KC9000-8TL64	POR	1
<b>Expansion modules with communication interfaces (For both ATC 6300 &amp; 6500)</b>			
ATC6 RS 485 expansion module	3KC9000-8TL74	POR	1
ATC6 Ethernet expansion module	3KC9000-8TL75	POR	1
<b>USB Front interface (For both ATC 6300 &amp; 6500)</b>			
ATC6 USB front interface	3KC9000-8TL73	POR	1
<b>IP 65 Protective Gasket</b>			
For ATC 6300 144 x 144 mm	3KC9000-8TL67	POR	1
For ATC 6500 171 x 131 mm	3KC9000-8TL68	POR	1

POR: Price On Request

\* LP - List Price

Auto Transfer Controllers

**Complete Auto changeover solution with SIEMENS circuit breakers**

Designed and tested with







SENTRON

# Fuse Switch Disconnectors - 3NP1

End to end safety for user and systems

- Compliant with IEC 60947-1 and IEC 60947-3
- 1-pole to 4-pole versions up to 630A at 1000V AC/ DC
- Fuse and Voltage monitoring
- 40/ 60mm busbar mounting option
- Selection chart with SITOR fuses

[www.siemens.com/switching-devices](http://www.siemens.com/switching-devices)

**SIEMENS**

# SETRON 3NP1 Fuse Switch Disconnectors up to 630A

## Reliable safety of personnel and systems

**Overview:**

- Available in five frame sizes from 100 to 630 A
- Optional for use of fuse links in LV HRC design
- 1-, 2-, 3- and 4-pole switchable

**Application:**

- Can be used in main and auxiliary circuits
- For non-routine switching
- VFD/ Soft Starter/ Capacitor panels

**Benefits:**

- Fuse puller is not required
- Mounting flexibility: Base / DIN / busbar
- AC20 / DC20 1000V

### 3NP1 with Floor mounting

**3NP1 without fuse monitoring**

Rated current (A)	3NP1 size	DIN fuse size	Terminals type	Poles <sup>4)</sup>	Type	Unit LP* ₹
100 <sup>1)</sup>	000	000	Box	1	3NP1121-1CA20	4170.-
				3	3NP1123-1CA20	7580.-
				4	3NP1124-1CA20	13230.-
160 <sup>2)</sup>	00	000,00	Flat	1	3NP1131-1CA10	4390.-
				3	3NP1133-1CA10	7925.-
				4	3NP1134-1CA10	13790.-
250 <sup>2)</sup>	1	00,1	Flat	1	3NP1141-1DA10	12790.-
				3	3NP1143-1DA10	23190.-
				4	3NP1144-1DA10	38020.-
400 <sup>2)</sup>	2	1,2	Flat	1	3NP1151-1DA10	17590.-
				3	3NP1153-1DA10	31780.-
				4	3NP1154-1DA10	51430.-
630 <sup>2)</sup>	3	2,3	Flat	1	3NP1161-1DA10	23410.-
				3	3NP1163-1DA10	42580.-
				4	3NP1164-1DA10	68235.-



1-pole



3-pole



2-pole



4-pole

**3NP1 with Electronic fuse monitoring <sup>3)</sup>**

Rated current (A)	3NP1 size	DIN fuse size	Terminals type	Poles <sup>4)</sup>	Type	Unit LP* ₹
100 <sup>1)</sup>	000	000	Box	1	3NP1121-1CA24	14610.-
				3	3NP1123-1CA24	22615.-
160 <sup>2)</sup>	00	000,00	Flat	1	3NP1131-1CA14	13955.-
				3	3NP1133-1CA14	22820.-
250 <sup>2)</sup>	1	00,1	Flat	1	3NP1141-1DA14	23215.-
				3	3NP1143-1DA14	38020.-
400 <sup>2)</sup>	2	1,2	Flat	1	3NP1151-1DA14	28215.-
				3	3NP1153-1DA14	47025.-
630 <sup>2)</sup>	3	2,3	Flat	1	3NP1161-1DA14	34025.-
				3	3NP1163-1DA14	57435.-



1-pole with EFM



3-pole with EFM

- 1) Can be used up to 160A along with an accessory feeder terminal 3NP1923-1BD00 (for 3-pole) and 3NP1921-1BD00 (for 1-pole)
- 2) Box type terminals available for higher ratings 3NP1.
- 3) EFM voltage range: 1-pole: 24 ... 240 V AC (phase to N) / 24 ... 250 V DC (L+ to L-); 3-pole: 190 ... 690 V AC (phase to phase) .

Further voltage ranges are available as accessories. EFM needs external 24V DC power supply.

- 4) 2-pole 3NP1 is a combination of 2 nos. 1-pole 3NP1 with assembly kit accessories. Please refer page 43 for assembly kit selection.

### Configurator for 3NP1

- Ready-to-install version
- Application specific switches
- Accessories



Load Break Switches

## 3NP1 mounting on 8US busbar

### 3NP1 mounting on 60mm 8US busbar system <sup>3)</sup>

3NP1 without fuse monitoring

Rated current (A)	3NP1 size	DIN fuse size	Terminals type	Poles <sup>4)</sup>	Type	Unit LP* ₹
100 <sup>1)</sup>	000	000	Box	3	3NP1123-1BC20	11215.-
				4	3NP1124-1BC20	18685.-
160 <sup>2)</sup>	00	00	Flat	3	3NP1133-1BC10	12040.-
				4	3NP1134-1BC10	20135.-
250 <sup>2)</sup>	1	1	Flat	3	3NP1143-1BC10	38385.-
				4	3NP1144-1BC10	59830.-
400 <sup>2)</sup>	2	2	Flat	3	3NP1153-1BC10	49610.-
				4	3NP1154-1BC10	77840.-
630 <sup>2)</sup>	3	3	Flat	3	3NP1163-1BC10	62965.-
				4	3NP1164-1BC10	99880.-

8US busbar system

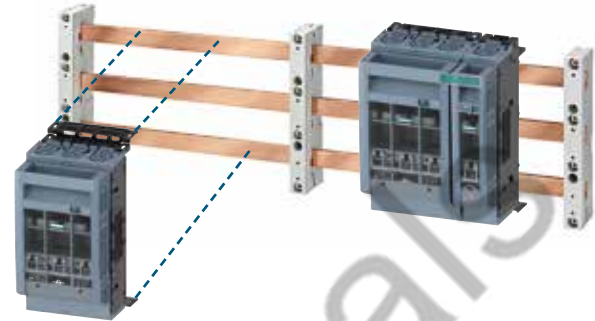

## Accessories for 3NP1

### Auxiliary contact (1CO type)

3NP1 Size	Type	Unit LP* ₹
000	3NP1920-1FA00	1745.-
00	3NP1930-1FA00	1745.-
1,2,3	3NP1940-1FA00	1900.-

### Feeder terminals for 3NP1 121/ 3 for use up to 160A

3NP1 Size	Terminals type	Poles	Type	Unit LP* ₹
000	Box	1	3NP1921-1BD00	2200.-
		3	3NP1923-1BD00	4915.-

### Assembly kit for connection of 1-pole and 3-pole 3NP1 to form floor mounted 2-pole<sup>4)</sup> and 4-pole 3NP1

3NP1 Size	Type	Unit LP* ₹
000	3NP19211EC00	POR
00	3NP19311EC00	
1,2,3	3NP19411EC00	

### Assembly kit for mounting 3NP1 floor type on 8US 60mm busbar system <sup>5)</sup>

3NP1 Size	Terminals type	Poles	Type	Unit LP* ₹
000	Box	1	3NP1921-1EE10	POR
00			3NP1931-1EE10	

- 1) Can be used up to 160A along with an accessory feeder terminal 3NP1923-1BD00 (for 3-pole) and 3NP1921-1BD00 (for 1-pole)
- 2) Box type terminals available for higher ratings 3NP1.
- 3) 3NP1 also available for Rittal RiLine 60 busbar system with base
- 4) 2-pole 3NP1 is a combination of 2 nos. 1-pole 3NP1 with assembly kit accessories.
- 5) Contains all parts for assembly and connection.

POR: Price On Request

Std. Pkg. = 1 unit

\* LP - List Price

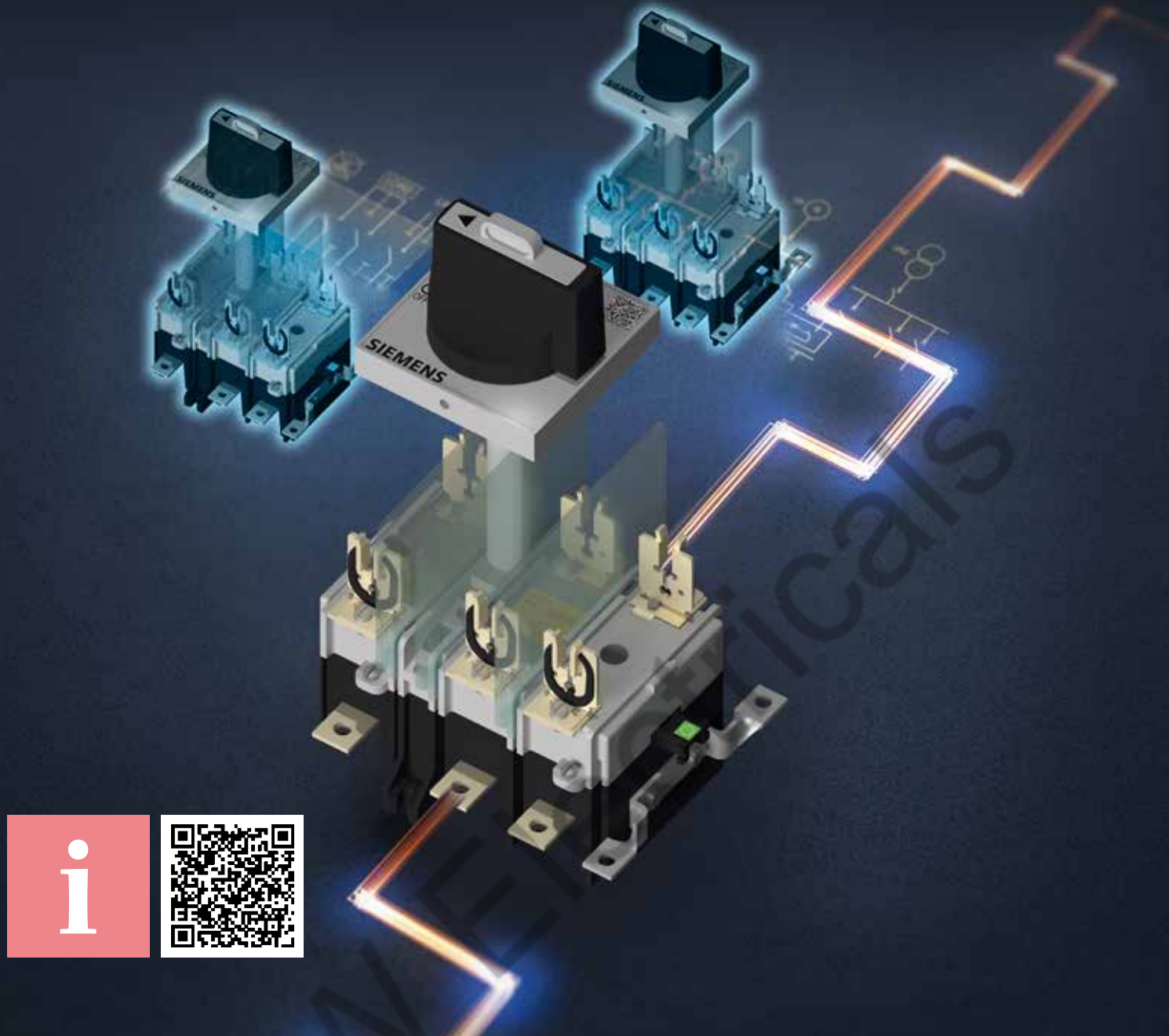

**SUPERSWITCH**

# Switch Disconnecter Fuse - **3KL8**

**Safe. Reliable. Efficient.**

- Compliant with IS/ IEC 60947-3
- 2-pole to 4-pole versions up to 800A at 690V AC
- COMPACT 2-pole and TRUE 4-pole versions
- DIN/ BS/ Cylindrical fuse type versions
- With Enclosure option
- AC-23A for the complete range
- Type 2 co-ordination chart for DOL and Star Delta feeders

[www.siemens.co.in/superswitch3k](http://www.siemens.co.in/superswitch3k)

**SIEMENS**

# Superswitch 3KL8

- Wide range : Up to 800A in SDF and 1600A in SD
- Available in 2P,3P,3PN & 4P variants
- Suitable for isolation as per IS/IEC 60947-3
- Unique positive off indication
- Suitable for AC23A Duty @ 690V AC, 50Hz

- Roller contacts with high operating life
- IP65 handle with door interlock
- Wide range of accessories
- Suitable for power distribution as well as motor protection



## Switch disconnector fuse: 3KL8 4-pole, for power distribution (in Open Execution)

Rated current I <sub>e</sub> @690V 50Hz	SDF suitable for DIN type HRC fuses	Unit MRP* ₹	SDF suitable for BS type HRC fuses	Unit MRP* ₹	SDF suitable for Cylindrical type HRC fuses	Unit MRP* ₹	Std. pkg. (nos.)
20A	3KL8111-4TA00	3340.-	3KL8111-4TJ00	3395.-	3KL8111-4TC00	3465.-	1
32A	3KL8121-4TA00	3455.-	3KL8121-4TJ00	3720.-	3KL8121-4TC00	3745.-	1
63A	3KL8151-4TA00	4650.-	3KL8151-4TJ00	4715.-	3KL8151-4TC00	4910.-	1
100A	3KL8171-4TA00	6980.-	-	-	-	-	1
100A	3KL8211-4TA00	10025.-	3KL8211-4TJ00	10935.-	-	-	1
125A	3KL8221-4TA00	12290.-	3KL8221-4TJ00	13020.-	-	-	1
160A	3KL8231-4TA00	13640.-	3KL8231-4TJ00	15820.-	-	-	1
200A	3KL8311-4UA00	19570.-	3KL8311-4UJ00	20545.-	-	-	1
250A	3KL8321-4UA00	22805.-	3KL8321-4UJ00	24350.-	-	-	1
315A	3KL8331-4UA00	27450.-	3KL8331-4UJ00	30045.-	-	-	1
400A	3KL8341-4UA00	30205.-	3KL8341-4UJ00	34710.-	-	-	1
500A	3KL8411-4UA00	49050.-	3KL8411-4UJ00	55950.-	-	-	1
630A	3KL8421-4UA00	50855.-	3KL8421-4UJ00	57975.-	-	-	1
800A <sup>§</sup>	3KL8431-4UA00	60110.-	3KL8431-4UJ00	62815.-	-	-	1

## Switch disconnector fuse:3KL8 3PN for power distribution and motor protection (Open Execution)

Rated current I <sub>e</sub> @690V 50Hz	SDF suitable for DIN type HRC fuses	Unit MRP* ₹	SDF suitable for BS type HRC fuses	Unit MRP* ₹	SDF suitable for Cylindrical type HRC fuses	Unit MRP* ₹	Std. pkg. (nos.)
20A	3KL8111-5TA00	2965.-	3KL8111-5TJ00	2975.-	3KL8111-5TC00	2985.-	1
32A	3KL8121-5TA00	3015.-	3KL8121-5TJ00	3030.-	3KL8121-5TC00	3055.-	1
63A	3KL8151-5TA00	4045.-	3KL8151-5TJ00	4125.-	3KL8151-5TC00	4165.-	1
100A	3KL8171-5TA00	5790.-	-	-	-	-	1
100A	3KL8211-5TA00	8060.-	3KL8211-5TJ00	8135.-	-	-	1
125A	3KL8221-5TA00	10375.-	3KL8221-5TJ00	10425.-	-	-	1
160A	3KL8231-5TA00	11110.-	3KL8231-5TJ00	11160.-	-	-	1
200A	3KL8311-5UA00	15245.-	3KL8311-5UJ00	15705.-	-	-	1
250A	3KL8321-5UA00	17315.-	3KL8321-5UJ00	17790.-	-	-	1
315A	3KL8331-5UA00	20620.-	3KL8331-5UJ00	20960.-	-	-	1
400A	3KL8341-5UA00	24850.-	3KL8341-5UJ00	25215.-	-	-	1
500A	3KL8411-5UA00	39965.-	3KL8411-5UJ00	40885.-	-	-	1
630A	3KL8421-5UA00	42095.-	3KL8421-5UJ00	44280.-	-	-	1
800A <sup>§</sup>	3KL8431-5UA00	44885.-	3KL8431-5UJ00	47980.-	-	-	1

## Switch disconnector fuse: 3KL8 3-pole, for motor protection (in Open Execution)

Rated current I <sub>e</sub> @ 690V 50Hz	SDF suitable for DIN type HRC Fuses	Unit MRP* ₹	Std. pkg. (nos.)
20A	3KL8111-1TA00	2875.-	1
32A	3KL8121-1TA00	2935.-	1
63A	3KL8151-1TA00	3975.-	1
100A	3KL8211-1TA00	7920.-	1
125A	3KL8221-1TA00	10070.-	1
160A	3KL8231-1TA00	10885.-	1
200A	3KL8311-1UA00	14770.-	1
250A	3KL8321-1UA00	17220.-	1
315A	3KL8331-1UA00	20310.-	1
400A	3KL8341-1UA00	24455.-	1
500A	3KL8411-1UA00	39355.-	1
630A	3KL8421-1UA00	41830.-	1
800A <sup>§</sup>	3KL8431-1UA00	44610.-	1

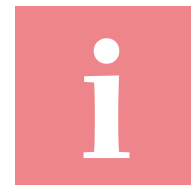

§ 3KL8431 (800A): 710A with fuse cover

Notes:

2P = 2-pole; 3P = 3-pole; 3PN = 3-pole with neutral link; 4P = 4-pole

3KL8: Unit MRPs are without fuses

3KL8: Unit MRPs are inclusive of Front drive (Handle) and phase barriers

Please scan the QR code for brochure and Operation manual (OM)

Refer the OM for changes in dimension

Std. Pkg. = 1 unit

\* MRP - Maximum Retail Price

# Superswitch 3KL8

## Switch disconnecter fuse: 3KL8 2-pole (Open Execution)

Rated current I <sub>e</sub> @690V 50Hz	SDF suitable for DIN type HRC fuses	Unit MRP* ₹	SDF suitable for BS type HRC fuses	Unit MRP* ₹	SDF suitable for Cylindrical type HRC fuses	Unit MRP* ₹	Std. pkg. (nos.)
20A <sup>®</sup>	3KL8111-2TA00	2685.-	-	-	3KL8111-2TC00	2730.-	1
32A <sup>®</sup>	3KL8121-2TA00	2730.-	-	-	3KL8121-2TC00	2855.-	1
63A <sup>®</sup>	3KL8151-2TA00	3555.-	-	-	3KL8151-2TC00	3590.-	1
100A <sup>®</sup>	3KL8171-2TA00	5500.-	-	-	-	-	1
100A	3KL8211-2TA00	7575.-	3KL8211-2TJ00	7745.-	-	-	1
125A	3KL8221-2TA00	8775.-	3KL8221-2TJ00	9560.-	-	-	1
160A	3KL8231-2TA00	9125.-	3KL8231-2TJ00	10295.-	-	-	1
200A	3KL8311-2UA00	13265.-	3KL8311-2UJ00	14500.-	-	-	1
250A	3KL8321-2UA00	14450.-	3KL8321-2UJ00	16010.-	-	-	1
315A	3KL8331-2UA00	17575.-	3KL8331-2UJ00	18650.-	-	-	1
400A	3KL8341-2UA00	20950.-	3KL8341-2UJ00	22020.-	-	-	1
500A	3KL8411-2UA00	33070.-	3KL8411-2UJ00	38505.-	-	-	1
630A	3KL8421-2UA00	33830.-	3KL8421-2UJ00	39070.-	-	-	1
800A <sup>§</sup>	3KL8431-2UA00	44005.-	3KL8431-2UJ00	44145.-	-	-	1



## Switch disconnecter fuse in SS<sup>^</sup> Enclosure (factory fitted)<sup>1)</sup>

Rated current I <sub>e</sub> @690V 50Hz	Suitable fuse type	3PN	Unit MRP* ₹	4P	Unit MRP* ₹	Std. pkg. (nos.)
20A	DIN	3KL8111-5TA10	6200.-	3KL8111-4TA10	7145.-	1
	BS	3KL8111-5TJ10	6250.-	3KL8111-4TJ10	7160.-	1
	CYL	3KL8111-5TC10	6290.-	3KL8111-4TC10	7220.-	1
32A	DIN	3KL8121-5TA10	6630.-	3KL8121-4TA10	7370.-	1
	BS	3KL8121-5TJ10	6650.-	3KL8121-4TJ10	7455.-	1
	CYL	3KL8121-5TC10	6685.-	3KL8121-4TC10	7480.-	1
63A	DIN	3KL8151-5TA10	7365.-	3KL8151-4TA10	8690.-	1
	BS	3KL8151-5TJ10	7390.-	3KL8151-4TJ10	8910.-	1
	CYL	3KL8151-5TC10	7450.-	3KL8151-4TC10	8940.-	1
100A	DIN	3KL8211-5TA10	11805.-	3KL8211-4TA10	14000.-	1
	BS	3KL8211-5TJ10	12150.-	3KL8211-4TJ10	14135.-	1
125A	DIN	3KL8221-5TA10	13995.-	3KL8221-4TA10	16860.-	1
	BS	3KL8221-5TJ10	14100.-	3KL8221-4TJ10	17390.-	1
160A	DIN	3KL8231-5TA10	15015.-	3KL8231-4TA10	18535.-	1
	BS	3KL8231-5TJ10	15130.-	3KL8231-4TJ10	18655.-	1
200A	DIN	3KL8311-5UA10	21650.-	3KL8311-4UA10	30255.-	1
	BS	3KL8311-5UJ10	21815.-	3KL8311-4UJ10	30950.-	1
250A	DIN	3KL8321-5UA10	24545.-	3KL8321-4UA10	32215.-	1
	BS	3KL8321-5UJ10	24715.-	3KL8321-4UJ10	32440.-	1
315A	DIN	3KL8331-5UA10	29200.-	3KL8331-4UA10	38345.-	1
	BS	3KL8331-5UJ10	29360.-	3KL8331-4UJ10	38540.-	1
400A	DIN	3KL8341-5UA10	33680.-	3KL8341-4UA10	42995.-	1
	BS	3KL8341-5UJ10	34110.-	3KL8341-4UJ10	43180.-	1
500A	DIN	3KL8411-5UA10	50150.-	3KL8411-4UA10	63235.-	1
	BS	3KL8411-5UJ10	50300.-	3KL8411-4UJ10	63920.-	1
630A	DIN	3KL8421-5UA10	52795.-	3KL8421-4UA10	67150.-	1
	BS	3KL8421-5UJ10	52950.-	3KL8421-4UJ10	67350.-	1
800A <sup>§</sup>	DIN	3KL8431-5UA10	56680.-	3KL8431-4UA10	72095.-	1
	BS	3KL8431-5UJ10	56825.-	3KL8431-4UJ10	72285.-	1



## SS<sup>^</sup> Enclosure for 3KL8/ 3KA8

Rated current I <sub>e</sub> @690V 50Hz	Enclosure type	Unit MRP* ₹	Std. pkg. (nos.)
20A-160A	3KX8235-4AC	4385.-	1
200A-400A	3KX8345-4AC	5835.-	1
500A-800A	3KX8435-4AC <sup>1)</sup>	9565.-	1
200A-800A	3KX8435-4AG #2) <b>NEW</b>	16430.-	1

@ In 3P housing

^ SS stands for Sheet Steel

1) 3KL8 in SS Enclosure: Includes 3KL8 SDF without fuses, SS Enclosure, front drive (Handle) and phase barriers

\$ 3KL8431 (800A): 710A with fuse cover

^ SS stands for Sheet Steel

# Enclosure for 4-pole SDF / SD type 3KL83/4 & 3KA83/4

1) SD (except 4-pole) type 3KA84 (630A-1600A), recommended to be used along with gland box 3KX84354DC (2nos.)

2) SD (4-pole only) type 3KA84 (630A-1600A), recommended to be used along with gland box 3KX84354DG (2nos.)

Std. Pkg. = 1 unit \* MRP - Maximum Retail Price

Notes:

2P = 2-pole; 3P = 3-pole; 3PN = 3-pole with neutral link; 4P = 4-pole

3KL8: Unit MRPs are without fuses

3KL8: Unit MRPs are inclusive of Front drive (Handle) and phase barriers

Refer the brochure for fuse selection guide

Refer the OM for changes in dimension

# Superswitch 3KA8



## Switch Disconnecter: 3KA8 for power distribution (in Open Execution)

Rated current I <sub>n</sub> @690V 50Hz	2P	Unit MRP* ₹	3PN	Unit MRP* ₹	4P	Unit MRP* ₹	Std. pkg. (nos.)
63A	3KA8151-2TE00 <sup>9</sup>	3010.-	3KA8151-5TE00	3625.-	3KA8151-4TE00	5160.-	1
100A	-	-	3KA8171-5TE00	5645.-	3KA8171-4TE00	10380.-	1
100A	3KA8211-2TE00	5270.-	3KA8211-5TE00	7180.-	3KA8211-4TE00	12005.-	1
125A	3KA8221-2TE00	6615.-	3KA8221-5TE00	8240.-	3KA8221-4TE00	12895.-	1
160A	3KA8231-2TE00	8810.-	3KA8231-5TE00	10725.-	3KA8231-4TE00	16245.-	1
200A	3KA8311-2UE00	11205.-	3KA8311-5UE00	13850.-	3KA8311-4UE00	18855.-	1
250A	3KA8321-2UE00	12260.-	3KA8321-5UE00	14625.-	3KA8321-4UE00	23160.-	1
400A	3KA8341-2UE00	17010.-	3KA8341-5UE00	21625.-	3KA8341-4UE00	31565.-	1
630A <sup>5</sup>	3KA842□-2UE00	27280.-	3KA842□-5UE00	34325.-	3KA842□-4UE00	45190.-	1
800A <sup>5</sup>	3KA843□-2UE00	28465.-	3KA843□-5UE00	35425.-	3KA843□-4UE00	51855.-	1
1000A <sup>5</sup>	3KA844□-2UE00	38090.-	3KA844□-5UE00	50885.-	3KA844□-4UE00	63900.-	1
1250A <sup>5</sup>	3KA845□-2UE00	50085.-	3KA845□-5UE00	66010.-	3KA845□-4UE00	76820.-	1
1600A <sup>5</sup>	3KA846□-2UE00	57765.-	3KA846□-5UE00	73060.-	3KA846□-4UE00	103460.-	1

□ - 2: Top Incoming  
□ - 3: Bottom Incoming

@ In 3P housing

\$ Utilization category AC21A @690V AC (1600A: @500V AC)

Notes:

2P = 2-pole; 3P = 3-pole; 3PN = 3-pole with neutral link; 4P = 4-pole

3KA8: Unit MRPs are inclusive of Front drive (Handle)

Please scan the QR code for Catalog and Operating instruction sheets (OIS)

Refer the OIS for changes in dimension

## Accessories for Superswitch 3KL8 / 3KA8

Description	Pole	Fuse type	3KL81 11/21/51/71 3KA81 51/71	Unit MRP* ₹	3KL82 11/21/31 3KA82 11/21/31	Unit MRP* ₹	3KL83 11/21/31/41 3KA83 11/21/41	Unit MRP* ₹	3KL84 11/21/31 3KA84 2/3/4/5/6	Unit MRP* ₹	Std. pkg. (nos.)				
Fuse cover <sup>2)</sup>	2P	DIN	3KX8150-0AE <sup>5)</sup>	290.-	3KX8230-0JF	700.-	3KX8340-0AF	1025.-	3KX8430-0JF	1450.-	1				
		BS			3KX8230-0HF	700.-			3KX8430-0HF	1450.-	1				
	3P	DIN			3KX8230-0JE	700.-			3KX8340-0AE	1025.-	3KX8430-0JE	1450.-	1		
		BS			3KX8230-0HE	700.-					3KX8430-0HE	1450.-	1		
	4P	DIN			3KX8230-0JG	700.-					3KX8340-0AG	1025.-	3KX8430-0JG	1450.-	1
		BS			3KX8230-0HG	700.-							3KX8430-0HG	1450.-	1
Terminal cover (1set = 2pieces)	2P	-	3KX8151-0AE	140.-	3KX8231-0AF	590.-	3KX8341-0AF	1120.-					3KX8431-0AF	1310.-	1
	3P	-			3KX8231-0AE	590.-							3KX8341-0AE	1120.-	3KX8431-0AE
	4P	-			3KX8231-0AG	590.-			3KX8341-0AG	1120.-			3KX8431-0AG	1310.-	1
Phase barrier	-	DIN/ BS/ Cylindrical	3KX8153-0AE	55.-	3KX8153-0AE (DIN)	55.-	3KX8343-0AE	180.-	3KX8433-0AE	270.-			1		
					3KX8233-0JE (BS)	55.-					1				
Fuse cover phase barrier kit <sup>3)</sup>	-	-	-	-	-	-	3KX8340-9AE	570.-	3KX8440-9AE	570.-	1				
Auxiliary switch (1NO+1NC)	-	-	3SB5400-0A <sup>4)</sup>	230.-	3KX3522-1YC	900.-	3KX3552-1YC	1085.-	3KX3582-1YC	1310.-	1				
Auxiliary switch (2NO+2NC)	-	-	-	-	3KX3522-1YD	1625.-	3KX3552-1YD	2350.-	3KX3582-1YD	2540.-	1				
Auxiliary switch cover	-	-	3KX8154-0AC	100.-	3KX8234-0AC	100.-	-	-	-	-	1				
Front drive (Handle)	-	-	8UC6114-1BB00	1135.-	8UC6214-1BB00	1285.-	8UC6314-1BB00	1940.-	8UC6414-1BB00	2830.-	1				
Operating shaft (300mm)	-	-	8UC60-31	315.-	8UC60-32	380.-	8UC60-34	735.-	8UC60-34	735.-	1				
Castell interlock <sup>1)</sup>	-	-	8UC6070-0YQ..	5925.-	8UC6070-1YQ..	5925.-	8UC6070-2YQ..	6085.-	8UC6070-2YQ..	6085.-	1				
Depth setting template	-	-	8UC6046-2	60.-	8UC6046-2	60.-	8UC6046-2	60.-	8UC6046-2	60.-	1				
Fuse Monitor with auxiliary switch <sup>4)</sup> (1NO+1NC)	-	-	3RV1611-0BD10	9410.-	3RV1611-0BD10	9410.-	3RV1611-0BD10	9410.-	3RV1611-0BD10	9410.-	1				
	-	-	3RV2901-1E	1225.-	3RV2901-1E	1225.-	3RV2901-1E	1225.-	3RV2901-1E	1225.-	1				
Fuse safety barrier	-	-	3KX8150-1AC	150.-	3KX8230-1AC	200.-	-	-	-	-	1				
Gland box with gland plate (1no.)	-	-	3KX8235-4DC	5085.-	3KX8235-4DC	5085.-	3KX8345-4DC	7020.-	3KX8435-4DC	10695.-	1				
	-	-	-	-	-	-	-	-	3KX8435-4DG <sup>4)</sup>	17500.-	1				
Gland plate	-	-	3KX8235-4GC	1075.-	3KX8235-4GC	1075.-	3KX8345-4GC	1400.-	3KX8435-4GC	1550.-	1				
	-	-	-	-	-	-	-	-	3KX8435-4GG <sup>4)</sup>	1570.-	1				

1) The 11th and 12th place of the type reference will indicate the alphabet type of lock & key. Combinations available are A, B, C, D, A-, -B, -C, AB, AC. 11th place will be A, B, C, D for castell lock type A, B, C, D respectively. 11th and 12 place will be A0, 0B, 0C, AB, AC for castell lock type A-, -B, -C, AB, AC respectively.

2) Additionally order: Phase barrier 2nos. with Fuse cover for 20A-160A SDF and "Fuse cover phase barrier kit" with Fuse cover for 200A - 800A SDF

3) Mandatory accessory to be ordered with fuse cover for 200A - 800A SDF

4) Accessory for 4-pole SDF with enclosure type 3KL83 & 3KL84 and SS enclosure type 3KX8435-4AG

5) Also, suitable for SDF with cylindrical type HRC fuses

Note: The above accessories e.g. Fuse Cover, Terminal Cover, Phase barrier, Fuse cover phase barrier kit & Front Drive (handle) are unique (different) and not to be used along with MLFB 3KL8...-3.A00, 3KL8...-3.J00, 3KL8...-3.C00

Std. Pkg. = 1 unit

\* MRP - Maximum Retail Price

^ - List Price

# - Std. pkg. = 10

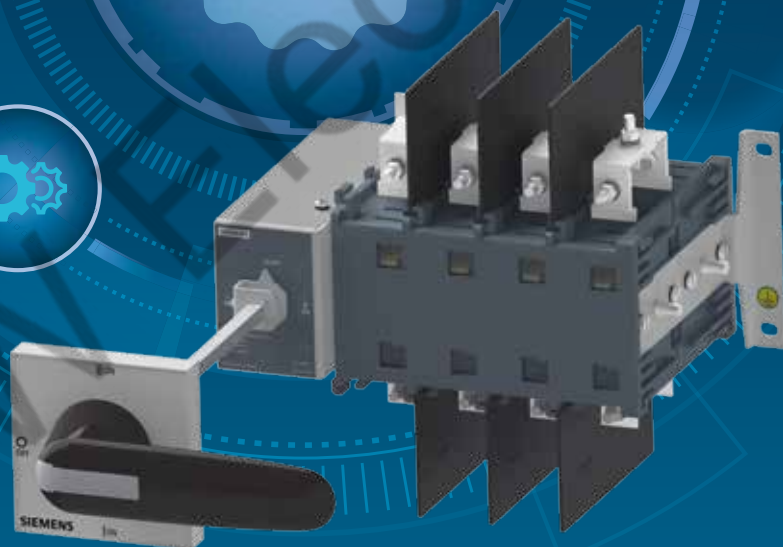

**SINOVA**

# On Load Changeover Switches – 3KJ

## Simply Efficient

- Compliant with IS/IEC60947-3
- 4-pole modular switches up to 3150A in open and enclosed versions
- Stable I-O-II positions with safe switching
- Suitable for Positive isolation
- Built-in bridging bars and phase barriers
- Wide portfolio of accessories and spares

[www.siemens.co.in](http://www.siemens.co.in)

**SIEMENS**



## Manual On Load Changeover Switch 3KJ

- 63A to 3150A in 4-pole configuration
- Open and Enclosed execution
- Comply to IS/IEC 60947-3
- Suitable for Positive isolation
- Available in AC-21 / AC-22 / AC-23 @415V 50/60Hz
- Wide portfolio of accessories and spares
- Built-in bridging bars and phase barriers
- Suitable terminals and metallic handles 1000A onwards
- Stable I-O-II positions with safe switching
- Modular range for rating 125A to 3150A

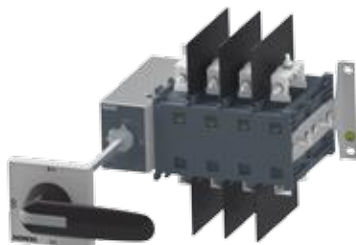

### Manual On Load Changeover Switch 3KJ 4-pole, for power distribution

Series	Size	Rated current Ie @415V 50/60Hz	MCOS in Open execution	Unit MRP* ₹	MCOS in Enclosed execution	Unit MRP* ₹	Std. pkg. (nos.)
3KJ1#	1	63	3KJ1126-4AA20-0AA0	6775.-	3KJ1126-4AA20-1AA0	13400.-	1
		100	3KJ1130-4AA20-0AA0	9015.-	3KJ1130-4AA20-1AA0	15745.-	1
3KJ0	1	125	3KJ0132-4AA20-0AA0	13495.-	3KJ0132-4AA20-1AA0	18345.-	1
		160	3KJ0134-4AA20-0AA0	14830.-	3KJ0134-4AA20-1AA0	21005.-	1
	2	200	3KJ0236-4AA20-0AA0	18890.-	3KJ0236-4AA20-1AA0	24300.-	1
		250	3KJ0238-4AA20-0AA0	23110.-	3KJ0238-4AA20-1AA0	30195.-	1
		315	3KJ0240-4AA20-0AA0	30280.-	3KJ0240-4AA20-1AA0	36910.-	1
		400	3KJ0242-4AA20-0AA0	43955.-	3KJ0242-4AA20-1AA0	54870.-	1
	3	630	3KJ0346-4AA20-0AA0	52275.-	3KJ0346-4AA20-1AA0	63175.-	1
		800	3KJ0348-4AA20-0AA0	75825.-	3KJ0348-4AA20-1AA0	90860.-	1
	4	1000	3KJ0450-4AA30-0AA0	142805.-	3KJ0450-4AA30-1AA0	157040.-	1
		1250	3KJ0452-4AA30-0AA0	175995.-	3KJ0452-4AA30-1AA0	202815.-	1
		1600	3KJ0454-4AA30-0AA0	224360.-	3KJ0454-4AA30-1AA0	273530.-	1
	5	2000	3KJ0556-4AA30-0AA0	345380.-	3KJ0556-4AA30-1AA0	377015.-	1
		2500	3KJ0558-4AA30-0AA0	442810.-	3KJ0558-4AA30-1AA0	482415.-	1
		3150	3KJ0560-4AA30-0AA0	569375.-	3KJ0560-4AA30-1AA0	653895.-	1

#### Notes:

3KJ On Load Changeover Switch is switch disconnecter type

3KJ: Unit MRPs are inclusive of Front drive (Handle), shaft, phase barriers and bridging bars

# Non-Modular construction

POR: Price On Request

Refer the operating instruction sheet for complete dimensional details

Std. Pkg. = 1 unit

\* MRP - Max. Retail Price

# Manual On Load Changeover Switch 3KJ

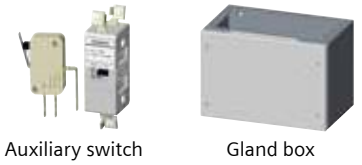

## Accessories and spares

Accessory	Description	3KJ11	Unit MRP* ₹	3KJ01	Unit MRP* ₹	3KJ02	Unit MRP* ₹	Std.pkg. (nos.)
Auxiliary switch <sup>1)</sup>	1CO	3KJ9101-1AB00	680.-					1
	2CO	3KJ9101-1AD00	1355.-					1
	1NO+1NC			3KJ9001-1AB00	1755.-	3KJ9001-5AB00	3560.-	1
	2NO+2NC			3KJ9001-1AD00	6125.-	3KJ9001-5AD00	13300.-	1
Gland box <sup>2)</sup>	With one gland plate			3KJ9013-1MA00	3655.-	3KJ9013-2MB00	8265.-	1
Spare Phase barrier		3KJ9103-1CA00	45.-	3KJ9003-1CA00	65.-	3KJ9003-3CA00	100.-	1
Spare Front drive (Handle)	Plastic	3KJ9106-1FT00	640.-	3KJ9006-2FT00	640.-	3KJ9006-2FT00	640.-	1
Spare Shaft		3KJ9107-1GA00	215.-	3KJ9007-2GA00	215.-	3KJ9007-2GA00	215.-	1
Spare pole <sup>3)</sup>				125A 3KJ9008-1HC00	POR	200A 3KJ9008-2HE00	POR	1
				160A 3KJ9008-1HD00		250A 3KJ9008-2HF00		1
					315A 3KJ9008-2HG00	1		
					400A 3KJ9008-2HH00	1		
						400A 3KJ9008-2HE00		1
Spare Bridging bar	Load side connection	63A,100A 3KJ9102-1BA00	POR	125A,160A 3KJ9002-1BB00	POR	200A 3KJ9002-2BC00	POR	1
						250A,315A 3KJ9002-2BD00	POR	1
						400A 3KJ9002-2BE00	POR	1
								1

Accessory	Description	3KJ03	Unit MRP* ₹	3KJ04	Unit MRP* ₹	3KJ05	Unit MRP* ₹	Std.pkg. (nos.)
Auxiliary Switch <sup>1)</sup>	1NO+1NC	3KJ9001-5AB00	3560.-	3KJ9001-5AB00	3560.-	3KJ9001-5AB00	3560.-	1
	2NO+2NC	3KJ9001-5AD00	13300.-	3KJ9001-5AD00	13300.-	3KJ9001-5AD00	13300.-	1
Gland box <sup>2)</sup>	With one gland plate	3KJ9013-3MC00	12720.-					1
Spare Phase barrier	Lower side	3KJ9003-3CA00	100.-	3KJ9003-4CA00	360.-			1
	Front side					3KJ9003-5CA10	360.-	1
						3KJ9003-5CA20	390.-	1
Spare Front drive (Handle)	Plastic	3KJ9006-3FT00	730.-					1
	Metallic			3KJ9006-4FM00	2110.-	3KJ9006-5FM00	2265.-	1
Spare Shaft		3KJ9007-4GA00	460.-	3KJ9007-4GA00	460.-	3KJ9007-5GA00	460.-	1
Spare pole <sup>3)</sup>		1000A 3KJ9008-3HJ00	POR	1000A 3KJ9008-4HL00	POR	2000A 3KJ9008-4HL00	POR	1
		800A 3KJ9008-3HK00		1250A 3KJ9008-4HM00		2500A 3KJ9008-4HM00		1
			1600A 3KJ9008-4HN00	3150A 3KJ9008-4HN00		1		
						1		
Spare Extended link				1000A 3KJ9012-4LA00	POR			1
				1250A 3KJ9012-4LB00		1		
				1600A 3KJ9012-4LC00		1		
						1		
Spare Bridging bar	Load side connection	630A 3KJ9002-3BF00	POR	1000A 3KJ9002-4BH00	POR			1
		800A 3KJ9002-3BG00		1250A 3KJ9002-4BJ00		2000A 3KJ9002-5BL20 3KJ9002-5BL30	1	
			1600A 3KJ9002-4BK10 3KJ9002-4BK20	2500A 3KJ9002-5BM20 3KJ9002-5BM30		1		
				3150A 3KJ9002-5BN30 3KJ9002-5BN40 3KJ9002-5BN50		POR	1	
	Line side connection					2000A 3KJ9002-5BL10		1
						2500A 3KJ9002-5BM10		1
						3150A 3KJ9002-5BN10 3KJ9002-5BN20		1
								1

Notes:  
 1) Accessory - Auxiliary switch includes 2units. One each for position I and II  
 2) Accessory - Gland box is to be used with enclosed switches  
 3) Spare pole: For ratings 2000A, 2500A and 3150A. Use 2units of 1000A, 1250A and 1600A  
 POR: Price On Request

Std. Pkg. = 1 unit

\* MRP - Max. Retail Price

Load Break Switches



SIVACON

Technology  
Partner

SIEMENS

# When it comes to safety, nothing beats SIVACON

**SIVACON S8 - the only most economical switchboard  
with true closed door trolley disconnection**

The SIVACON S8 low-voltage power distribution switchboard sets new standards of fail-proof safety & service. In conformance to the IEC 61439-1&2, SIVACON S8 guarantees high performance, maximum safety and compact modularity.

## Features

- The only 'Arc Free' switchboards in the world
- SIVACON patented double front PCCs upto 7000A, 150kA
- Patented holeless technology for connections
- Patented ventilation technique
- Combination of fixed, plugin & drawout feeders in the same vertical
- State-of-the-art technology, innovation in design and unmatched performance

[www.siemens.com/sivacon-details](http://www.siemens.com/sivacon-details)

**SIEMENS**

## Main control and EMERGENCY STOP switches 3LD2

- Rated current range: 16A-250A
- Conforms to IEC 60947-3 / UL508
- Can be used for motor & power distribution application



### Main and EMERGENCY-STOP switches with rotary operating mechanism

Front mounting - Four hole mounting  
Lockable in OFF position with upto 3 padlocks,  
Degree of Protection IP65



No of Poles	Rated current (A) Ie AC21A	Motor KW AC 23A, 380....440V, 50/60Hz	Type	Unit LP* ₹
3	16	7.5	3LD2003-0TK5□	3290.-
	25	9.5	3LD2103-0TK5□	3635.-
	32	11.5	3LD2203-0TK5□	4055.-
	63	22	3LD2504-0TK5□	6945.-
	100	37	3LD2704-0TK5□	10525.-
	125	45	3LD2804-0TK5□	13415.-
	160	75	3LD2305-0TK1□	POR
	250	132	3LD2405-0TK1□	POR

□ - 1: Black OR  
□ - 3: Red/yellow

### Main control and EMERGENCY-STOP switches with selector switch operating mechanism

Front mounting - Four hole mounting  
Lockable in OFF position with upto 2 padlocks,  
Degree of Protection IP65,  
Including terminal cover for incoming side



No of Poles	Rated current (A) Ie AC21A	Motor KW AC 23A, 380....440V, 50/60Hz	Type	Unit LP* ₹
3	16	7.5	3LD2022-0TK1□	2935.-
	25	9.5	3LD2122-0TK1□	3220.-
	32	11.5	3LD2222-0TK1□	3905.-

□ - 1: Black OR  
□ - 3: Red/yellow

### Changeover switches with selector switch operating mechanism

Front mounting - Four hole mounting  
Selector switch cannot be locked  
Degree of Protection IP65  
Black Actuator



No of Poles	Rated current (A) Ie AC21A	Motor KW AC 23A, 380....440V, 50/60Hz	Type	Unit LP* ₹
3	25	9.5	3LD2123-7UK01	7205.-
	32	11.5	3LD2223-7UK01	7880.-
	63	22	3LD2524-7UK01	13035.-
	100	37	3LD2724-7UK01	24235.-
	160	75	3LD2305-7UK01	POR
	250	132	3LD2405-7UK01	POR

### Changeover switch with knob Operated Mechanism In moulded plastic enclosure



No of Poles	Rated current (A) Ie AC21A	Motor KW AC 23A, 380....440V, 50/60Hz	Type	Unit LP* ₹
3	25	9.5	3LD21657UB01	11535.-
	32	11.5	3LD22657UB01	13110.-
	63	22	3LD25667UB01	28440.-
	100	37	3LD27667UB01	49005.-

### Main and EMERGENCY-STOP switches with door coupling rotary operating mechanism

Panel mounting with 300mm switch shaft -  
Four hole mounting  
Lockable in OFF position with upto 3 padlocks,  
Degree of Protection IP65  
Including terminal cover for incoming side



No of Poles	Rated current (A) Ie AC21A	Motor KW AC 23A, 380....440V, 50/60Hz	Type	Unit LP* ₹
3	16	7.5	3LD2013-0TK5□	5270.-
	25	9.5	3LD2113-0TK5□	5850.-
	32	11.5	3LD2213-0TK5□	6450.-
	63	22	3LD2514-0TK5□	7735.-
	100	37	3LD2714-0TK5□	12705.-
	125	45	3LD2814-0TK5□	15870.-
	160	75	3LD2318-0TK1□	POR
	250	132	3LD2418-0TK1□	POR

□ - 1: Black OR  
□ - 3: Red/yellow

### Main control and EMERGENCY-STOP switches In Moulded plastic enclosures

Lockable in OFF position with upto 3 padlocks,  
Degree of Protection IP65,  
with centre hole mounting  
with N and/or PE ground terminals



No of Poles	Rated current (A) Ie AC21A	Motor KW AC 23A, 380....440V, 50/60Hz	Type	Unit LP* ₹
3	16	7.5	3LD2064-0TB5□	4685.-
	25	9.5	3LD2164-0TB5□	5080.-
	32	11.5	3LD2264-0TB5□	6040.-
	63	22	3LD2565-0TB5□	10000.-
	100	37	3LD2766-0TB5□	22725.-
	125	45	3LD2866-0TB5□	41130.-

□ - 1: Black OR  
□ - 3: Red/yellow

Note: 3LD23/24 knob operated mechanism

POR: Price On Request

Std. Pkg. = 1 unit \* LP - List Price

#### Configurator for 3LD

- Ready-to-install version
- Application specific switches
- Accessories



## Accessories for 3LD2

Mounting	Description	For Switch	Type	Unit LP* ₹	Std. pkg. (nos.)		
For front mounting switch	Add on switched 4th pole (N Conductor Leading switch ON, delayed switch OFF)	3LD21 (25A) and 3LD22 (32A)	3LD9220-0B	1480.-	1		
		3LD25 (63A)	3LD9250-0BA	2175.-	1		
		3LD27 (100A) and 3LD28 (125A)	3LD9280-0B	2700.-	1		
		3LD23 (160A) and 3LD24 (250A)	3LD9240-0B	POR	1		
	N or PE terminal Continuous	3LD20 (16A)	3LD9200-2B	990.-	1		
		3LD21 (25A) and 3LD22 (32A)	3LD9220-2B	1130.-	1		
		3LD25 (63A)	3LD9250-2BA	1485.-	1		
		3LD27 (100A) and 3LD28 (125A)	3LD9280-2B	1805.-	1		
	Auxiliary switches For mounting on left and/or right 1NO+1NC	3LD23 (160A) and 3LD24 (250A)	3LD9240-2B	POR	1		
		3LD20, 3LD21, 3LD22, 3LD25, 3LD27, 3LD28, 3LD23 and 3LD24	3LD9200-5B	1645.-	1		
		For floor and distribution board mounting switch or 3LD2 switch in moulded-plastic enclosure	Add on switched 4th pole (N Conductor Leading switch ON, delayed switch OFF)	3LD21 (25A) and 3LD22 (32A)	3LD9220-0C	1480.-	1
				3LD25 (63A)	3LD9250-0CA	2175.-	1
3LD27 (100A) and 3LD28 (125A)	3LD9280-0C			2700.-	1		
3LD23 (160A) and 3LD24 (250A)	3LD9240-0C			POR	1		
N or PE terminal Continuous	3LD20 (16A)		3LD9200-2C	1340.-	1		
	3LD21 (25A) and 3LD22 (32A)		3LD9220-2C	1130.-	1		
	3LD25 (63A)		3LD9250-2CA	1485.-	1		
	3LD27 (100A) and 3LD28 (125A)		3LD9280-2C	1805.-	1		
Auxiliary switches For mounting on left and/or right 1NO+1NC	3LD23 (160A) and 3LD24 (250A)		3LD9240-2C	POR	1		
	3LD20, 3LD21, 3LD22, 3LD25, 3LD27, 3LD28, 3LD23 and 3LD24		3LD9200-5C	1560.-	1		
	Terminal cover for touch protection can be snapped on at top & bottom for front, floor and distribution board mounting		4 pole	3LD20 (16A)	3LD9201-1A	505.-	4
			3 pole	3LD21 (25A) and 3LD22 (32A)	3LD9221-0A	470.-	4
3 pole		3LD25 (63A)	3LD9251-0A	525.-	4		
1 pole		3LD27 (100A) and 3LD28 (125A)	3LD9281-2A	255.-	4		
1 pole		3LD23 (160A) and 3LD24 (250A)	3LD9241-2A	POR	4		
For front (four hole mounting only) and floor mounting switch or 3LD2 switch in moulded-plastic enclosure	Auxiliary switch, front-mounted, for long leading times 1NO+1NC, lagging switch-on, leading switch-off (20 ms to 150 ms)	3LD20, 3LD21, 3LD22, 3LD25, 3LD27 and 3LD28	3LD9280-5D	POR	1		
		3LD23 and 3LD24	3LD9240-5D	POR	1		

3LD2 maintenance and repair switches with EMC shield plate.  
Please contact your nearest Siemens partner for further details.



## Motor control switches 3LA0

Description	Motor output 415V, 50Hz, 3Ph kW	Type	Unit LP* ₹	Std. pkg. (nos.)	
Open execution	On/Off	7.5	3LA0201-1YA	2730.-	10
		30	3LA0601-1YB	6335.-	5
	System selector	5.5	3LA0202-1YA	3115.-	10
		30	3LA0602-1YB	8860.-	5
	Reversing	5.5	3LA0203-1YA	3115.-	10
		30	3LA0603-1YB	8860.-	5
	Star-delta	12	3LA0204-5YA	4390.-	10
		30	3LA0604-1YB	12060.-	5
	2 speed pole changing i) Separate windings ii) Dahlander	5.5	3LA0205-2YA	3115.-	10
		5.5	3LA0205-1YA	4190.-	10
		5.5	3LA0205-3YA	6025.-	10

## Spares & accessories for motor control switches\*\*



Description	Type	Unit LP* ₹	Std. pkg. (nos.)
Ball handle – Black	3LX0 211-1YA	165.-	10
Machine handle – Black	3LX0 611-2YA	445.-	10
Indicating dial for size 2	3LX0 220-1YA	125.-	10
Indicating dial for size 6	3LX0 620-1YA	125.-	10
Catching lever for the drive mechanism of size 2switch (2 nos. reqd. per switch)	3LY0 220-2YA	125.-	10
Tension spring for the drive mechanism of size 2 switch	3LY0 210-1YA	115.-	10

\*\* All parts supplied loose in polythene bags.

## Heavy duty switches 3LA0

No. of poles	Rated current		Open execution		
	AC 22A	AC 23A	Type	Unit LP* ₹	Std. pkg. (nos.)
2	25	16	3LA0205-4YA	1870.-	10
	63	52	3LA0605-1YB	4495.-	5
4	25	16	3LA0205-5YA	3115.-	10
	63	52	3LA0605-2YB	8195.-	5

POR: Price On Request

\* LP - List Price



## 3LD4

# Control Switches

- Compact and flexible design
- Double break contacts ensures high reliability
- Suitable for ambient temperatures up to 50°C
- Quick and easy installation
- High electrical and mechanical life

[www.siemens.co.in](http://www.siemens.co.in)

**SIEMENS**

## 3LD4 Control Switches

The 3LD4 Control Switches are cam operated switches suitable for use in a wide variety of control and auxiliary circuit applications.

- Conforms to IEC 60947-3, IEC 60947-5
- Range 6A to 100A
- Suitable for AC21A, AC-15 Utilization category
- Suitable for ambient up to 50°C
- Double break contacts for reliable operation
- Terminals designed for easy and fast installation



## ON OFF Switches

### 90° operation

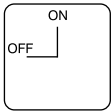

Type#	Description	Unit LP* ₹									Std. pkg. (nos.)
		6A (001)	10A (102)	16A (103)	20A (104)	25A (205)	32A (206)	40A (207)	63A (208)	100A (309)	
3LD4 ___ 1AA00-ORCO	1 Pole	185.-	350.-	420.-	440.-	455.-	565.-	720.-	840.-	4390.-	1
3LD4 ___ 2AA00-ORCO	2 Pole	235.-	400.-	475.-	530.-	550.-	655.-	860.-	1075.-	5485.-	
3LD4 ___ 3AA00-ORCO	3 Pole	255.-	475.-	555.-	605.-	720.-	805.-	1005.-	1445.-	6750.-	
3LD4 ___ 4AA00-ORCO <b>NEW</b>	4 Pole	315.-	515.-	595.-	725.-	885.-	950.-	1150.-	1740.-	7905.-	

### 90° Operation with complete rotation

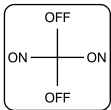

Type#	Description	Unit LP* ₹									Std. pkg. (nos.)
		6A (001)	10A (102)	16A (103)	20A (104)	25A (205)	32A (206)	40A (207)	63A (208)	100A (309)	
3LD4 ___ 1BC00-ORCO	1 Pole	180.-	350.-	420.-	440.-	445.-	555.-	715.-	835.-	4390.-	1
3LD4 ___ 2BC00-ORCO	2 Pole	235.-	400.-	475.-	530.-	550.-	655.-	860.-	1075.-	5485.-	
3LD4 ___ 3BC00-ORCO	3 Pole	255.-	475.-	555.-	605.-	720.-	805.-	1005.-	1445.-	6750.-	
3LD4 ___ 4BC00-ORCO <b>NEW</b>	4 Pole	315.-	515.-	595.-	725.-	885.-	950.-	1150.-	1740.-	7905.-	

\* Fill in the 5th, 6th & 7th of the type nos with the digits in () to get complete MLFB  
e.g. for 6A 3 Pole ON OFF Switch the complete type no will be 3LD40013AA00-ORCO

## Instrumentation Selector Switch

### Ammeter Selector Switch (ASS)

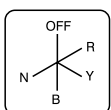
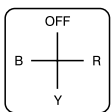

Description	Rating	Type#	Unit LP* ₹	Std. pkg. (nos.)
Line currents with OFF	6A	3LD40014DC200RCO	385.-	1
	10A	3LD41024DC200RCO	460.-	
	16A	3LD41034DC200RCO	590.-	
	20A	3LD41044DC200RCO	660.-	
Line currents with Neutral with OFF	6A	3LD40014DD200RCO	380.-	1
	10A	3LD41024DD200RCO	455.-	
	16A	3LD41034DD200RCO	580.-	
	20A	3LD41044DD200RCO	735.-	



\* LP - List Price

# 3LD4 Control Switches

## Voltmeter Selector Switch (VSS)

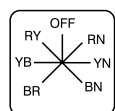
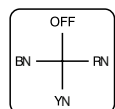
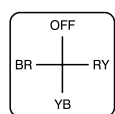

Description	Rating	Type#	Unit LP* ₹	Std. pkg. (nos.)
Line voltages with OFF	6A	3LD40014DC300RC0	280.-	1
	10A	3LD41024DC300RC0	420.-	
	16A	3LD41034DC300RC0	535.-	
	20A	3LD41044DC300RC0	605.-	
Phase voltages with OFF	6A	3LD40014DC310RC0	500.-	
	10A	3LD41024DC310RC0	565.-	
	16A	3LD41034DC310RC0	725.-	
	20A	3LD41044DC310RC0	800.-	
Line & Phase voltages with OFF	6A	3LD40014DF300RC0	500.-	
	10A	3LD41024DF300RC0	840.-	
	16A	3LD41034DF300RC0	1000.-	
	20A	3LD41044DF300RC0	1085.-	



## Changeover Switch

### With OFF (60°)

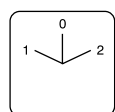

Type#	Description	Unit LP* ₹									Std. pkg. (nos.)
		6A (001)	10A (102)	16A (103)	20A (104)	25A (205)	32A (206)	40A (207)	63A (208)	100A (309)	
3LD4 ___ 1BB10-ORCO	1P 2W	235.-	435.-	530.-	545.-	555.-	615.-	835.-	1135.-	5670.-	1
3LD4 ___ 2BB10-ORCO	2P 2W	315.-	530.-	595.-	705.-	750.-	880.-	1145.-	1715.-	8295.-	
3LD4 ___ 3BB10-ORCO	3P 2W	385.-	655.-	800.-	985.-	1140.-	1230.-	1445.-	2310.-	10740.-	
3LD4 ___ 4BB10-ORCO <b>NEW</b>	4P 2W	475.-	725.-	920.-	1205.-	1515.-	1590.-	1765.-	2920.-	13690.-	



### Without OFF (90°)

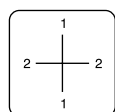

Type#	Description	Unit LP* ₹									Std. pkg. (nos.)
		6A (001)	10A (102)	16A (103)	20A (104)	25A (205)	32A (206)	40A (207)	63A (208)	100A (309)	
3LD4 ___ 1PC10-ORCO	1P 2W	235.-	435.-	530.-	535.-	555.-	615.-	835.-	1135.-	5670.-	1
3LD4 ___ 2PC10-ORCO	2P 2W	315.-	530.-	595.-	705.-	750.-	880.-	1145.-	1715.-	8295.-	
3LD4 ___ 3PC10-ORCO	3P 2W	385.-	655.-	800.-	985.-	1140.-	1230.-	1445.-	2310.-	10740.-	
3LD4 ___ 4PC10-ORCO <b>NEW</b>	4P 2W	475.-	725.-	920.-	1205.-	1515.-	1590.-	1765.-	2920.-	13690.-	

## Phase Changeover Switch (PCS)

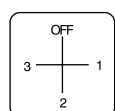

Type#	Description	Unit LP* ₹									Std. pkg. (nos.)
		6A (001)	10A (102)	16A (103)	20A (104)	25A (205)	32A (206)	40A (207)	63A (208)	100A (309)	
3LD4 ___ 1CC10-ORCO	1P 3W	280.-	380.-	445.-	530.-	535.-	665.-	975.-	1090.-	4660.-	1



\* Fill in the 5th, 6th & 7th of the type nos with the digits in ( ) to get complete MLFB e.g. for 10A 3 Pole Changeover with OFF (60°) the complete type no will be 3LD41023BB10-ORCO



# 3LD4 Control Switches

## Breaker Control Switch

**NEW**



Breaker Control Switch also referred to as **TNC or Trip-Neutral-Close Switch** is used in the control circuit of Low & Medium Voltage panels for switching circuit breakers. BCS switch has three positions – Trip, Neutral & Close used for switching the circuit breaker via auxiliary releases.

### Product Features

- Pistol grip handle for easy operation
- Spring return operation
- High electrical & mechanical life
- Available in 25A & 32A ratings
- Tested as per IEC 60947-5-1

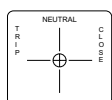

Description	Rating	Type#	Unit LP* ₹	Std. pkg. (nos.)
1 Trip + 1 Close	25A	3LD4205-2BB50-ORCO	1560.-	1
	32A	3LD4206-2BB50-ORCO	1845.-	
2 Trip + 2 Close	25A	3LD4205-4BB50-ORCO	1880.-	
	32A	3LD4206-4BB50-ORCO	2195.-	

## Multistep Switch



### Multistep 3 Way with OFF

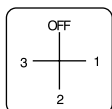

Type#	Description	Unit LP* ₹										Std. pkg. (nos.)
		6A (001)	10A (102)	16A (103)	20A (104)	25A (205)	32A (206)	40A (207)	63A (208)	100A (309)		
3LD4 ___1CC40-ORCO	1P 3W	280.-	475.-	550.-	565.-	595.-	670.-	950.-	1075.-	5815.-	1	
3LD4 ___2CC40-ORCO	2P 3W	385.-	555.-	670.-	800.-	915.-	980.-	1410.-	1585.-	8540.-		
3LD4 ___3CC40-ORCO	3P 3W	555.-	745.-	1135.-	1215.-	1350.-	1470.-	1875.-	2455.-	11165.-		
3LD4 ___4CC40-ORCO	4P 3W	715.-	955.-	1375.-	1505.-	1685.-	1855.-	2520.-	2935.-	14100.-		

### Multistep 4 Way with OFF

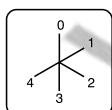

Type#	Description	Unit LP* ₹										Std. pkg. (nos.)
		6A (001)	10A (102)	16A (103)	20A (104)	25A (205)	32A (206)	40A (207)	63A (208)	100A (309)		
3LD4 ___1DD40-ORCO	1P 4W	320.-	425.-	800.-	865.-	955.-	1065.-	1210.-	1640.-	5145.-	1	
3LD4 ___2DD40-ORCO	2P 4W	555.-	805.-	945.-	970.-	1010.-	1170.-	1515.-	1915.-	7495.-		
3LD4 ___3DD40-ORCO	3P 4W	775.-	1080.-	1500.-	1570.-	1685.-	1935.-	2580.-	2935.-	20640.-		

### Multistep 5 Way with OFF

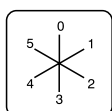

Type#	Description	Unit LP* ₹										Std. pkg. (nos.)
		6A (001)	10A (102)	16A (103)	20A (104)	25A (205)	32A (206)	40A (207)	63A (208)	100A (309)		
3LD4 ___1EE40-ORCO	1P 5W	360.-	675.-	920.-	1040.-	1200.-	1215.-	1500.-	1750.-	5160.-	1	
3LD4 ___2EE40-ORCO	2P 5W	655.-	1050.-	1220.-	1410.-	1635.-	1915.-	1970.-	2460.-	7490.-		

\* LP - List Price

# Multistep Switch

## Multistep 6 Way with OFF

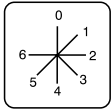

Type#	Description	Unit LP* ₹								Std. pkg. (nos.)
		6A (001)	10A (102)	16A (103)	20A (104)	25A (205)	32A (206)	40A (207)	63A (208)	
3LD4 ___ 1FF40-ORCO	1P 6W	470.-	760.-	885.-	975.-	1065.-	1245.-	1275.-	2065.-	1
3LD4 ___ 2FF40-ORCO	2P 6W	775.-	1145.-	1285.-	1450.-	1640.-	1985.-	2540.-	3315.-	

## Multistep 7 Way with OFF

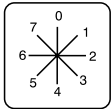

Type#	Description	Unit LP* ₹								Std. pkg. (nos.)
		6A (001)	10A (102)	16A (103)	20A (104)	25A (205)	32A (206)	40A (207)	63A (208)	
3LD4 ___ 1GG40-ORCO	1P 7W	475.-	785.-	970.-	1060.-	1215.-	1270.-	1320.-	2050.-	1

## Multistep 8 Way with OFF

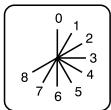

Type#	Description	Unit LP* ₹				Std. pkg. (nos.)
		6A (001)	10A (102)	16A (103)	20A (104)	
3LD4 ___ 1HH40-ORCO	1P 8W	540.-	665.-	950.-	1105.-	1

## Multistep 9 Way with OFF

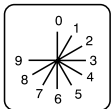

Type#	Description	Unit LP* ₹				Std. pkg. (nos.)
		6A (001)	10A (102)	16A (103)	20A (104)	
3LD4 ___ 1JJ40-ORCO	1P 9W	555.-	810.-	985.-	1170.-	1

## Multistep 10 Way with OFF

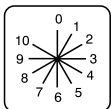

Type#	Description	Unit LP* ₹				Std. pkg. (nos.)
		6A (001)	10A (102)	16A (103)	20A (104)	
3LD4 ___ 1KK40-ORCO	1P 10W	655.-	855.-	1320.-	1775.-	1

## Multistep 11 Way with OFF

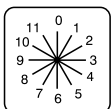

Type#	Description	Unit LP* ₹				Std. pkg. (nos.)
		6A (001)	10A (102)	16A (103)	20A (104)	
3LD4 ___ 1LL40-ORCO	1P 11W	775.-	930.-	1450.-	1915.-	1

\* Fill in the 5th, 6th & 7th of the type nos with the digits in () to get complete MLFB  
 e.g. for 6A 3 Pole Multistep 4 Way with OFF the complete type no will be 3LD40013DD40-ORCO

# Multistep Switch



## Multistep 3 Way without OFF

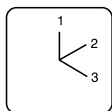

Type#	Description	Unit LP* ₹									Std. pkg. (nos.)
		6A (001)	10A (102)	16A (103)	20A (104)	25A (205)	32A (206)	40A (207)	63A (208)	100A (309)	
3LD4 ___ 1QB40-ORCO	1P 3W	265.-	455.-	555.-	565.-	705.-	730.-	1130.-	1270.-	4770.-	1
3LD4 ___ 2QB40-ORCO	2P 3W	385.-	690.-	785.-	860.-	925.-	950.-	1410.-	1665.-	8540.-	
3LD4 ___ 3QB40-ORCO	3P 3W	555.-	860.-	1170.-	1250.-	1350.-	1470.-	2065.-	2455.-	9170.-	
3LD4 ___ 4QB40-ORCO	4P 3W	715.-	955.-	1355.-	1545.-	1710.-	1820.-	4010.-	4430.-	9835.-	

## Multistep 4 Way without OFF

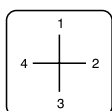

Type#	Description	Unit LP* ₹									Std. pkg. (nos.)
		6A (001)	10A (102)	16A (103)	20A (104)	25A (205)	32A (206)	40A (207)	63A (208)	100A (309)	
3LD4 ___ 1RC40-ORCO	1P 4W	305.-	500.-	675.-	735.-	845.-	885.-	1220.-	1705.-	5815.-	1
3LD4 ___ 2RC40-ORCO	2P 4W	435.-	720.-	800.-	920.-	1000.-	1090.-	1470.-	1915.-	8975.-	
3LD4 ___ 3RC40-ORCO	3P 4W	590.-	705.-	1270.-	1405.-	1590.-	1765.-	1925.-	2565.-	11835.-	

## Multistep 5 Way without OFF

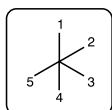

Type#	Description	Unit LP* ₹									Std. pkg. (nos.)
		6A (001)	10A (102)	16A (103)	20A (104)	25A (205)	32A (206)	40A (207)	63A (208)	100A (309)	
3LD4 ___ 1SD40-ORCO	1P 5W	360.-	525.-	730.-	835.-	950.-	1170.-	1500.-	1920.-	5135.-	1
3LD4 ___ 2SD40-ORCO	2P 5W	655.-	885.-	1000.-	1285.-	1505.-	1625.-	2080.-	2640.-	7380.-	

## Multistep 6 Way without OFF

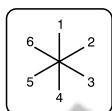

Type#	Description	Unit LP* ₹									Std. pkg. (nos.)
		6A (001)	10A (102)	16A (103)	20A (104)	25A (205)	32A (206)	40A (207)	63A (208)	100A (309)	
3LD4 ___ 1TE40-ORCO	1P 6W	380.-	470.-	915.-	975.-	1065.-	1215.-	1415.-	1795.-	8540.-	1
3LD4 ___ 2TE40-ORCO	2P 6W	745.-	900.-	1230.-	1545.-	1885.-	1940.-	1970.-	2515.-	17040.-	

## Multistep 7 Way without OFF

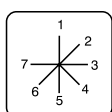

Type#	Description	Unit LP* ₹									Std. pkg. (nos.)
		6A (001)	10A (102)	16A (103)	20A (104)	25A (205)	32A (206)	40A (207)	63A (208)	100A (309)	
3LD4 ___ 1UF40-ORCO	1P 7W	470.-	595.-	690.-	955.-	1260.-	1265.-	1515.-	2250.-	1	

\* LP - List Price

# Multistep Switch

## Multistep 8 Way without OFF

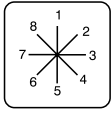

Type#	Description	Unit LP* ₹				Std. pkg. (nos.)
		6A (001)	10A (102)	16A (103)	20A (104)	
3LD4 ___ 1VG40-ORCO	1P 8W	475.-	940.-	1035.-	1105.-	1

## Multistep 9 Way without OFF

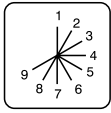

Type#	Description	Unit LP* ₹				Std. pkg. (nos.)
		6A (001)	10A (102)	16A (103)	20A (104)	
3LD4 ___ 1WH40-ORCO	1P 9W	555.-	970.-	1645.-	2040.-	1

## Multistep 10 Way without OFF

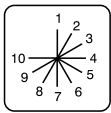

Type#	Description	Unit LP* ₹				Std. pkg. (nos.)
		6A (001)	10A (102)	16A (103)	20A (104)	
3LD4 ___ 1XJ40-ORCO	1P 10W	595.-	990.-	1820.-	2455.-	1

## Multistep 11 Way without OFF

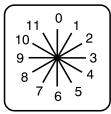

Type#	Description	Unit LP* ₹				Std. pkg. (nos.)
		6A (001)	10A (102)	16A (103)	20A (104)	
3LD4 ___ 1YK40-ORCO	1P 11W	620.-	1010.-	1955.-	2585.-	1

## Multistep 12 Way without OFF

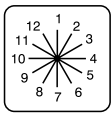

Type#	Description	Unit LP* ₹				Std. pkg. (nos.)
		6A (001)	10A (102)	16A (103)	20A (104)	
3LD4 ___ 1ZL40-ORCO	1P 12W	675.-	1035.-	2040.-	2620.-	1

\* Fill in the 5th, 6th & 7th of the type nos with the digits in ( ) to get complete MLFB  
e.g. for 6A 1 Pole Multistep 4 Way with OFF the complete type no will be 3LD40013DD40-ORCO

\* LP - List Price





# Power monitoring made simple

Power monitoring devices and software from the  
SENTRON portfolio

- Ease of operation and visualization
- Scalability
- Cyber Security
- Various communication protocols

[www.siemens.com/powermonitoring](http://www.siemens.com/powermonitoring)

**SIEMENS**

# Energy Management System

## (A) Hardware Solutions

### Complete Range of Power Monitoring Devices for LV and HV Networks



#### PAC 3120: Cost Effective Solution for digital measurement

- Display of instantaneous, maximum and minimum values
- Measurement of Active & Reactive Power (Import / Export / Net)
- CT polarity reversal correction from the device

#### PAC 3220: Specialist solution for precise energy data capture

- Dual Metering function
- Dual ethernet interface for MODBUS TCP communication
- Optional communication over PROFIBUS DP and PROFINET

#### PAC 4200: Professional solution for communication and monitoring

- Integrated gateway functionality for MODBUS RTU devices
- Reliable event recording with battery backup
- Sliding window for maximum demand

Description	Type	Unit LP* ₹
<b>PAC 3120</b> with integrated RS 485 port for MODBUS RTU Class 0.5 accuracy, screw terminals AC/DC wide voltage power supply 100 ... 250 V ±10% 50/60Hz	7KM3120-0BA01-1DA0#	53240.-
<b>PAC 3220</b> with integrated dual ethernet port for MODBUS TCP Class 0.5 accuracy, screw terminals With AC/DC wide voltage power supply 100 ... 250 V ±10% 50/60Hz	7KM3220-0BA01-1DA0#	72730.-
<b>PAC 4200</b> with integrated ethernet port for MODBUS TCP Class 0.2s accuracy, screw terminals With AC/DC wide voltage power supply 95...240V AC ±10%, 50/60Hz, 110...340V DC ±10%	7KM4212-0BA00-3AA0#	POR

#### Expansion Modules (for PAC3220 and PAC4200)

Description	Type	Unit LP * ₹
PROFIBUS DP expansion module	7KM9300-0AB01-0AA0	25965.-
RS485 expansion module for MODBUS RTU	7KM9300-0AM00-0AA0	20050.-
Switched Ethernet PROFINET V3 expansion module	7KM9300-0AE02-0AA0	POR
Digital Expansion Module 4DI/2DO <sup>5</sup>	7KM9200-0AB00-0AA0	POR
Analog Expansion Module	7KM9200-0AD00-0AA0	POR

# For extra low DC voltage (22 ... 65 V DC ± 10 %) option, please contact your nearest Siemens partner.  
<sup>5</sup> Maximum 2 nos.can be connected if communication expansion module is not connected.  
 For exact configuration, contact your nearest Siemens Sales Office.

## (B) Software Solution

Description	Unit LP* ₹
SETRON powermanager: Complete Energy Management Software	POR

POR: Price On Request  
 Std. Pkg. = 1 unit  
 \* LP - List Price

**PAC EXPANSION Modules**



7KM PAC 3220



7KM PAC 4200

---



MODBUS RTU



PROFINET



PROFIBUS DP



I(N), I(Diff), Analog



PAC 4DI/2DO





## Energy management

Detection, transparency and control of energy flows

101 0  
1 11101  
0011011  
10101  
00101

## Adaptability to Industry 4.0

Easy digitalization of "brownfield" projects

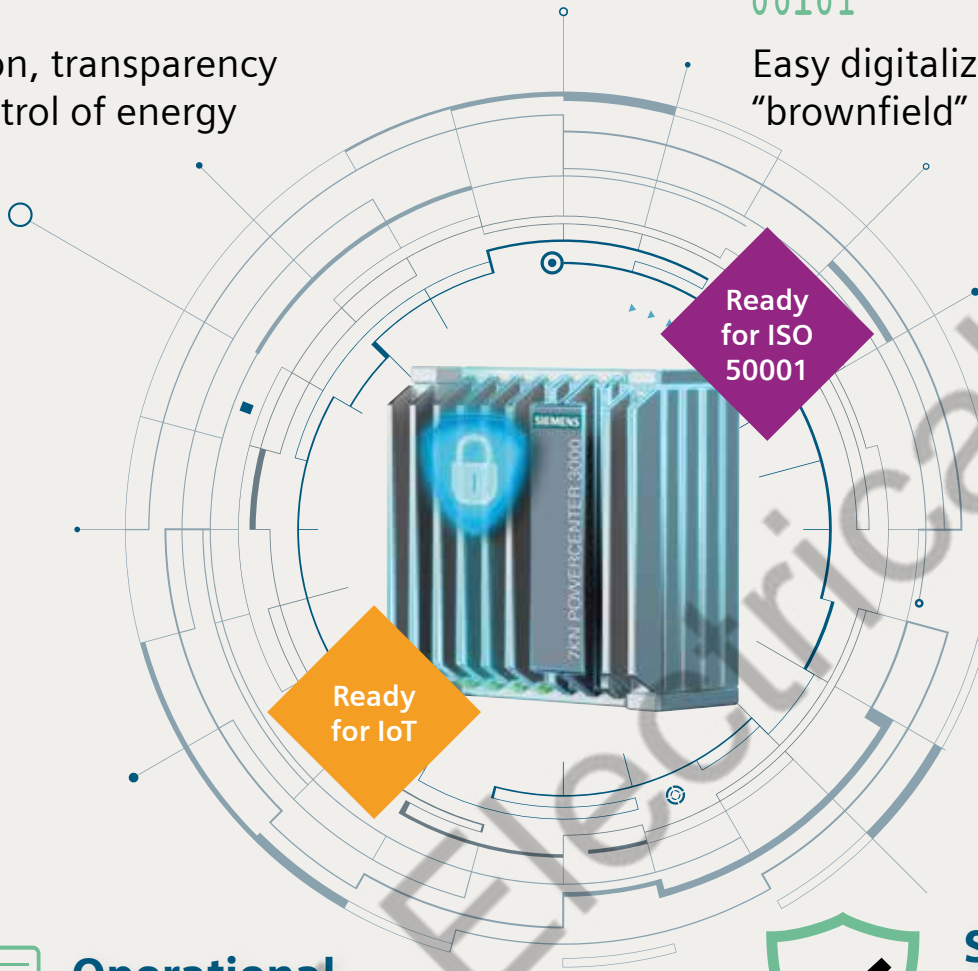

## Operational flexibility

Choice of visualization via Web Interface, on premise or connect to Cloud



## Safety through reliability

Identifying potential outages at an early stage enable preventing them

# SENTRON Powercenter 3000

Gateway to the digitalization of low-voltage power distribution

Siemens/SENTRON-Digitalization

# SIEMENS

# Single Platform For Intelligent Power Distribution Management

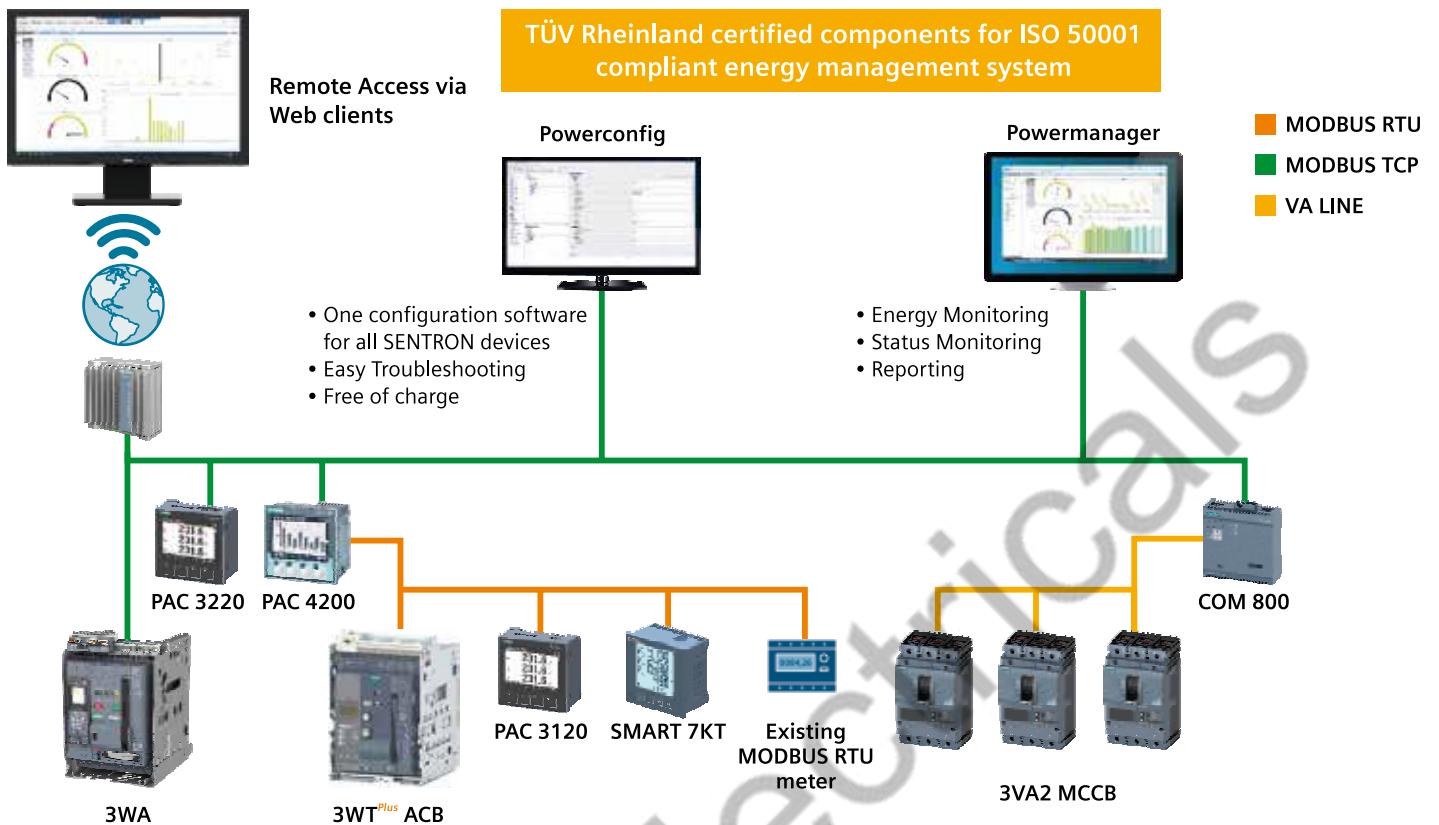

Energy Management System

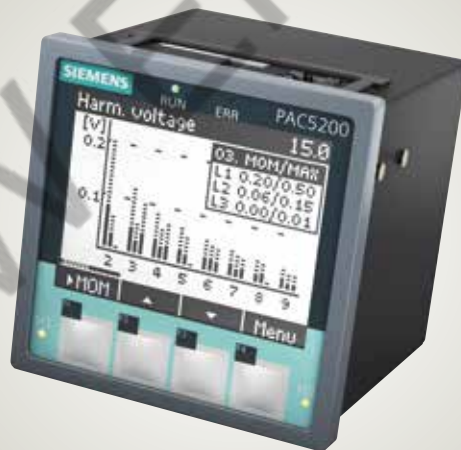

## Power Quality Measurement

### SENTRON 7KM PAC 5200

- Measured value capture in accordance with power quality standard IEC 61000-4-30
- Recording of power quality anomalies like sag, swell and interruption
- Integrated web server to set parameters and display measured values on HTML pages

For more details, contact your nearest Siemens partner.

[www.siemens.com/powermonitoring](http://www.siemens.com/powermonitoring)



## DIN Rail Mounted Meters for energy monitoring in Infra and Building Applications

Description	Type	Unit LP* ₹
PAC 2200 DIN rail meter with integrated RS 485 port for MODBUS RTU 65A direct connection Class 1 accuracy	7KM2200-2EA40-1DA1	35530.-
PAC 2200 DIN rail meter with integrated ethernet port for MODBUS TCP 65A direct connection Class 1 accuracy	7KM2200-2EA40-1EA1	POR
PAC3200T DIN rail meter with integrated ethernet port for MODBUS TCP High accuracy of class 0.5 Without display	7KM3200-0CA01-1AA0	POR

POR: Price On Request

Std. Pkg. = 1 unit

\* LP - List Price

### PAC 2200 and PAC 3200T:

Reliable and Easy energy monitoring for DIN rail Applications

- Compact design on standard mounting rail
- Integrated digital input (DI) and Digital output (DO)
- Integrated web server
- Neutral conductor current display
- THD Measurement



## SENTRON 7KT PAC 1600 DIN Rail mounted compact Energy Meters

- PAC 1600 range of single phase and three phase meters
- Space saving mounting by very slim construction
- Energy counters for active, reactive and apparent energy
- THD: Up to 15<sup>th</sup> harmonics

[www.siemens.com/powermonitoring](http://www.siemens.com/powermonitoring)



# 7KT PAC1200

Multichannel current measuring system for flexible multichannel monitoring in final distribution

#### Current Sensors

- Versions: 40 A, 63 A

#### Sensor Bar

- Versions available for 3, 6, 9, 12

#### Data Manager

- Connection of up to 96 sensors (40A/63A)
- DIN rail installation (4MW)

#### Communication/ Software:

- Modbus TCP/ IP
- Simple system onfiguration via web server
- Easy access to energy data with mobile app (iOS/Android)

\*For more details, please contact your nearest Siemens Sales Office

[www.siemens.com/powermonitoring](http://www.siemens.com/powermonitoring)

**SIEMENS**

- Modbus TCP/IP communication
- Simple configuration of system via powerconfig and web server
- Visualization of consumption via Webserver and Mobile App (Android /iOS)

- Flexible sensor bars and current sensors to record up to 96 circuits in one system
- Current sensors simply plug onto the sensor bars, eliminating extensive wiring

**fast**

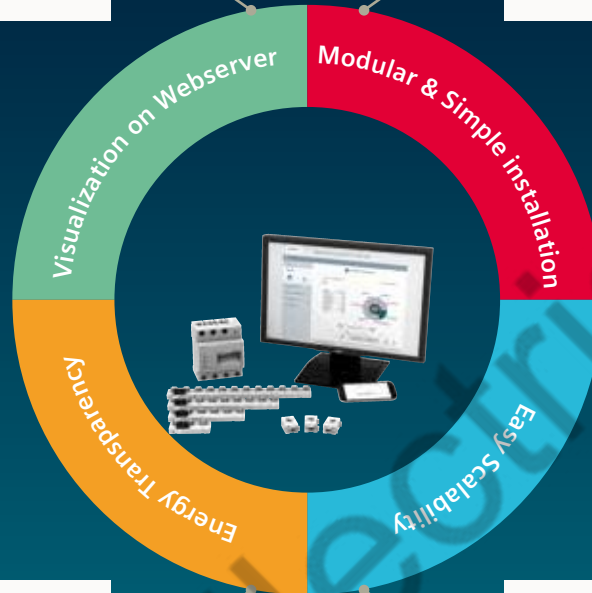

plug  
and  
play

- Targeted detection of power guzzlers
- Simultaneous display of power consumption and costs
- Ensures optimal power monitoring

- Easy to Upgrade
- Scale up the system without any interruption or cumbersome wiring



Easy



Transparent



Cost-efficient

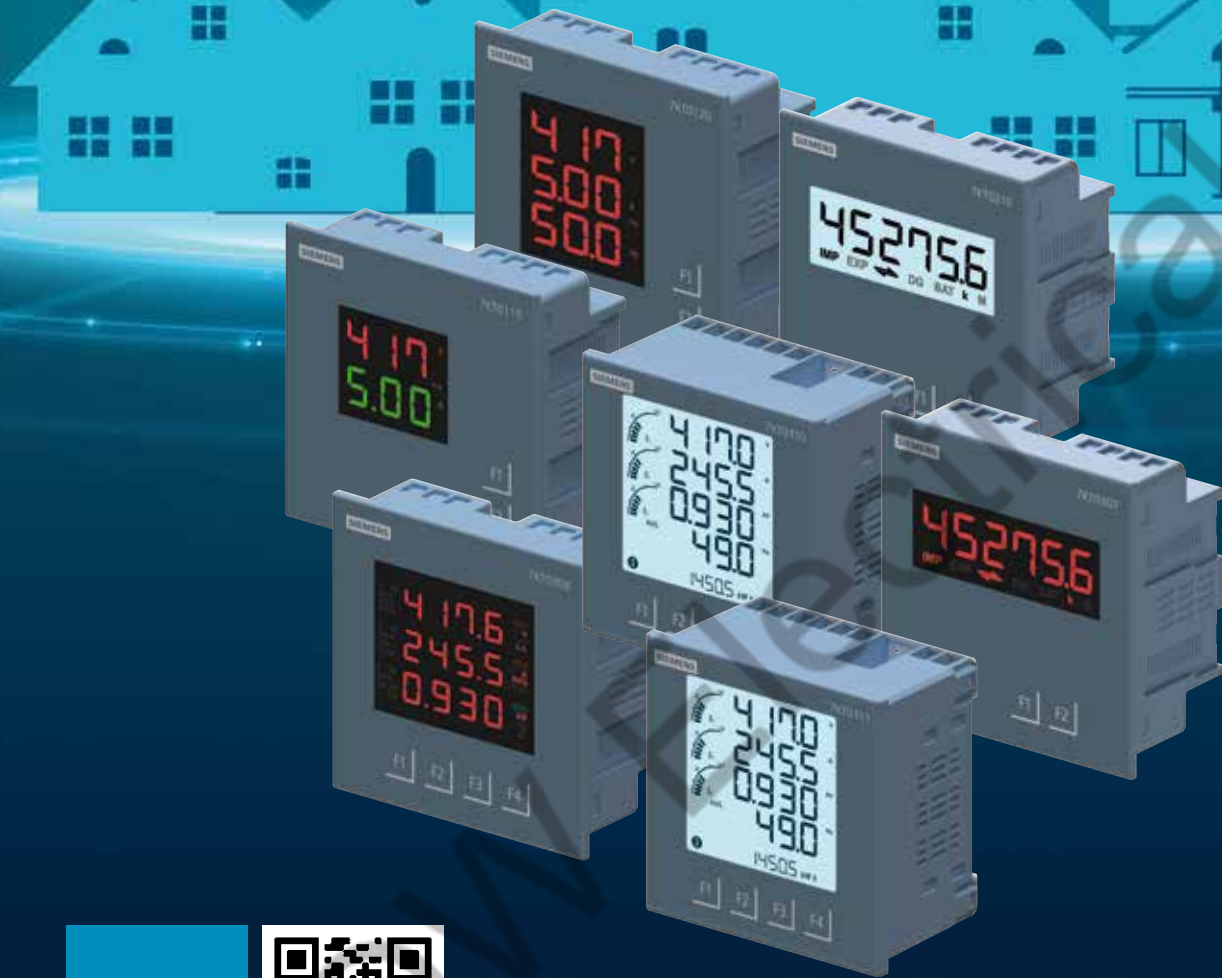

for more  
info scan  
QR code



# SMART 7KT

## Power Monitoring Devices

Expanding the reach of technology

**SIEMENS**

SMART 7KT

NEW

# Power Monitoring Devices

## SMART 7KT Discrete Panel Meter

Accurate and easy visualization for all the basic measurements

- Tested accuracy as per IEC 61557-12 and IEC 62053
- RoHS compliant
- Modern aesthetics with soft touch keys
- Large LED (multicolored) display for easy visualization

Description	Type	Unit LP ₹
VAF meter <b>NEW</b>	7KT0120	3840.-
VA meter <b>NEW</b>	7KT0110	3520.-
3 phase energy meter *	7KT0210	POR

\*Please contact your nearest Siemens Sales office for more details.



## SMART 7KT Multi Function Meter

Broad range of uses in industry and infrastructure

- Tested accuracy as per IEC 61557-12 and IEC 62053
- RoHS compliant
- Graphical representation of current loading in the LCD display meters
- Modern aesthetics with soft touch keys
- Integrated Modbus RTU communication over RS 485
- Measurement of 30+ electrical parameters

Description	Type	Unit LP ₹
LCD Class 0.5s <b>NEW</b>	7KT0311	19290.-
LCD Class 1	7KT0310	16120.-
Multi-line LED Class 1 <b>NEW</b>	7KT0308	12000.-
Single-line LED Class 1 <b>NEW</b>	7KT0307	8000.-

POR: Price On Request

Std. Pkg. = 1 unit

\* LP - List Price



Power Monitoring Devices



for more info scan QR code

3TS Capacitor  
Duty Contactor



4RB LV  
Capacitors



7UG0 APFC  
controller



4KA Detuned  
Reactors



# Power Quality Solutions

[www.siemens.co.in](http://www.siemens.co.in)

**SIEMENS**

# SIECAP™ LV Power Capacitors

## ND+ (Normal Duty) - Al Can, MPP resin filled

- High pulse current withstand capability (upto 200.I<sub>N</sub>)
- Long life expectancy upto 100000 hrs
- Self healing type
- Inbuilt over pressure disconnecter
- Shock hazard protected SIGUT terminals



Rated voltage V	kvar @ 50 Hz	Type	Unit LP* ₹	Std. pkg. (nos.)
440	5	4RB2050-3EE52-8K	2675.-	1
	6	4RB2060-3EE52-8K	2510.-	1
	7	4RB2070-3EE52-8K	2930.-	1
	7.5	4RB2075-3EE52-8K	3145.-	1
	8.3	4RB2083-3EE52-8K	3480.-	1
	9	4RB2090-3EE52-8K	3770.-	1
	10	4RB2100-3EE52-8K	4195.-	1
	12.5	4RB2125-3EE52-8K	4525.-	1
	15	4RB2150-3EE52-8K	5425.-	1
	16.7	4RB2167-3EE52-8K	6030.-	1
	20	4RB2200-3EE52-8K	7220.-	1
	20.8	4RB2208-3EE52-8K	7520.-	1
	25	4RB2250-3EE52-8K	9040.-	1
	28	4RB2280-3EE52-8K	10120.-	1
30	4RB2300-3EE52-8K	10850.-	1	

Rated voltage V	kvar @ 50 Hz	Type	Unit LP* ₹	Std. pkg. (nos.)
480	5	4RB2050-3EJ52-8K	2465.-	1
	5.5	4RB2055-3EJ52-8K	2725.-	1
	8.3	4RB2083-3EJ52-8K	3635.-	1
	10.4	4RB2104-3EJ52-8K	4555.-	1
	11.1	4RB2111-3EJ52-8K	4645.-	1
	12.5	4RB2125-3EJ52-8K	4765.-	1
	13.8	4RB2138-3EJ52-8K	5255.-	1
	15	4RB2150-3EJ52-8K	5710.-	1
	16.7	4RB2167-3EJ52-8K	6350.-	1
	20.8	4RB2208-3EJ52-8K	7920.-	1
	25	4RB2250-3EJ52-8K	9510.-	1
	27.7	4RB2277-3EJ52-8K	10540.-	1
	30	4RB2300-3EJ52-8K	11420.-	1

# Purchase MOQ for our dealers is in multiples of standard packing, please contact your nearest Siemens Sales Office for further details.

For information on less than 5 kvar and other kvar ratings at different voltages and frequency and use with detuned reactors, please contact your nearest Siemens Sales Office.



Std. Pkg. = 1 unit

\* LP - List Price

# SIECAP™ LV Power Capacitors

## HD (Heavy Duty) - Al Can, MPP resin filled

- High pulse current withstand capability (up to  $250.I_N$ )
- Long life expectancy up to 130000 hrs
- Self healing type
- Inbuilt over pressure disconnecter
- Shock hazard protected SIGUT terminals



Rated voltage V	kvar @ 50 Hz	Type	Unit LP* ₹	Std. pkg. (nos.)
415	5	4RB2050-3EB53-8K	3280.-	1
	7.5	4RB2075-3EB53-8K	4360.-	1
	10.4	4RB2104-3EB53-8K	6050.-	1
	12.5	4RB2125-3EB53-8K	6565.-	1
	15	4RB2150-3EB53-8K	7880.-	1
	20	4RB2200-3EB53-8K	10505.-	1
	25	4RB2250-3EB53-8K	13130.-	1
440	5	4RB2050-3EE53-8K	3380.-	1
	7.5	4RB2075-3EE53-8K	4360.-	1
	10	4RB2100-3EE53-8K	5815.-	1
	12.5	4RB2125-3EE53-8K	6565.-	1
	15	4RB2150-3EE53-8K	7880.-	1
	20	4RB2200-3EE53-8K	10505.-	1
	25	4RB2250-3EE53-8K	13130.-	1
	28.1	4RB2281-3EE53-8K	14750.-	1
	30	4RB2300-3EE53-8K	15750.-	1

Rated voltage V	kvar @ 50 Hz	Type	Unit LP* ₹	Std. pkg. (nos.)
480	5	4RB2050-3EJ53-8K	3380.-	1
	6.3	4RB2063-3EJ53-8K	3780.-	1
	8.3	4RB2083-3EJ53-8K	4980.-	1
	10.4	4RB2104-3EJ53-8K	5665.-	1
	11	4RB2110-3EJ53-8K	5990.-	1
	12.5	4RB2125-3EJ53-8K	6800.-	1
	13.8	4RB2138-3EJ53-8K	7510.-	1
	15	4RB2150-3EJ53-8K	8160.-	1
	16.7	4RB2167-3EJ53-8K	9080.-	1
	18.7	4RB2187-3EJ53-8K	10170.-	1
	20	4RB2200-3EJ53-8K	10885.-	1
	22	4RB2220-3EJ53-8K	11960.-	1
	25	4RB2250-3EJ53-8K	13590.-	1
	28.1	4RB2281-3EJ53-8K	15280.-	1
	30	4RB2300-3EJ53-8K	16310.-	1
525	5	4RB2050-3FC53-8K	3485.-	1
	6.3	4RB2063-3FC53-8K	3910.-	1
	8.3	4RB2083-3FC53-8K	5140.-	1
	10.4	4RB2104-3FC53-8K	5850.-	1
	12.5	4RB2125-3FC53-8K	7040.-	1
	13.2	4RB2132-3FC53-8K	7430.-	1
	15	4RB2150-3FC53-8K	8435.-	1
	16.7	4RB2167-3FC53-8K	9410.-	1
	20	4RB2200-3FC53-8K	11250.-	1
	25	4RB2250-3FC53-8K	14065.-	1
	26.5	4RB2265-3FC53-8K	14910.-	1
	30	4RB2300-3FC53-8K	16880.-	1
	33.1	4RB2331-3FC53-8K	18620.-	1

# Purchase MOQ for our dealers is in multiples of standard packing, please contact your nearest Siemens Sales Office for further details.

For information on less than 5 kvar and other kvar ratings at different voltages and frequency and use with detuned reactors, please contact your nearest Siemens Sales Office.



Std. Pkg. = 1 unit

\* LP - List Price



# SIECAP™ LV Power Capacitors



## SHD (Super Heavy Duty) - Al Can, MPP resin filled

- High pulse current withstand capability (upto 500.I<sub>N</sub>)
- Long life expectancy upto 200000 hrs
- Self healing type
- Inbuilt over pressure disconnecter
- Shock hazard protected SIGUT terminals

Rated voltage V	kvar @ 50 Hz	Type	Unit LP* ₹	Std. pkg. (nos.)
415	5	4RB1050-3EB50-8K	3740.-	1
	6.3	4RB1063-3EB50-8K	4180.-	1
	7.5	4RB1075-3EB50-8K	4975.-	1
	10.4	4RB1104-3EB50-8K	6905.-	1
	12.5	4RB1125-3EB50-8K	7495.-	1
	15	4RB1150-3EB50-8K	8995.-	1
	20	4RB1200-3EB50-8K	11995.-	1
	25	4RB1250-3EB50-8K	14995.-	1
	28.1	4RB1281-3EB50-8K	16840.-	1
	30	4RB1300-3EB50-8K	17990.-	1
	33	4RB1330-3EB50-8K	19790.-	1
440	5	4RB1050-3EE50-8K	3860.-	1
	7.5	4RB1075-3EE50-8K	4975.-	1
	10	4RB1100-3EE50-8K	6640.-	1
	10.4	4RB1104-3EE50-8K	6905.-	1
	12.5	4RB1125-3EE50-8K	7495.-	1
	15	4RB1150-3EE50-8K	8995.-	1
	16.7	4RB1167-3EE50-8K	10015.-	1
	20	4RB1200-3EE50-8K	11995.-	1
	25	4RB1250-3EE50-8K	14995.-	1
	28.1	4RB1281-3EE50-8K	16840.-	1
	30	4RB1300-3EE50-8K	17990.-	1
33.1	4RB1331-3EE50-8K	19850.-	1	
480	5	4RB1050-3EJ50-8K	3860.-	1
	6.3	4RB1063-3EJ50-8K	4315.-	1
	8.3	4RB1083-3EJ50-8K	5690.-	1
	10.4	4RB1104-3EJ50-8K	6460.-	1
	11	4RB1111-3EJ50-8K	6840.-	1
	12.5	4RB1125-3EJ50-8K	7765.-	1
	13.8	4RB1138-3EJ50-8K	8580.-	1
	15	4RB1150-3EJ50-8K	9320.-	1
	16.7	4RB1167-3EJ50-8K	10370.-	1
	18.7	4RB1187-3EJ50-8K	11615.-	1
	20	4RB1200-3EJ50-8K	12425.-	1
	22	4RB1220-3EJ50-8K	13660.-	1
	25	4RB1250-3EJ50-8K	15520.-	1
	28.1	4RB1281-3EJ50-8K	17450.-	1
	30	4RB1300-3EJ50-8K	18625.-	1
31	4RB1310-3EJ50-8K	19255.-	1	
33	4RB1330-3EJ50-8K	20500.-	1	

Rated voltage V	kvar @ 50 Hz	Type	Unit LP* ₹	Std. pkg. (nos.)
525	5	4RB1050-3FC50-8K	3975.-	1
	6.3	4RB1063-3FC50-8K	4465.-	1
	8.3	4RB1083-3FC50-8K	5870.-	1
	10.4	4RB1104-3FC50-8K	6680.-	1
	12.5	4RB1125-3FC50-8K	8035.-	1
	13.2	4RB1132-3FC50-8K	8485.-	1
	15	4RB1150-3FC50-8K	9635.-	1
	16.7	4RB1167-3FC50-8K	10740.-	1
	20	4RB1200-3FC50-8K	12845.-	1
	25	4RB1250-3FC50-8K	16060.-	1
	26.5	4RB1265-3FC50-8K	17030.-	1
690	30	4RB1300-3FC50-8K	19280.-	1
	33.1	4RB1331-3FC50-8K	21265.-	1
	5.3	4RB1053-3GK50-8K	3515.-	1
	6.9	4RB1068-3GK50-8K	4590.-	1
	10.4	4RB1104-3GK50-8K	6905.-	1
	12.5	4RB1125-3GK50-8K	8305.-	1
	14.6	4RB1146-3GK50-8K	9695.-	1
	20	4RB1200-3GK50-8K	13280.-	1
	25	4RB1250-3GK50-8K	16600.-	1

# Purchase MOQ for our dealers is in multiples of standard packing, please contact your nearest Siemens Sales Office for further details

For information on less than 5 kvar and other kvar ratings at different voltages and frequency and use with detuned reactors, please contact your nearest Siemens Sales Office.

Std. Pkg. = 1 unit

\* LP - List Price

# Harmonics filter

## Detuned reactor

### Features

- Insulation class H
- High linearity
- Temperature control via micro switch
- Low losses and low noise



### Copper Detuned Reactors

Bank size	Detuning factor	Type	Unit LP* ₹
5kvar	5.67%	4KA1220-1AC01-0AA0	18150.-
10kvar	5.67%	4KA1220-3AC01-0AA0	21540.-
12.5kvar	5.67%	4KA1220-4AC01-0AA0	25210.-
15kvar	5.67%	4KA1220-5AC01-0AA0	27235.-
20kvar	5.67%	4KA1220-6AC01-0AA0	29130.-
25kvar	5.67%	4KA1220-7AC01-0AA0	31165.-
5kvar	7%	4KA1220-1AA01-0AA0	18140.-
10kvar	7%	4KA1220-3AA01-0AA0	24880.-
12.5kvar	7%	4KA1220-4AA01-0AA0	26860.-
15kvar	7%	4KA1220-5AA01-0AA0	31020.-
20kvar	7%	4KA1220-6AA01-0AA0	33045.-
25kvar	7%	4KA1220-7AA01-0AA0	34770.-
50kvar	7%	4KA1220-2BA01-0AA0	61950.-
75kvar	7%	4KA1220-3BA03-0AA0	86880.-
100kvar	7%	4KA1220-4BA03-0AA0	109350.-
5kvar	14%	4KA1220-1AB01-0AA0	23880.-
12.5kvar	14%	4KA1220-4AB01-0AA0	40075.-
15kvar	14%	4KA1220-5AB01-0AA0	46925.-
20kvar	14%	4KA1220-6AB01-0AA0	57100.-
25kvar	14%	4KA1220-7AB01-0AA0	64205.-
50kvar	14%	4KA1220-2BB01-0AA0	104260.-
75kvar	14%	4KA1220-3BB03-0AA0	133385.-
100kvar	14%	4KA1220-4BB03-0AA0	193935.-

### Aluminium Detuned Reactors

Bank size	Detuning factor	Type	Unit LP* ₹
5kvar	5.67%	4KA1420-1AC01-0AA0	13485.-
10kvar	5.67%	4KA1420-3AC01-0AA0	17195.-
12.5kvar	5.67%	4KA1420-4AC01-0AA0	18845.-
15kvar	5.67%	4KA1420-5AC01-0AA0	22285.-
20kvar	5.67%	4KA1420-6AC01-0AA0	25410.-
25kvar	5.67%	4KA1420-7AC01-0AA0	25730.-
50kvar	5.67%	4KA1420-2BC01-0AA0	46815.-
5kvar	7%	4KA1420-1AA01-0AA0	14355.-
10kvar	7%	4KA1420-3AA01-0AA0	18470.-
12.5kvar	7%	4KA1420-4AA01-0AA0	20425.-
15kvar	7%	4KA1420-5AA01-0AA0	23025.-
20kvar	7%	4KA1420-6AA01-0AA0	24520.-
25kvar	7%	4KA1420-7AA01-0AA0	26225.-
50kvar	7%	4KA1420-2BA01-0AA0	45090.-
75kvar	7%	4KA1420-3BA03-0AA0	61260.-
100kvar	7%	4KA1420-4BA03-0AA0	80115.-
5kvar	14%	4KA1420-1AB01-0AA0	19545.-
10kvar	14%	4KA1420-3AB01-0AA0	29315.-
12.5kvar	14%	4KA1420-4AB01-0AA0	31900.-
15kvar	14%	4KA1420-5AB01-0AA0	37765.-
20kvar	14%	4KA1420-6AB01-0AA0	41930.-
25kvar	14%	4KA1420-7AB01-0AA0	51160.-
50kvar	14%	4KA1420-2BB01-0AA0	90510.-



## 3TS Capacitor duty Contactors

Now in  
TI - GREY **NEW**

The 3TS capacitor duty contactor (with **patented** de-latching technology) provides a reliable and economical solution for capacitor switching applications.

### Features and Benefits

- De-latching operating principle
- SIGUT Termination technique
- Finger touch proof terminals
- Compact Dimensions
- DIN / Screw mounting
- Reliable switching of capacitor banks
- Ease of wiring (can obviate use of lugs)
- Operator Safety
- Space saving
- Flexible mounting



Capacitor kVAr 415V, 3ph, 50Hz	Built-in aux. contacts	Type <sup>®</sup>	Unit LP ₹	Built-in aux. contacts	Type <sup>®</sup>	Unit LP ₹	Std. pkg. (nos.)
5 kvar <b>NEW</b>	1 NO	3TS2110-0A..5-8K <sup>†</sup>	2420.-				
7 kvar	1 NO	3TS1110-0A..5-8K <sup>†</sup>	2660.-				
10 kvar <b>NEW</b>	–	3TS2200-0A..5-8K <sup>†</sup>	2890.-	1NO+1NC	3TS2211-0A..5-8K	3315.-	
12.5 kvar	–	3TS1200-0A..5-8K <sup>†</sup>	2960.-	1NO+1NC	3TS1211-0A..5-8K	3385.-	1
16 kvar	–	3TS1300-0A..5-8K <sup>†</sup>	4070.-	1NO+1NC	3TS1311-0A..5-8K	4490.-	1
20 kvar	–	3TS1400-0A..5-8K <sup>†</sup>	4585.-	1NO+1NC	3TS1411-0A..5-8K	4995.-	1
25 kvar	–	3TS1500-0A..5-8K <sup>†</sup>	5295.-	1NO+1NC	3TS1511-0A..5-8K	5725.-	1
30 kvar <b>NEW</b>	–	3TS2500-0A..5-8K <sup>†</sup>	8250.-	1NO+1NC	3TS2511-0A..5-8K	8675.-	1
40 kvar <b>NEW</b>	2 NO + 2 NC	3TS2722-0A..5-8K	14000.-				
50 kvar	2 NO + 2 NC	3TS1722-0A..5-8K	16390.-				

<sup>†</sup> Facility to add one contact block of 1NO / 1NC

@ AC 50Hz coil code - Please enter coil codes from table below

Code	For 3TS contactors		
	F0	P0	R0
Coil voltage (V)	110	230	415

Auxiliary contact blocks

For contactor	Description	Type	Unit LP ₹	Std. pkg. (nos.)
3TS1110-3TS1500	1NO	■ 3TX4010-2A	230.-	10
	1NC	■ 3TX4001-2A	230.-	10

## 3MT7 Capacitor Duty Contactors **NEW**

Capacitor kVar 440V AC, 3Ph, 50Hz	Built-in aux. contacts	Type	Unit LP ₹	Std. pkg. (nos.)
60kVar	1NO+2NC	3MT70060JA126A..	17420.-	1
80kVar	1NO+2NC	3MT70080JA126A..	21385.-	1
100kVar	1NO+2NC	3MT70100JA126A..	22225.-	1

Please add coil code from adjacent table

Note: For SIRIUS 3RT26 Capacitor Duty Contactors - Please contact Siemens

Refer Page No 41 for Capacitor Duty Contactor Spares

Coil 50/60Hz for 60 kvar contactor					
Coil Code	C2	G2	N2	P2	R2
Voltage	24V AC	110V AC	■ 220V AC	■ 240V AC	415V AC

Coil 50Hz for 80 & 100 kvar contactors				
Coil Code	F0	M0	U0	V0
Voltage	110V AC	■ 220V AC	■ 240V AC	415V AC



## Automatic Power Factor Correction Relay (APFC relay)

### Features

- Easy accessibility of parameters
- Universal control supply—optimizing the no of variants
- Automatic/ Linear/ rotational switching modes of banks
- Selectable 1A/ 5A current input
- LCD version with RS485 Communication MODBUS RTU Protocol
- Confirms to IEC60947-5-1, carry CE and RoHS Compliant



for more info scan QR code



7UG0572-1GT20

Description	Type	Unit LP ₹	Std. pkg. (nos.)
Automatic Power factor correction relay (APFC relay)	8 Stage with LCD display	7UG0571-1FT20	22235.-
	12 Stage with LCD display	7UG0572-1GT20	23815.-
	12 stage with LED display	7UG0572-1GT21	13620.-



# Siemens Reyrolle Protection Relays

Relays for every application

## Applications

- Feeder Protection
- Motor Protection
- Transformer Protection

## Features

- Non Drawout / Drawout variants
- Programmable Tri-color LED's
- Communication: MODBUS RTU / IEC 103 and optional IEC 61850
- 1000 events / 10 disturbance records
- Programmable logic editor
- Easy Parameterization & Monitoring with ReyDisp Software

[www.siemens.com/Reyrolle](http://www.siemens.com/Reyrolle)

**SIEMENS**

# Portfolio Overview

Feeder Protection

Non-Directional  
Fixed



7SR1002 / 3

Directional  
Fixed



7SR1004

Non-Directional  
Drawout



7SR11

Directional  
Drawout



7SR12

Motor Protection

Non-Directional | Fixed



7SR105

Directional | Drawout



7SR17

Transformer Protection

Directional | Drawout



7SR242

Check synchronizing



7SR157

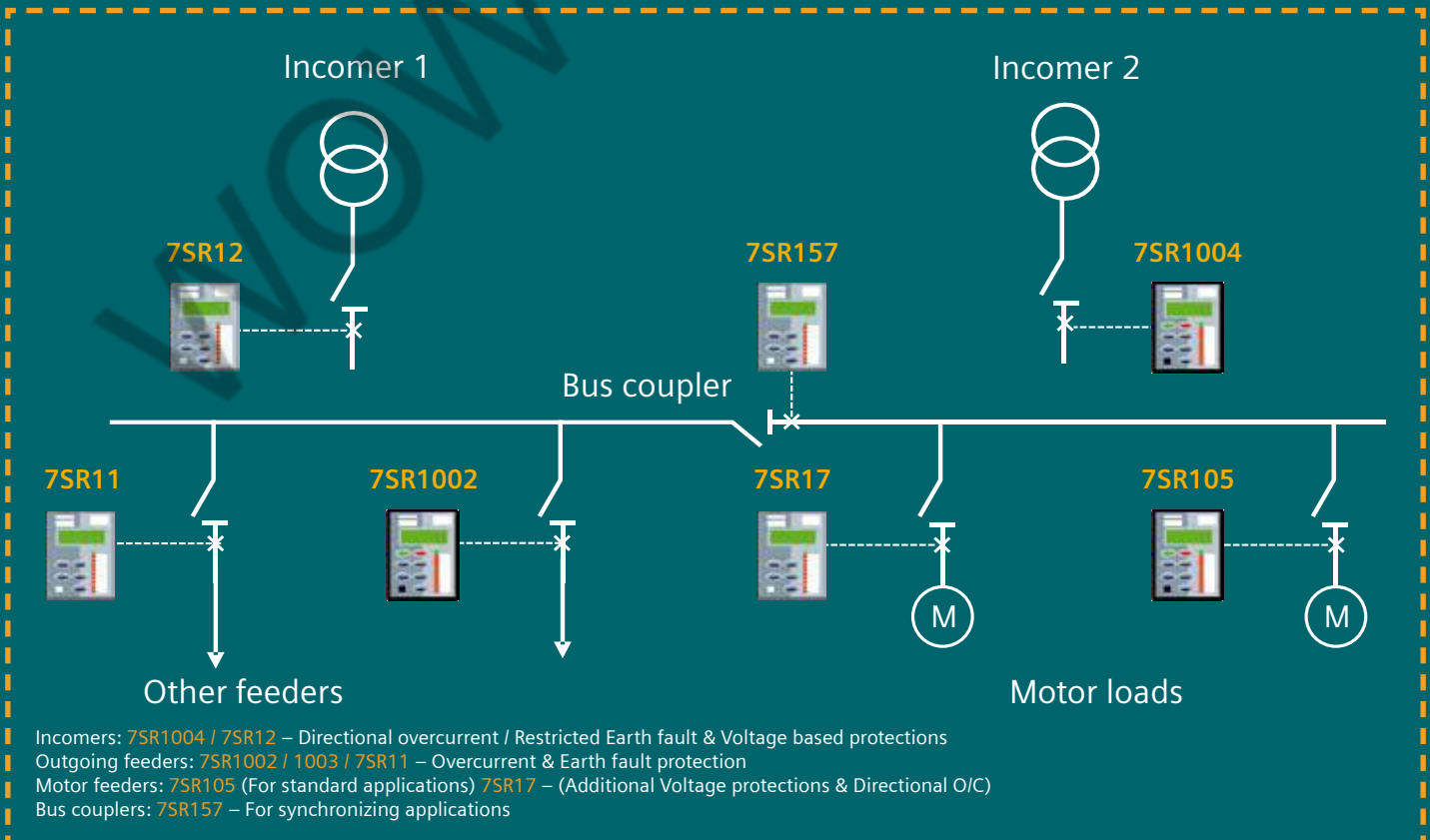

# 7SR Numerical Relays

		Description	Type *	Unit LP ₹
Feeder Protection		<b>Non Drawout   Non Directional</b> overcurrent relay   6 BI 6 BOs   <b>Measuring current input:</b> 1/5A   <b>Auxiliary voltage:</b> 60 to 240V AC/DC   <b>BI Threshold:</b> 44V AC/DC   <b>Communication:</b> Front USB, RS485 supporting IEC 60870-5-103 /Modbus RTU/DNP 3.0 <b>Protection Functions:</b> 46BC, 46NPS, 49, 50, 51, 50G/N, 51G/N, 50/51 SEF, 74T/CCS, 81THD, 86	7SR1003-1LA20-2CA0	82290.-
		<b>Non Drawout   Directional</b> overcurrent relay   9 BI 6 BOs   <b>Measuring current input:</b> 1/5A with SEF input   <b>Auxiliary voltage:</b> 60 to 240V AC/DC   <b>BI Threshold:</b> 88V AC/DC   <b>Communication:</b> Front USB, RS485 supporting IEC 60870-5-103 /Modbus RTU/DNP 3.0 <b>Protection Functions:</b> 27/59, 32, 32S, 37, 46BC, 46NPS, 47NPS, 49, 50BF, 51V, 55, 59N, 60CTS, 60VTS, 64H, 67/50, 50SEF, 51G/N, 51SEF, 74T/CCS, 81U/O	7SR1004-4KA20-2CA0	142575.-
		<b>Drawout   Non Directional</b> overcurrent relay   6 BI 8 BOs   <b>Measuring current input:</b> 1/5A with SEF input   <b>Auxiliary voltage:</b> 100 to 230V AC/24 -250VDC   <b>BI Threshold:</b> 19VDC   <b>Communication:</b> Front USB, RS485 supporting IEC 60870-5-103 /Modbus RTU/DNP 3.0 <b>Protection Functions:</b> 46BC, 46NPS, 49, 50, 50AFD, 50BF, 51, 50G/N, 51G/N, 64H, 74T/CCS, 86	7SR1103-1MA12-1CA0	138930.-
		<b>Drawout   Directional</b> overcurrent relay   6 BI 8 BOs   <b>Measuring current input:</b> 1/5A   <b>Auxiliary voltage:</b> 100 to 230V AC/24 -250VDC   <b>BI Threshold:</b> 19VDC   <b>Communication:</b> Front USB, RS485 supporting IEC 60870-5-103 /Modbus RTU/DNP 3.0 <b>Protection Functions:</b> 27, 59, 32, 32S, 37, 46BC, 46NPS, 47, 49, 50, 50AFD, 50BF, 51, 50N, 51N, 51V, 55, 59N, 60CTS, 64H, 67, 74T/CCS, 81U/O, 86	7SR1206-2MA12-1CA0	154970.-
Motor Protection		<b>Non Drawout   Motor Protection Relay</b>   6 BI 6 BOs   <b>Measuring current input:</b> 1/5A   <b>Auxiliary voltage:</b> 60 to 240V AC/DC   <b>BI Threshold:</b> 44V AC/DC   <b>Communication:</b> Front USB, RS485 supporting IEC 60870-5-103 /Modbus RTU/DNP 3.0 <b>Protection Functions:</b> 14, 37, 46, 46PhRev, 48/66, 49, 50/51, 50G/N, 51G/N, 50BCL, 50BF, 74T/CCS, 81B	7SR1053-2LA21-2EA0	119445.-
		<b>Drawout   Motor Protection Relay</b>   3 BI 5 BOs   <b>Measuring current input:</b> 1/5A with SEF input   <b>Auxiliary voltage:</b> 100 to 230V AC/24 -250VDC   <b>BI Threshold:</b> 19VDC   <b>Communication:</b> Front USB, RS485 supporting IEC 60870-5-103 /Modbus RTU/DNP 3.0 <b>Protection Functions:</b> 14, 37, 46, 46PhRev, 48/66, 49, 50, 51, 50G/N, 51G/N, 50BF, 50BCL, 60CTS, 74T/CCS, 81B	7SR1702-3MA12-1CA0	184345.-
		<b>Drawout   Motor Protection Relay</b>   6 BI 8 BOs 4CT 3VT   <b>Measuring current input:</b> 1/5A with SEF input   <b>Auxiliary voltage:</b> 100 to 230V AC/24 -250VDC   <b>BI Threshold:</b> 19VDC   <b>Communication:</b> Front USB, RS485 supporting IEC 60870-5-103 /Modbus RTU/DNP 3.0 <b>Protection Functions:</b> 14, 37, 46, 46PhRev, 48/66, 49, 50, 51, 50G/N, 51G/N, 50BF, 50BCL, 60CTS, 74T/CCS, 81B, 27/59, 32/55, 47, 60CTS, 60VTS, 67/50, 67/51, 67G/N, 81	7SR1706-4MA12-1CA0	196640.-
Transformer Protection		<b>Drawout   Transformer Protection Relay</b>   9 BI 6 BOs 8CT 1VT   <b>Measuring current input:</b> 1/5A   <b>Auxiliary voltage:</b> 100 to 230V AC/24 -250VDC   <b>BI Threshold:</b> 19VDC   <b>Communication:</b> Front USB, RS485 supporting IEC 60870-5-103 /Modbus RTU/DNP 3.0 <b>Protection Functions:</b> 81HBL2, 81HBL5, 87BD, 87HS, 49, 50, 51, 50G/N, 51G/N, 50BF, 64H, 74TCS/CCS, 37/37G, 46BC, 46NPS	7SR2422-2MA12-0BA0	410380.-

\* For more options on control voltage, BI/BOs, Communication protocols or protection functions please contact your nearest Siemens Sales Office

# 7PJ Auxiliary & Trip Relays

		Description	Type	Unit LP ₹
Aux Relays		Auxiliary relay Single Element with self reset contacts with flag, 110V DC, 3NO+2CO, Low burden	7PJ1111-6DA20-0AA0	10565.-
		Auxiliary relay Single Element with self reset contacts with flag, 220V DC, 3NO+2CO, Low burden	7PJ1111-7DA20-0AA0	10565.-
		Auxiliary relay Single Element with self reset contacts without flag, 110V DC, 3NO+2CO, Low burden	7PJ1114-6DA20-0AA0	10565.-
		Auxiliary relay Single Element with self reset contacts without flag, 220V DC, 3NO+2CO, Low burden	7PJ1114-7DA20-0AA0	10565.-
		Auxiliary relay Three Element, hand reset with flag, 110V DC, 2NO, Low burden	7PJ1132-6CA00-0AA0	21220.-
		Auxiliary relay Three Element, hand reset with flag, 220V DC, 2NO, Low burden	7PJ1132-7CA00-0AA0	21220.-
Trip Relays		Trip relay with hand reset contacts with flag, DC 110V, 4NO+1NC, high burden	7PJ1212-6EB01-0AA0	10565.-
		Trip relay with hand reset contacts with flag, DC 220V, 4NO+1NC, high burden	7PJ1212-7EB01-0AA0	10565.-
		TCS relay, 2CO, SR, Aux 24-240VAC/DC, BI 24-240VDC	7PJ1321-5AA21-0AA0	19380.-

## 7XJ Arc Protection systems



## For more information on Siemens Numerical Relays



\* LP - List Price Std Pkg = 1unit

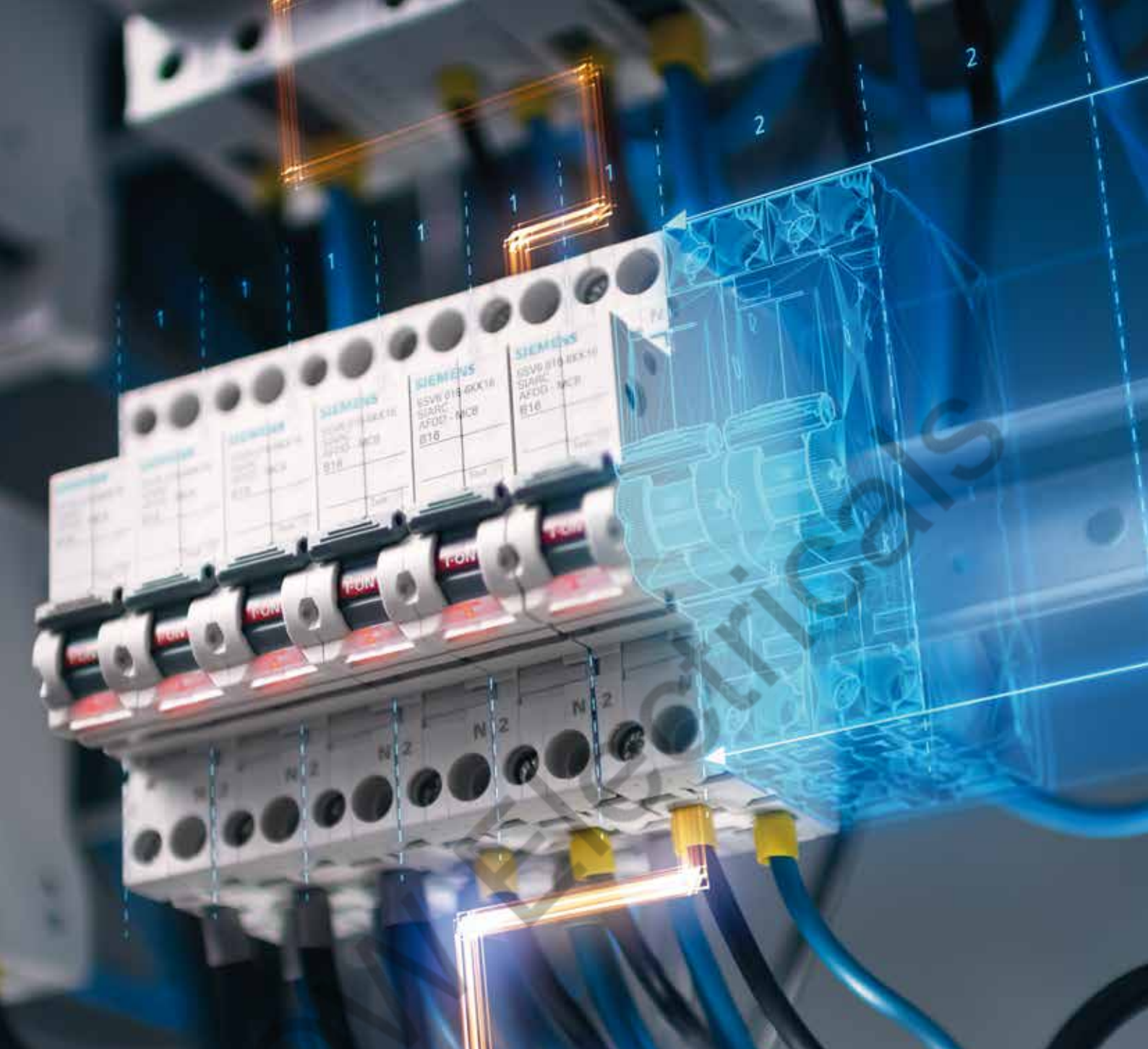

# Reliable protection by preventing electrical fires

## With Arc Fault Detection Device

With the 5SV6 Arc Fault Detection Device (AFDD), Siemens presents the third generation of fire-prevention product. The 5SV6 Arc Fault Detection Device with integrated miniature circuit breaker (MCB) and residual current breaker operator (RCBO) is the first device on the IEC market with just one module width and is the smallest of its kind worldwide.





A standard-compliant expansion of the electrical installation by protection against electrical fires is thus always possible – easily and without the need for additional space.

[www.siemens.com/AFDD](http://www.siemens.com/AFDD)

# Betagard Miniature Circuit Breakers Type 5SL6 and 5SL4



- Standards: IS/IEC 60898-1:2002
- Voltage: Un 240/415V, 50...60Hz can be used in systems upto 60V DC for 1P and 110V DC for 2P\*
- With ISI marking: CML No. 2255548

	I <sub>n</sub> A	MW#	7500A		10000A	Std. Pkg. (Nos.)
			Characteristic B	Characteristic C		
1P, 240/415 V AC  	0.5	1	--	5SL61057RC	5SL41057RC	1/12
	1		--	5SL61017RC	--	1/12
	2		--	5SL61027RC	5SL41027RC	1/12
	3		--	5SL61037RC	5SL41037RC	1/12
	4		--	5SL61047RC	5SL41047RC	1/12
	6		5SL61066RC	5SL61067RC	5SL41067RC	1/12
	8		--	5SL61087RC	5SL41087RC	1/12
	10		5SL61106RC	5SL61107RC	5SL41107RC	1/12
	13		--	5SL61137RC	5SL41137RC	1/12
	16		5SL61166RC	5SL61167RC	5SL41167RC	1/12
	20		5SL61206RC	5SL61207RC	5SL41207RC	1/12
	25		5SL61256RC	5SL61257RC	5SL41257RC	1/12
	32		5SL61326RC	5SL61327RC	5SL41327RC	1/12
	40		5SL61406RC	5SL61407RC	5SL41407RC	1/12
	50		5SL61506RC	5SL61507RC	5SL41507RC	1/12
63	5SL61636RC	5SL61637RC	5SL41637RC	1/12		
2P, 415 V AC  	0.5	2	--	5SL62057RC	5SL42057RC	1/6
	1		--	5SL62017RC	--	1/6
	2		--	5SL62027RC	5SL42027RC	1/6
	3		--	5SL62037RC	5SL42037RC	1/6
	4		--	5SL62047RC	5SL42047RC	1/6
	6		5SL62066RC	5SL62067RC	5SL42067RC	1/6
	8		--	5SL62087RC	5SL42087RC	1/6
	10		5SL62106RC	5SL62107RC	5SL42107RC	1/6
	13		--	5SL62137RC	5SL42137RC	1/6
	16		5SL62166RC	5SL62167RC	5SL42167RC	1/6
	20		5SL62206RC	5SL62207RC	5SL42207RC	1/6
	25		5SL62256RC	5SL62257RC	5SL42257RC	1/6
	32		5SL62326RC	5SL62327RC	5SL42327RC	1/6
	40		5SL62406RC	5SL62407RC	5SL42407RC	1/6
	50		5SL62506RC	5SL62507RC	5SL42507RC	1/6
63	5SL62636RC	5SL62637RC	5SL42637RC	1/6		
3P, 415 V AC  	0.5	3	--	5SL63057RC	5SL43057RC	1/4
	1		--	5SL63017RC	--	1/4
	2		--	5SL63027RC	5SL43027RC	1/4
	3		--	--	5SL43037RC	1/4
	4		--	5SL63047RC	5SL43047RC	1/4
	6		5SL63066RC	5SL63067RC	5SL43067RC	1/4
	8		--	--	5SL43087RC	1/4
	10		5SL63106RC	5SL63107RC	5SL43107RC	1/4
	13		--	--	5SL43137RC	1/4
	16		5SL63166RC	5SL63167RC	5SL43167RC	1/4
	20		5SL63206RC	5SL63207RC	5SL43207RC	1/4
	25		5SL63256RC	5SL63257RC	5SL43257RC	1/4
	32		5SL63326RC	5SL63327RC	5SL43327RC	1/4
	40		5SL63406RC	5SL63407RC	5SL43407RC	1/4
	50		5SL63506RC	5SL63507RC	5SL43507RC	1/4
63	5SL63636RC	5SL63637RC	5SL43637RC	1/4		
4P, 415 V AC  	0.5	4	--	5SL64057RC	5SL44057RC	1/3
	1		--	5SL64017RC	--	1/3
	2		--	5SL64027RC	5SL44027RC	1/3
	3		--	--	5SL44037RC	1/3
	4		--	5SL64047RC	5SL44047RC	1/3
	6		5SL64066RC	5SL64067RC	5SL44067RC	1/3
	8		--	--	5SL44087RC	1/3
	10		5SL64106RC	5SL64107RC	5SL44107RC	1/3
	13		--	--	5SL44137RC	1/3
	16		5SL64166RC	5SL64167RC	5SL44167RC	1/3
	20		5SL64206RC	5SL64207RC	5SL44207RC	1/3
	25		5SL64256RC	5SL64257RC	5SL44257RC	1/3
	32		5SL64326RC	5SL64327RC	5SL44327RC	1/3
	40		5SL64406RC	5SL64407RC	5SL44407RC	1/3
	50		5SL64506RC	5SL64507RC	5SL44507RC	1/3
63	5SL64636RC	5SL64637RC	5SL44637RC	1/3		

# 1 MW (Module Width) = 18 mm \* subject to application specific circuit connections. Please contact your nearest Siemens Sales Office.

Refer latest Electrical Installations from A to Z Price List for prices

Miniature Circuit Breakers



# Betagard Circuit Breakers

## 5SL7 Miniature circuit breaker

- Standards: IS/IEC 60898-1
- Voltage: Un 240/415V, 50...60Hz
- Breaking capacity: upto 15kA
- With ISI marking: CM/L No. 2255548



## 5SL5 Circuit Breakers

- Standards: IS/IEC 60947-2
- Voltage: 220V DC/1P & 440VDC/2P
- Breaking capacity: 10kA as per IS/IEC 60947-2

	Rated current I <sub>n</sub> (A)	MW#	10000A				Std. Pkg. (Nos)	
				Characteristic C	Characteristic D	Characteristic C, DC		
	0.5	1	1P, 240/415V AC	5SL71057RC	5SL71058RC	1P, 220V DC	5SL51057RC	1/12
	1			5SL71017RC	5SL71018RC		5SL51017RC	1/12
	2			5SL71027RC	5SL71028RC		5SL51027RC	1/12
	3			--	--		5SL51037RC	1/12
	4			5SL71047RC	5SL71048RC		5SL51047RC	1/12
	6			5SL71067RC	5SL71068RC		5SL51067RC	1/12
	8			--	--		5SL51087RC	1/12
	10			5SL71107RC	5SL71108RC		5SL51107RC	1/12
	16			5SL71167RC	5SL71168RC		5SL51167RC	1/12
	20			5SL71207RC	5SL71208RC		5SL51207RC	1/12
	25			5SL71257RC	5SL71258RC		5SL51257RC	1/12
	32			5SL71327RC	5SL71328RC		5SL51327RC	1/12
	40			5SL71407RC	5SL71408RC		5SL51407RC	1/12
	50			5SL71507RC	5SL71508RC		5SL51507RC	1/12
63	5SL71637RC	5SL71638RC	5SL51637RC	1/12				
	0.5	2	2P, 415V AC	5SL72057RC	5SL72058RC	2P, 440V DC	5SL52057RC	1/6
	1			5SL72017RC	5SL72018RC		5SL52017RC	1/6
	2			5SL72027RC	5SL72028RC		5SL52027RC	1/6
	3			--	--		5SL52037RC	1/6
	4			5SL72047RC	5SL72048RC		5SL52047RC	1/6
	6			5SL72067RC	5SL72068RC		5SL52067RC	1/6
	8			--	--		5SL52087RC	1/6
	10			5SL72107RC	5SL72108RC		5SL52107RC	1/6
	16			5SL72167RC	5SL72168RC		5SL52167RC	1/6
	20			5SL72207RC	5SL72208RC		5SL52207RC	1/6
	25			5SL72257RC	5SL72258RC		5SL52257RC	1/6
	32			5SL72327RC	5SL72328RC		5SL52327RC	1/6
	40			5SL72407RC	5SL72408RC		5SL52407RC	1/6
	50			5SL72507RC	5SL72508RC		5SL52507RC	1/6
63	5SL72637RC	5SL72638RC	5SL52637RC	1/6				
	0.5	3	3P, 415V AC	5SL73057RC	5SL73058RC	--	--	1/4
	1			5SL73017RC	5SL73018RC		--	1/4
	2			5SL73027RC	5SL73028RC		--	1/4
	4			5SL73047RC	5SL73048RC		--	1/4
	6			5SL73067RC	5SL73068RC		--	1/4
	10			5SL73107RC	5SL73108RC		--	1/4
	16			5SL73167RC	5SL73168RC		--	1/4
	20			5SL73207RC	5SL73208RC		--	1/4
	25			5SL73257RC	5SL73258RC		--	1/4
	32			5SL73327RC	5SL73328RC		--	1/4
	40			5SL73407RC	5SL73408RC		--	1/4
	50			5SL73507RC	5SL73508RC		--	1/4
	63			5SL73637RC	5SL73638RC		--	1/4
				0.5	4		4P, 415V AC	5SL74057RC
1		5SL74017RC	5SL74018RC	--		1/3		
2		5SL74027RC	5SL74028RC	--		1/3		
4		5SL74047RC	5SL74048RC	--		1/3		
6		5SL74067RC	5SL74068RC	--		1/3		
10		5SL74107RC	5SL74108RC	--		1/3		
16		5SL74167RC	5SL74168RC	--		1/3		
20		5SL74207RC	5SL74208RC	--		1/3		
25		5SL74257RC	5SL74258RC	--		1/3		
32		5SL74327RC	5SL74328RC	--		1/3		
40		5SL74407RC	5SL74408RC	--		1/3		
50		5SL74507RC	5SL74508RC	--		1/3		
63		5SL74637RC	5SL74638RC	--		1/3		

# 1 MW (Module Width) = 18 mm

Refer latest Electrical Installations from A to Z Price List for prices



# | Geared to act *FAST!*

## Siemens range of fuses

Fuses are the fastest & simplest current limiting devices, suitable for protection of lines, systems, devices in both distribution & control circuits.

Available in varied design - with a wide current range, multiple voltage ratings and high short circuit strength. Our fuses are perfectly equipped to minimize the effect of over currents, thus allowing you to protect property as well as lives.

Siemens Fuses offer:

- High switching capacity
- Compact Design
- Low Watt Losses

With Siemens fuses - protection is Easy, Safe and Reliable

[www.siemens.com/fuses](http://www.siemens.com/fuses)

**SIEMENS**

# HRC fuses (DIN) 3NA

- High Breaking capacity of 120kA
- Dual indication for fault detection
- CE marked
- Highly compact: upto 100A in size 000



## Upto 800A, 500V AC, S.C. breaking capacity 120kA

Size	Rated current (A)	Type	Unit MRP <sup>®</sup> ₹	Std. pkg.** (nos.)
000	2	3NA78020RC	470.-	1/6
	4	3NA78040RC	470.-	1/6
	6	3NA78010RC	470.-	1/6
	10	3NA78030RC	470.-	1/6
	16	3NA78050RC	475.-	1/6
	20	3NA78070RC	475.-	1/6
	25	3NA78100RC	475.-	1/6
	32	3NA78120RC	475.-	1/6
	40	3NA78170RC	500.-	1/6
	50	3NA78200RC	500.-	1/6
	63	3NA78220RC	555.-	1/6
	80	3NA78240RC	605.-	1/6
	100	3NA78300RC	605.-	1/6
	00	125	3NA78320RC	730.-
160		3NA78360RC	770.-	1/6
50		3NA71200RC	1035.-	1/3
63		3NA71220RC	1035.-	1/3
1	80	3NA71240RC	1035.-	1/3
	100	3NA71300RC	1035.-	1/3
	125	3NA71320RC	1080.-	1/3
	160	3NA71360RC	1115.-	1/3
	200	3NA71400RC	1115.-	1/3
	224	3NA71420RC	1155.-	1/3
	250	3NA71440RC	1250.-	1/3
	200	3NA72400RC	1540.-	1/3
2	250	3NA72440RC	1600.-	1/3
	315	3NA72520RC	1655.-	1/3
	400*	3NA72600RC	1655.-	1/3
3	315	3NA33520RC	2355.-	1/3
	400	3NA33600RC	2355.-	1/3
	500	3NA33650RC	2635.-	1/3
	630	3NA33720RC	2695.-	1/3
	800*	3NA33754RC	3280.-	1/3

\* 400A (Size II) and 800A are rated at 415V AC

## 690V AC, S.C. breaking capacity 120kA

Size	Rated current (A)	Type	Unit MRP <sup>®</sup> ₹	Std. pkg.** (nos.)
00	40	3NA78176RC	680.-	1/6
	50	3NA78206RC	680.-	1/6
	63	3NA78226RC	730.-	1/6
	80	3NA78246RC	770.-	1/6
1	100	3NA78306RC	770.-	1/6
	125	3NA71326RC	1330.-	1/3
	160	3NA71366RC	1380.-	1/3
2	200	3NA71406RC	1380.-	1/3
	250	3NA72446RC	1825.-	1/3
3	315	3NA72526RC	1960.-	1/3
	400	3NA33606RC	2925.-	1/3
	425	3NA33626RC	2925.-	1/3
500	3NA33656RC	3125.-	1/3	

## Isolating links (DIN)

Size	Rated current (A)	Type	Unit MRP <sup>®</sup> ₹	Std. pkg.** (nos.)
00	160	■ 3NG1000	525.-	1
1	250	■ 3NG1250	790.-	1
2	400	■ 3NG1300	1290.-	1
3	630	■ 3NG1400	1335.-	1



## Fuse bases (DIN)

Size	Rated current (A)	Suitable for fuse link type	Type	Unit MRP <sup>®</sup> ₹	Std. pkg.** (nos.)
00/000	160	3NA7 8	■ 3NH3030-0RC (Screw-in)	640.-	1/10
00/000	160	3NA7 8	■ 3NH3032-0RC (Plug in)	680.-	1/10
1	250	3NA7 1	■ 3NH3230-0RC	1280.-	1/5
2	400	3NA7 2	■ 3NH3330-0RC	1810.-	1/5
3	630	3NA3 3	■ 3NH3430-0RC	2610.-	1/5
3	800	3NA3 3	■ 3NH3430-4RC	3090.-	1/5



## Fuse puller

Description	Type	Unit MRP <sup>®</sup> ₹	Std. pkg.** (nos.)
Suitable for 3KL8 and all sizes of fuse links/isolating links	■ 3NX1011	3130.-	1
Suitable only for fuse links and isolating links	3NX1010	1305.-	1



## LV HRC contact covers

Size	Type	Unit LP* ₹	Std. pkg.** (nos.)
00/000	3NX3115	700.-	1/10
00/000	3NX3116	435.-	1/10



Note: Prices on request for Touch protection of contact pieces of all sizes

## Fuse & Fuse base for 1000A/1250A (IEC design)

Size	Rating	Type	Unit LP* ₹	Std. pkg.** (nos.)
4	1000A	3NA3480	POR	1/1
4	1250A	3NA3482		1/1
4	1250A	3NH3530 Fuse base		1/1



## 690V AC, S.C. breaking capacity 120kA

Size	Rated current (A)	Type	Unit LP* ₹
000	2A	3NA78026	POR
	4A	3NA78046	
	6A	3NA78016	
	10A	3NA78036	
	16A	3NA78056	
	20A	3NA78076	
	25A	3NA78106	
	32A	3NA78126	
	35A	3NA78146	

\*\* Purchase MOQ for our authorised dealers is in multiples of standard packing, please contact your nearest Siemens Sales Office for further details  
 POR: Price On Request

■ Stock items \* LP - List Price © MRP - Max. Retail Price



# SENTRON 3NA COM LV HRC fuse link – safety through transparency

Optimize the operation of your plants with consistent data that's constantly available when and where you need it – whether in the cloud using higher-level analysis tools, via a PC using the SENTRON power manager power monitoring software, or directly at the plant via a mobile device using the SENTRON power config mobile app.

In the event of a fault, detecting and locating power failures are time-consuming and costly. Smart local grids are only as smart as their individual components. The measurement and communication-capable 3NA COM LV HRC fuse link makes transformer substations smart and enables them to be integrated in digital systems.

Communication Capable Fuse Link offers:

- Transparency for the local grid transformer station
- Easy retrofit
- Powerful interface for digitalization
- Sustainable and robust design

With Siemens fuses - protection is Easy, Safe and Reliable

[www.siemens.com/fuses](http://www.siemens.com/fuses)

**SIEMENS**

# HRC fuses (BS) 3NW

- 2A-800A
- Rated at 415V AC/240V DC
- Breaking capacity 80kA (AC)



## Blade tag

Rated current A	Type	Unit MRP* ₹	Std. pkg.** (nos.)
2	■ 3NWNS2	125.-	20
4	■ 3NWNS4	125.-	20
6	■ 3NWNS6	125.-	20
10	■ 3NWNS10	125.-	20
16	■ 3NWNS16	125.-	20
20	■ 3NWNS20	150.-	20
25	■ 3NWNS25	150.-	20
32	■ 3NWNS32	150.-	20

## Offset tag

Rated current A	Type	Unit MRP* ₹	Std. pkg.** (nos.)
2	3NWTIA2	180.-	20
4	3NWTIA4	180.-	20
6	3NWTIA6	180.-	20
10	■ 3NWTIA10	200.-	20
16	■ 3NWTIA16	200.-	20
20	■ 3NWTIA20	200.-	20
25	■ 3NWTIA25	200.-	20
32	■ 3NWTIA32	200.-	20
40	3NWTIS40	275.-	20
50	■ 3NWTIS50	275.-	20
63	■ 3NWTIS63	275.-	20
80	3NWTCP80	715.-	10
100	■ 3NWTCP100	715.-	10
125	3NWTFP125	1450.-	5
160	3NWTFP160	1450.-	5
200	3NWTFP200	1450.-	5

## Central tag

Rated current A	Type	Unit MRP* ₹	Std. pkg.** (nos.)
80	3NWTTC80	765.-	10
100	3NWTTC100	765.-	10
125	3NWTFC125	1585.-	5
160	3NWTFC160	1585.-	5
200	3NWTFC200	1585.-	5
250	3NWTKF250	2185.-	1
315	3NWTKF315	2185.-	1
355	3NWTMF355	2545.-	1
400	3NWTMF400	2545.-	1
500	3NWTTM500	4010.-	1
630	3NWTTM630	4880.-	1
710	3NWTLM710	5575.-	1
800	3NWTLM800	5575.-	1

## Offset tag

Rated current A	Type	Unit MRP* ₹	Std. pkg.** (nos.)
6	3NWTSA6	150.-	20
10	3NWTSA10	150.-	20
16	3NWTSA16	150.-	20
20	3NWTSA20	150.-	20
25	3NWTSA25	150.-	20
32	3NWTSA32	150.-	20
36	3NWTSS36	300.-	20
40	3NWTSS40	300.-	20
50	3NWTSS50	300.-	20
63	3NWTSS63	300.-	20
80	3NWTSDS80	565.-	20
100	3NWTSDS100	565.-	20
125	3NWTSP125	710.-	5
160	3NWTSP160	770.-	5
200	3NWTSP200	710.-	5

## Central tag

Rated current A	Type	Unit MRP* ₹	Std. pkg.** (nos.)
80	3NWTSDC80	680.-	10
100	3NWTSDC100	680.-	10
125	3NWTSF125	715.-	5
160	3NWTSF160	715.-	5
200	3NWTSF200	715.-	5
250	3NWTSK250	1715.-	1
315	3NWTSK315	1715.-	1
355	3NWTSM355	2860.-	1
400	3NWTSM400	2860.-	1
450	3NWTST450	2375.-	1
500	3NWTST500	2375.-	1
560	3NWTSL560	4535.-	1
630	3NWTSL630	3840.-	1
800	3NWTSL800	5545.-	1

## Fuse holders (for fuses type 3NW TIA, TSA, TIS, TSS, TSDS)

Rated current A	Type	Unit MRP* ₹	Std. pkg.** (nos.)
32	3NWC32F9	2750.-	10
63	3NWC63F9	3230.-	10
100	3NWC100F9	3560.-	10

## Fuse holders (for fuses Type 3NW NS) & Isolating link

Rated current A	Type	Unit MRP* ₹	Std. pkg.** (nos.)
20	■ 3NW20NSF	295.-	10
32	■ 3NW32NSF	370.-	10
32A (Iso. Link)	■ 3NW32NSL	160.-	10

\*\* Purchase MOQ for our authorised dealers is in multiples of standard packing, please contact your nearest Siemens Sales Office for further details

### ■ Stock items

\* MRP - Maximum Retail Price

Please order in multiples of standard packing.

# Fuses for semiconductor protection - SITOR 3NE / 3NC

- Current Range upto 2400A
- Operating voltage: 500V - 2500V AC
- Suitable for mounting in fuse base / SDF / busbars

## 3NE4 type

Rated voltage V	Rated current (A)	Type	Utilization category	DIN size	Unit LP* ₹	Std. pkg.** (nos.)
1000	32	3NE4101	gR	1	3140.-	1
	40	3NE4102	gR	1	3150.-	1
	50	3NE4117	gR	1	3310.-	1
	80	3NE4120	aR	1	3575.-	1
	100	3NE4121	aR	1	3920.-	1
	125	3NE4122	aR	1	4210.-	1
	160	3NE4124	aR	1	4635.-	1

Rated voltage V	Rated current (A)	Type	Utilization category	DIN size	Unit LP* ₹	Std. pkg.** (nos.)
800	250	3NE43276	aR	-	8345.-	1
	315	3NE43306	aR	-	8615.-	1
	450	3NE43336	aR	-	9005.-	1
	500	3NE43346	aR	-	9080.-	1
	710	3NE43376	aR	-	10155.-	1

## 3NE8 type<sup>1)</sup> 690 V AC

NEW

Rated current (A)	Type	Utilization category	Size	Unit LP* ₹	Std. pkg.** (nos.)
25	3NE80151	gR	00	6660.-	3
35	3NE80031	gR	00	6660.-	3
50	3NE80171	gR	00	6660.-	3
63	3NE80181	gR	00	6660.-	3
80	3NE80201	aR	00	7390.-	3
100	3NE80211	aR	00	7735.-	3
125	3NE80221	aR	00	7850.-	3
160	3NE80241	aR	00	8615.-	3
200	3NE12252	gR	1	21795.-	3
250	3NE12272	gR	1	22535.-	3
315	3NE12302	gR	1	23310.-	3
350	3NE13312	gR	2	30850.-	3
400	3NE13322	gR	2	39620.-	3
450	3NE13332	gR	2	33150.-	3
500	3NE13342	gR	2	34455.-	3
560	3NE14352	gR	3	42810.-	3
630	3NE14362	gR	3	44415.-	3
670	3NE14472	gR	3	45390.-	3
710	3NE14372	gR	3	47330.-	3
800	3NE14382	gR	3	50865.-	3
850	3NE14482	gR	3	55365.-	3

Note: For current ratings > 1600A ,Operating voltage > 2000V AC please contact your nearest Siemens Sales Office.

<sup>1)</sup> Suitable for mounting on fuse base / 3KL8 / 3NP1

\*\* Purchase MOQ for our authorised dealers is in multiples of standard packing, please contact your nearest Siemens Sales Office for further details

■ Stock items

\* LP - List Price

Please order in multiples of standard packing.

## 3NE9 type 600 V AC

Rated current (A)	Type	Utilization category	Size	Unit LP* ₹	Std. pkg.** (nos.)
850	3NE94406	gR	-	37180.-	3
1250	3NE9450	aR	-	35040.-	3

## 3NE1 type<sup>1)</sup> 690 V AC

Rated current (A)	Type	Utilization category	DIN Size	Unit LP* ₹	Std. pkg.** (nos.)
16	3NE18130	gS	000	7850.-	3
20	3NE18140	gS	000	7850.-	3
25	3NE18150	gS	000	7850.-	3
35	3NE18030	gS	000	7850.-	3
40	3NE18020	gS	000	7850.-	3
50	3NE18170	gS	000	7850.-	3
63	3NE18180	gS	000	7850.-	3
80	3NE18200	gS	000	7850.-	3
100	3NE10210	gS	00	10135.-	3
125	3NE10220	gS	00	10135.-	3
160	3NE12240	gS	1	23955.-	3
200	3NE12250	gS	1	23955.-	3
250	3NE12270	gS	1	25155.-	3
315	3NE12300	gS	1	26975.-	3
350	3NE13310	gS	2	33495.-	3
400	3NE13320	gS	2	33785.-	3
450	3NE13330	gS	2	33995.-	3
500	3NE13340	gS	2	34505.-	3
560	3NE14350	gS	3	34695.-	3
630	3NE14360	gS	3	36195.-	3
710	3NE14370	gS	3	38625.-	3
800	3NE14380	gS	3	44105.-	3

## 3NE8 type 690 V AC / 700V DC

Rated current (A)	Type	Utilization category	Size	Unit LP* ₹	Std. pkg.** (nos.)
20	3NE87141	gR	000	POR	10
25	3NE87151	gR	000		10
32	3NE87011	gR	000		10
40	3NE87021	gR	000		10
50	3NE87171	gR	000		10
63	3NE87181	aR	000		10
80	3NE87201	aR	000		10
100	3NE87211	aR	000		10
125	3NE87221	aR	000		10
160	3NE87241	aR	000		10
200	3NE87251	aR	000		10
250	3NE87271	aR	000		10
315	3NE87311	aR	000		10

# Fuses for semiconductor protection - SITOR 3NE / 3NC



**3NE3 type**  
1000 V AC

Rated current (A)	Type	Utilization category	DIN Size	Unit LP* ₹	Std. pkg.** (nos.)
100	3NE3221	aR	1	17840.-	3
125	3NE3222	aR	1	18355.-	3
160	3NE3224	aR	1	18355.-	3
200	3NE3225	aR	1	20200.-	3
250	3NE3227	aR	1	20735.-	3
315	3NE32300B	aR	1	21590.-	3
350	3NE3231	aR	1	25630.-	3
400	3NE32320B	aR	1	27455.-	3
450	3NE3233	aR	1	28435.-	3
400	3NE33320B	aR	2	27720.-	3
450	3NE3333	aR	2	29190.-	3
500	3NE33340B	aR	2	29740.-	3
560	3NE3335	aR	2	30860.-	3
630	3NE3336	aR	2	32330.-	3
710*	3NE33378	aR	2	44275.-	3
800*	3NE33388	aR	2	45500.-	3
900*	3NE33408	aR	2	54200.-	3

Rated current (A)	Type	Utilization category	DIN Size	Unit LP* ₹	Std. pkg.** (nos.)
630	3NC33361U	aR	3	POR	1/3
710	3NC33371U	aR	3		1/3
800	3NC33381U	aR	3		1/3
900	3NC33401U	aR	3		1/3
1000	3NC33411U	aR	3		1/3
1100	3NC33421U	aR	3		1/3
1250	3NC33431U	aR	3		1/3

\* 710A: 900V AC; 800A: 800V AC; 900A: 690V AC



**3NC type**  
690V AC

Rated current (A)	Type	Utilization category	DIN Size	Unit LP* ₹	Std. pkg.** (nos.)
150	3NC84233C	gR	3	41025.-	3
200	3NC84253C	gR	3	28620.-	3
250	3NC84273C	gR	3	32730.-	3
350	3NC84313C	gR	3	33745.-	3
500	3NC84343C	gR	3	36465.-	3
1000*	3NC84443C	aR	3	66265.-	3

\* 1000A, 600V AC



**3NE5 type**  
1500 V AC

Rated current (A)	Type	Utilization category	DIN Size	Unit LP* ₹	Std. pkg.** (nos.)
160	3NE54240C	aR	3	52385.-	2
224	3NE54260C	aR	3	57310.-	2
250	3NE56270C	aR	3	53165.-	3
315	3NE54300C	aR	3	54745.-	2
350	3NE54310C	aR	3	60090.-	2
450	3NE56330C	aR	3	59665.-	3
600	3NE56430C	aR	3	70995.-	3



**3NE7 type**  
2000 V AC

Rated current (A)	Type	Utilization category	DIN Size	Unit LP* ₹	Std. pkg.** (nos.)
200	3NE74250U	aR	3	POR	2
250	3NE74270U	aR	3		2
350	3NE74310U	aR	3		2
400	3NE74320U	aR	3		2
450	3NE76331U	aR	3		2
525	3NE76481U	aR	3		2
630	3NE76361U	aR	3		2
710	3NE76371U	aR	3		2

## Fuse bases for SITOR fuses

- With bolt-on links or slotted blade contacts
- 1-pole



Version mm	For fuse series	$I_n$ A	$U_n$ V AC / V DC	Con-nection bolt	Type	Unit LP* ₹	Std. pkg. (nos.)
75	3NC18	50	690	M5	3NH5723	POR	1/3
80	3NE87, 3NC26	315	690	M8	3NH5023		1/3
	3NE80...3MK	400	690	M10	3NH5323		1/3
	3NC32...-1U, 3NE82...-3MK	1600	690	M10	3NH5423		
110	3NC24, 3NC33...-1U, 3NC34...-1U, 3NC84, 3NE1...-3, 3NE32, 3NE33, 3NE34	1250	1250	M10	3NH5463		1/3
	170	3NE53, 3NE56	630	1800	M10		3NH5473

Utilization category as per VDE 0636/IEC 60269

Semiconductor aR, gR, gS  
Cable & Conductor gG  
Motor aM

1st letter

a = Partial range of protection (accompanied fuses)  
g = Complete range protection (general purpose fuses)

2nd letter

G(-L) = Cable & conductor protection (general purpose fuses)  
M = Motor protection  
R, S = Semiconductor protection

\*\* Purchase MOQ for our authorised dealers is in multiples of standard packing, contact Siemens Sales Office for further details

\* LP - List Price      POR: Price On Request

**Please order in multiples of standard packing.**

# Cylindrical Fuses (3NW)

- Rated current 0.5A-100A
- Breaking capacity 100kA
- Operational Class gG and aM



## Cylindrical Fuse, Size 10 x 38

Rated Current (A)	Size	Voltage (V)	Type	Unit LP* ₹	Std. pkg.** (nos.)		
0.5A	10 x 38	500	3NW60001	590.-	1/10		
1A			3NW60111	590.-	1/10		
2A			3NW60021	590.-	1/10		
4A			3NW60041	590.-	1/10		
6A			3NW60011	590.-	1/10		
8A			3NW60081	590.-	1/10		
10A			3NW60031	590.-	1/10		
12A			3NW60061	590.-	1/10		
16A			3NW60051	590.-	1/20		
20A			3NW60071	590.-	1/20		
25A			3NW60101	590.-	1/20		
32A			3NW60121	590.-	1/20		
			400				

## Cylindrical Fuse, Size 14 x 51

Rated Current (A)	Size	Voltage (V)	Type	Unit LP* ₹	Std. pkg.** (nos.)
4A	14 x 51	690	3NW61041	660.-	1/10
6A			3NW61011	660.-	1/10
8A			3NW61081	660.-	1/10
10A			3NW61031	660.-	1/10
12A			3NW61061	660.-	1/10
16A			3NW61051	660.-	1/10
20A			3NW61071	660.-	1/10
25A			3NW61101	660.-	1/10
32A			3NW61121	775.-	1/10
40A			3NW61171	775.-	1/10
50A	3NW61201	775.-	1/10		
	500				

## Cylindrical Fuse, Size 22 x 58

Rated Current (A)	Size	Voltage (V)	Type	Unit LP* ₹	Std. pkg.** (nos.)		
16A	22 x 58	690	3NW62051	1140.-	1/10		
20A			3NW62071	1140.-	1/10		
25A			3NW62101	1140.-	1/10		
32A			3NW62121	1140.-	1/10		
40A			3NW62171	1255.-	1/10		
50A			3NW62201	1255.-	1/10		
63A			3NW62221	1255.-	1/10		
80A			3NW62241	1255.-	1/10		
100A		3NW62301	1390.-	1/10			
		500					

## Cylindrical Fuse holders

No of Poles	Size	Rating (A)	MW	Type	Unit LP* ₹	Std. pkg.** (nos.)
1P	10 x 38	32A	1	3NW7013	1050.-	1/1
	14 x 51	50A	1.5	3NW7111	3345.-	1/1
	22 x 58	100A	2	3NW7211	5470.-	1/1
1+N	10 x 38	32A	1	3NW7053	2155.-	1/1
	14 x 51	50A	3	3NW7151	6925.-	1/1
	22 x 58	100A	4	3NW7251	11215.-	1/1
2P	10 x 38	32A	2	3NW7023	2110.-	1/1
	14 x 51	50A	3	3NW7121	6670.-	1/1
	22 x 58	100A	4	3NW7221	9445.-	1/1
3P	10 x 38	32A	3	3NW7033	3175.-	1/1
	14 x 51	50A	4.5	3NW7131	9995.-	1/1
	22 x 58	100A	6	3NW7231	14080.-	1/1

Note: Prices for 1+N and 3+N Fuse holder on request

\* LP - List Price

### Fuse Systems Available

1. Fuses for Photovoltaic application (DC 1000V / 1500V)
  2. NEOZED Fuses & Busbar system up to 100A
  3. Diazed fuse systems up to 63A
  4. Class CC UL fuse links up to 30A
- For more details please contact your nearest Siemens Sales Office.



### Fuses for Special Applications

1. Rectifiers in Electrolysis system
  2. SITOR 8QG 10/11 thyristor sets
  3. Mounting in railway supply rectifier
- For more details please contact your nearest Siemens Sales Office.







# 5SD Surge Protection Devices

## Safe & Reliable

Surge Protection Devices are available in the following types:

Type 1 - For incoming power supply panels, in buildings with lightning protection system. Must be accompanied by downstream SPD

Type 2 - For distribution panels located downstream of Type 1 protectors or in incoming supply panels in areas of low exposure to lightning strikes, where the building is not fitted with lightning protection system

Type 3 - Always installed downstream of Type 2 protection designed to protect sensitive equipment or equipment located more than 20m downstream of Type 2 SPD

[www.siemens.co.in](http://www.siemens.co.in)

**SIEMENS**



Licensed  
Partner

For  
SIEPAN 8PU

**SIEMENS**

# INDUSTRY 4.0

## Welcome to the world of digitalization with LV Panels

**Industry 4.0** is a name for the current trend of automation and data exchange in manufacturing technologies. It includes cyber-physical systems, the Internet of things, cloud computing and cognitive computing. Industry 4.0 creates what has been called a "smart factory".

SIEMENS LV Panels helps our customers stride into the new & exciting world of digitalization.

For more information call us on 1800 209 1800

For Life Cycle Support of Products, Systems and Solutions call us on 1800 209 0987

[www.siemens.com/sivacon-details](http://www.siemens.com/sivacon-details)

**SIEMENS**

# Fuseless selection Iq = 50 kA, IS/IEC:60947-4-1 (3VM with 3RT & 3RU)

Suitable for IE2 motors

- The selection is valid only for complete Siemens combinations i.e MCCB + Contactor + Birelay mentioned below.
- In case this combination is changed to accommodate another brand / rating of MCCB / contactor / birelay, it shall be the responsibility of the person making such a change to assure the coordination.
- Selection is for normal starting conditions with starting time ≤ 6 seconds. (For heavy starting applications e.g. ID/FD fans, reciprocating compressor, ball mills etc., please consult Siemens.)
- Magnetic setting of Circuit breaker to be done as per starting current of Motor
- For charts with 3VM MCCB for ratings below 75kW, please consult Siemens.
- **Recommended selection.**

## Direct-on-line feeder

kW 415V, 3ph, 50/60 Hz	Rated current IL (A)	Breaking Capacity Iq	Circuit Breaker		Contactor		Bi-relay	
			MCCB	Rated current In (A)	Type	Amp	Type	Range (A)
75	134	50kA	3VM1216-5MH32-0AA0	160	3RT1055	150	3RU2156-5DB10-8K	110 - 160
90	160	50kA	3VM1220-5MH32-0AA0	200	3RT1056	185	3RU2156-5EB10-8K	140 - 200
110	190	50kA	3VM1325-5MH32-0AA0	250	3RT1064	225	3RU2166-5FB10-8K	180 - 250
132	228	50kA	3VM1325-5MH32-0AA0	250	3RT1065	265	3RU2166-5GB10-8K	220 - 320
160	269	50kA	3VM1332-5MH32-0AA0	320	3RT1066	300	3RU2166-5GB10-8K	220 - 320
200	335	50kA	3VM1440-5MH32-0AA0	400	3RT1075	400	3RU2176-5HB10-8K	280 - 400
250	418	50kA	3VM1450-5MH32-0AA0	500	3RT1076	500	3RU2176-5JB10-8K	350 - 500

## Star-Delta feeder

kW 415V, 3ph, 50/60 Hz	Rated current IL (A)	Phase Current Iph (A)	Breaking Capacity Iq	Circuit Breaker		Contactor (Line/Delta)		Contactor (Star)		Bi-relay	
				MCCB	Rated current In (A)	Type	Amp	Type	Amp	Type	Range (A)
75	134	78	50kA	3VM1216-5MH32-0AA0	160	3RT1054	115	3RT2037	65	3RU2156-5BB10-8K	70 - 100
90	160	93	50kA	3VM1220-5MH32-0AA0	200	3RT1055	150	3RT2038	80	3RU2156-5BB10-8K	70 - 100
110	190	110	50kA	3VM1325-5MH32-0AA0	250	3RT1056	185	3RT2046	95	3RU2156-5CB10-8K	90 - 125
132	228	132	50kA	3VM1325-5MH32-0AA0	250	3RT1056	185	3RT1054	115	3RU2156-5DB10-8K	110 - 160
160	269	156	50kA	3VM1332-5MH32-0AA0	320	3RT1064	225	3RT1054	115	3RU2156-5EB10-8K	140 - 200
200	335	194	50kA	3VM1440-5MH32-0AA0	400	3RT1065	265	3RT1055	150	3RU2166-5FB10-8K	180 - 250
250	418	243	50kA	3VM1450-5MH32-0AA0	500	3RT1066	300	3RT1056	185	3RU2166-5GB10-8K	220 - 320

Note: For ratings below 75kW, with SCPD 3RV MPCB, please refer to Low Voltage Control Products Price List or please contact your nearest Siemens Sales Office.

# Fuseless selection Iq = 50 kA, IS/IEC:60947-4-1 (3VA with 3RT & 3RU)

Suitable for IE3 motors

- The selection is valid only for complete Siemens combinations i.e MCCB + Contactor + Birelay mentioned below.
- In case this combination is changed to accommodate another brand / rating of MCCB / contactor / birelay, it shall be the responsibility of the person making such a change to assure the coordination.
- Selection is for normal starting conditions with starting time ≤ 6 seconds. (For heavy starting applications e.g. ID/FD fans, reciprocating compressor, ball mills etc., please consult Siemens.)
- Ratio of starting current to rated current: In accordance to IS12615:2018
- Magnetic setting of Circuit breaker to be done as per starting current of Motor
- For charts with 3VA MCCB for ratings below 37kW, please consult Siemens.
- **Recommended selection.**

## Direct-on-line feeder

kW 415V, 3ph, 50/60 Hz	Rated current IL (A)	Breaking Capacity Iq	Circuit Breaker		Contactor		Bi-relay	
			MCCB	Rated current In (A)	Type	Rating (A)	Type	Range (A)
37	64	50kA	3VA1180-5MH32-0AA0	80	3RT2038	80	3RU2136-4KB0	62...73
45	77	50kA	3VA1110-5MH32-0AA0	100	3RT2046	95	3RU2146-4LB0	70...90
55	94	50kA	3VA1112-5MH32-0AA0	125	3RT1054	115	3RU2156-5CB10-8K	90...125
75	132	50kA	3VA1216-5MH32-0AA0	160	3RT1055	150	3RU2156-5DB10-8K	110-160
90	155	50kA	3VA1220-5MH32-0AA0	200	3RT1056	185	3RU2156-5EB10-8K	140-200
110	186	50kA	3VA1325-5MH32-0AA0	250	3RT1064	225	3RU2166-5EB10-8K	140-200
132	220	50kA	3VA1325-5MH32-0AA0	250	3RT1065	265	3RU2166-5FB10-8K	180-250
160	267	50kA	3VA1332-5MH32-0AA0	320	3RT1075	400	3RU2166-5GB10-8K	220-320
200	332	50kA	3VA1440-5MH32-0AA0	400	3RT1075	400	3RU2176-5HB10-8K	280-400
250	416	50kA	3VA1450-5MH32-0AA0	500	3RT1076	500	3RU2176-5JB10-8K	350-500

## Star-Delta feeder

kW 415V, 3ph, 50/60 Hz	Rated current IL (A)	Phase Current Iph (A)	Breaking Capacity Iq	Circuit Breaker		Contactor (Line/ Delta)		Contactor (Star)		Bi-relay	
				MCCB	Rated current In (A)	Type	Rating (A)	Type	Rating (A)	Type	Range (A)
37	64	37	50kA	3VA1180-5MH32-0AA0	80	3RT2037	65	3RT2027	32	3RU2136-4GB0	36...45
45	77	45	50kA	3VA1110-5MH32-0AA0	100	3RT2038	80	3RT2035	40	3RU2136-4HB0	40...50
55	94	54	50kA	3VA1112-5MH32-0AA0	125	3RT2038	80	3RT2036	50	3RU2136-4QB0	47...57
75	132	76	50kA	3VA1216-5MH32-0AA0	160	3RT1054	115	3RT2037	65	3RU2156-5BB10-8K	70-100
90	155	90	50kA	3VA1220-5MH32-0AA0	200	3RT1055	150	3RT2038	80	3RU2156-5BB10-8K	70-100
110	186	108	50kA	3VA1325-5MH32-0AA0	250	3RT1056	185	3RT2046	95	3RU2156-5CB10-8K	90-125
132	220	128	50kA	3VA1325-5MH32-0AA0	250	3RT1056	185	3RT1054	115	3RU2156-5DB10-8K	110-160
160	267	155	50kA	3VA1332-5MH32-0AA0	320	3RT1064	225	3RT1054	115	3RU2156-5EB10-8K	140-200
200	332	193	50kA	3VA1440-5MH32-0AA0	400	3RT1065	265	3RT1055	150	3RU2166-5FB10-8K	180-250
250	416	241	50kA	3VA1450-5MH32-0AA0	500	3RT1066	300	3RT1056	185	3RU2166-5GB10-8K	220-320

Note: For ratings below 37kW, with SCPD 3RV MPCB, please refer to Low Voltage Control Products Price List or please contact your nearest Siemens Sales Office.

# Fuse protected selection type 2, Iq = 50kA, IS/IEC:60947-4-1 (3KL with 3RT & 3RU)

Suitable for IE2 motors

- The selection is valid only for complete Siemens combinations i.e. SDF + DIN Fuse + Contactor + Bi-relay (+ timer).
- In case this combination is changed to accommodate another brand/rating of SDF/DIN Fuse/Contactor/BMR, it shall be the responsibility of the person making such a change to assure type 2 performance.
- Selection is for normal starting conditions (class 10 feeder). (For heavy starting applications e.g. ID/FD fans, reciprocating compressor, ball mills etc., please consult Siemens.)
- The electronic star-delta timer type 3RP should be used in star-delta feeders.
- SDF: Switch Disconnecter Fuse. All fuses are DIN HRC type.
- Tested Type 2 combinations
- Low LCC = Low Life Cycle Cost

## Direct-on-line feeder, for Low LCC

SL Motor		SDF		Fuse		Contactor		Bi-Relay	
kW 415V, 3ph, 50/60 Hz	I <sub>L</sub> Amps	Type	Amp	Type	Amps	Type	Rating Amps	Type	Set-Range Amp
0.37	1.1	3KL811	20	3NA78040RC	4	3RT2015	7	3RU2116-0KB0	0.9 ... 1.25
0.55	1.4	3KL811	20	3NA78040RC	4	3RT2015	7	3RU2116-1AB0	1.1 ... 1.6
0.75	1.7	3KL811	20	3NA78010RC	6	3RT2015	7	3RU2116-1BB0	1.4 ... 2
1.1	2.4	3KL811	20	3NA78010RC	6	3RT2015	7	3RU2116-1DB0	2.2 ... 3.2
1.5	3.2	3KL811	20	3NA78030RC	10	3RT2015	7	3RU2116-1EB0	2.8 ... 4
2.2	4.8	3KL811	20	3NA78050RC	16	3RT2015	7	3RU2116-1GB0	4.5 ... 6.3
3.7	7.4	3KL811	20	3NA78070RC	20	3RT2024	12	3RU2126-1JB0	7...10
5.5	11.2	3KL812	32	3NA78100RC	25	3RT2024	12	3RU2126-1KB0	9 ... 12.5
7.5	15	3KL812	32	3NA78120RC	32	3RT2025	17	3RU2126-4AB0	11 ...16
11	21	3KL815	63	3NA78200RC	50	3RT2027	32	3RU2126-4DB0	20 ... 25
15	28	3KL815	63	3NA78220RC	63	3RT2035	40	3RU2136-4EB0	22 ... 32
18.5	34	3KL821	100	3NA78240RC	80	3RT2035	40	3RU2136-4FB0	28 ... 40
22	40	3KL821	100	3NA78240RC	80	3RT2036	50	3RU2136-4GB0	36 ... 45
30	57	3KL821	100	3NA78300RC	100	3RT2037	65	3RU2136-4QB0	47 ... 57
37	64	3KL822	125	3NA78320RC	125	3RT2038	80	3RU2136-4KB0	62 ... 73
45	77	3KL822	125	3NA78320RC	125	3RT2046	95	3RU2136-4RB0	70 ... 80
55	101	3KL823	160	3NA78360RC	160	3RT1054	115	3RU2156-5CB10-8K	90 ... 125
75	134	3KL831	200	3NA71400RC	200	3RT1055	150	3RU2156-5DB10-8K	110 ... 160
90	160	3KL832	250	3NA71440RC	250	3RT1056	185	3RU2156-5EB10-8K	140 ... 200
110	190	3KL832	250	3NA71440RC	250	3RT1064	225	3RU2166-5FB10-8K	180 ... 250
132	228	3KL833	315	3NA72520RC	315	3RT1065	265	3RU2166-5FB10-8K	180 ... 250
160	269	3KL834	400	3NA72600RC	400	3RT1066	300	3RU2166-5GB10-8K	220 ... 320
200	350	3KL841	500	3NA33650RC	500	3RT1075	400	3RU2176-5HB10-8K	280 ... 400
250	430	3KL841	500	3NA33650RC	500	3RT1076	500	3RU2176-5JB10-8K	350 ... 500

## Star-Delta feeder, for Low LCC

SL Motor			SDF		HRC Fuses		Contactor Line/Delta		Contactor Star		Bi-Relay		Timer
kW 415V, 3ph, 50/60 Hz	I <sub>L</sub> Amps	I <sub>Ph</sub> Amps	Type	Rating Amps	Type	Rating Amps	Type	Rating Amps	Type	Rating Amps	Type	Set-Range Amp	Type
4	7.8	4.5	3KL811	20	3NA78030RC	10	3RT2023	9	3RT2023	9	3RU2126-1FB0	3.5 ... 5	3RP15
5.5	11.2	6.5	3KL811	20	3NA78050RC	16	3RT2023	9	3RT2023	9	3RU2126-1HB0	5.5 ... 8	3RP15
7.5	15	9.2	3KL811	20	3NA78070RC	20	3RT2024	12	3RT2023	9	3RU2126-1JB0	7 ... 10	3RP15
11	21	12	3KL812	32	3NA78100RC	25	3RT2025	17	3RT2023	9	3RU2126-1KB0	9 ... 12.5	3RP15
15	28	16.2	3KL812	32	3NA78120RC	32	3RT2026	25	3RT2025	17	3RU2126-4BB0	14 ... 20	3RP15
18.5	34	19.7	3KL815	63	3NA78200RC	50	3RT2027	32	3RT2026	25	3RU2126-4CB0	17 ... 22	3RP15
22	40	23.2	3KL815	63	3NA78200RC	63	3RT2035	40	3RT2026	25	3RU2136-4DB0	18 ... 25	3RP15
30	57	30.6	3KL821	100	3NA78220RC	80	3RT2035	40	3RT2026	25	3RU2136-4EB0	22 ... 32	3RP15
37	64	37.5	3KL821	100	3NA78240RC	80	3RT2035	40	3RT2027	32	3RU2136-4FB0	28 ... 40	3RP15
45	77	45	3KL821	100	3NA78300RC	100	3RT2037	65	3RT2028	40	3RU2136-4HB0	40 ... 50	3RP15
55	101	55.4	3KL821	100	3NA78300RC	100	3RT2037	65	3RT2035	40	3RU2136-4JB0	54 ... 65	3RP15
75	134	75.6	3KL823	160	3NA78360RC	160	3RT2038	80	3RT2037	65	3RU2136-4RB0	70 ... 80	3RP15
90	156	90	3KL823	160	3NA78360RC	160	3RT2046	95	3RT2038	80	3RU2146-4LB0	70 ... 90	3RP15
110	190	113	3KL831	200	3NA71400RC	200	3RT1054	115	3RT1054	115	3RU2156-5CB10-8K	90 ... 125	3RP15
132	228	133	3KL832	250	3NA71440RC	250	3RT1055	150	3RT1054	115	3RU2156-5DB10-8K	110 ... 160	3RP15
160	269	162	3KL833	315	3NA72520RC	315	3RT1056	185	3RT1054	115	3RU2156-5EB10-8K	140 ... 200	3RP15
200	350	202	3KL834	400	3NA72600RC	400	3RT1064	225	3RT1056	185	3RU2166-5FB10-8K	180 ... 250	3RP15
250	430	248	3KL841	500	3NA33650RC	500	3RT1075	400	3RT1065	265	3RU2166-5GB10-8K	220 ... 320	3RP15

# Fuse protected selection type 2, Iq = 50kA, IS/IEC:60947-4-1 (3KL with 3TF & 3UA)

Suitable for IE2 motors

- The selection is valid only for complete Siemens combinations i.e. SDF + DIN Fuse + Contactor + Birelay (+ timer).
- In case this combination is changed to accommodate another brand/rating of SDF/DIN Fuse/Contactor/BMR, it shall be the responsibility of the person making such a change to assure type 2 performance.
- Selection is for normal starting conditions with starting time ≤ 6 seconds. (For heavy starting applications e.g. ID/FD fans, reciprocating compressor, ball mills etc., please consult Siemens.)
- At 60°C service temperature the bi-relay has to be derated. The bi-relay can be used upto the maximum current setting indicated. For example - A bi-relay with setting 32-50A, at 60°C can be used only upto 47A. This however does not mean that at 60°C, the 50A setting corresponds to 47A. It means that, the bi-relay should not be set beyond 47A.
- The electronic star-delta timer type 3RP should be used in star-delta feeders.
- SDF: Switch Disconnector Fuse. All fuses are DIN HRC type.
- Tested Type 2 combinations
- Low LCC = Low Life Cycle Cost

## Direct-on-line feeder, for Low LCC

SL Motor kW 415V, 3ph, 50Hz	Motor I <sub>L</sub> Amp	SDF		HRC Fuse		Contactor		Bi-Relay		Bi-Relay	
		Type	Rating	Type	Amp	Type	Amp	Type (50°C)	Set-Range Amp	Type (60°C)	Available Set- Range Amp
0.37	1	3KL811	20	3NA78040RC	4	3TF30	9	3UA5000-0K	0.8 - 1.25	3UA5000-0K	0.8 - 1.17
0.55	1.3	3KL811	20	3NA78040RC	4	3TF30	9	3UA5000-1A	1 - 1.6	3UA5000-1A	1 - 1.5
0.75	1.9	3KL811	20	3NA78010RC	6	3TF30	9	3UA5000-1B	1.25 - 2	3UA5000-1B	1.6 - 2.3
1.1	2.6	3KL811	20	3NA78010RC	6	3TF30	9	3UA5000-1D	2 - 3.2	3UA5000-1D	2 - 3
1.5	3.7	3KL811	20	3NA78030RC	10	3TF30	9	3UA5000-1E	2.5 - 4	3UA5000-1E	2.5 - 3.7
2.2	4.8	3KL811	20	3NA78050RC	16	3TF30	9	3UA5000-1F	3.2 - 5	3UA5000-1G	4 - 5.9
3.7	7.8	3KL811	20	3NA78070RC	20	3TF30	9	3UA5000-1H	5 - 8	3UA5000-1J	6.3 - 9.4
5.5	11.2	3KL812	32	3NA78100RC	25	3TF31	12	3UA5000-1K	8 - 12.5	3UA5000-1K	8 - 11.7
7.5	16	3KL812	32	3NA78120RC	32	3TF32	16	3UA5200-2A	10 - 16	3UA5200-2B	12.5 - 18.7
9.3	19	3KL815	63	3NA78200RC	50	3TF34	32	3UA5500-2B	12.5 - 20	3UA5500-2C	16 - 23.4
11	20.8	3KL815	63	3NA78200RC	50	3TF34	32	3UA5500-2C	16 - 25	3UA5500-2C	16 - 23.4
15	28	3KL815	63	3NA78220RC	63	3TF34	32	3UA5500-2D	20 - 32	3UA5500-2D	20 - 30
18.5	34	3KL815	63	3NA78220RC	63	3TF35	38	3UA5500-2Q	25 - 36	3UA5500-2R	32 - 37.4
22	40	3KL817	100	3NA78240RC	80	3TF46	45	3UA5800-2FZ1	32 - 50	3UA5800-2FZ1	32 - 47
30	53	3KL817	100	3NA78300RC	100	3TF47	63	3UA5800-2TZ1	40 - 57	3UA5800-2PZ1	50 - 59
37	65	3KL822	125	3NA78320RC	125	3TF477	70	3UA5800-2VZ2	57 - 70	3UA5800-2VZ2	57 - 65.5
45	78	3KL822	125	3NA78320RC	125	3TF49	85	3UA5800-8YZ1	70 - 95	3UA5800-8YZ1	70 - 88.9
55	96	3KL823	160	3NA78360RC	160	3TF50	110	3UA5830-5C	85 - 105	3UA5830-5C	85 - 98.2
75	131	3KL831	200	3NA71400RC	200	3TF51	140	3UA6230-5A	85 - 135	3UA6230-5B	115 - 168
90	156	3KL832	250	3NA71440RC	250	3TF52	170	3UA6230-5B	115 - 180	3UA6230-5B	115 - 168
110	189	3KL832	250	3NA71440RC	250	3TF53	205	3UA6230-5C	160 - 250	3UA6230-5C	160 - 234
132	227	3KL833	315	3NA72520RC	315	3TF54	250	3UA6230-5C	160 - 250	3UA6230-5C	160 - 234
160	271	3KL834	400	3NA72600RC	400	3TF55	300	3UA6230-5D	200 - 320	3UA6230-5D	200 - 299
200	339	3KL841	500	3NA33650RC	500	3TF56	400	3UA6230-5E	250 - 400	3UA6230-5E	250 - 374
250	398	3KL841	500	3NA33650RC	500	3TF57	475	3UA6830-5F	320 - 500	3UA6830-5F	320 - 468

## Star-Delta feeder, for Low LCC

SL Motor kW 415V, 3ph, 50Hz	Motor		SDF		HRC Fuses		Contactor Line/Delta		Contactor Star		Bi-Relay		Bi-Relay		Timer
	I <sub>L</sub> Amp.	I <sub>ph</sub> Amp	Type	Rating	Type	Amp	Type	Amp	Type	Amp	Type (50°C)	Set- Range Amp	Type (60°C)	Available Set-Range Amp	Type
3.7	7.8	4.5	3KL811	20	3NA78030RC	10	3TF30	9	3TF30	9	3UA5000-1F	3.2-5	3UA5000-1F	3.2-4.7	3RP15
5.5	11.2	6.5	3KL811	20	3NA78050RC	16	3TF30	9	3TF30	9	3UA5000-1H	5-8	3UA5000-1H	5-7.5	3RP15
7.5	16	9.2	3KL811	20	3NA78070RC	20	3TF31	12	3TF30	9	3UA5000-1J	6.3-10	3UA5000-1J	6.3-9.4	3RP15
9.3	19	11	3KL812	32	3NA78100RC	25	3TF31	12	3TF30	9	3UA5000-1K	8-12.5	3UA5000-1K	8-11.7	3RP15
11	20.8	12	3KL812	32	3NA78100RC	25	3TF31	12	3TF30	9	3UA5000-1K	8-12.5	3UA5000-2S	10-13.6	3RP15
15	28	16.2	3KL812	32	3NA78120RC	32	3TF33	22	3TF32	16	3UA5200-2B	12.5-20	3UA5200-2B	12.5-18.7	3RP15
18.5	34	19.7	3KL815	63	3NA78200RC	50	3TF34	32	3TF34	32	3UA5500-2B	12.5-20	3UA5500-2C	16-23.4	3RP15
22	40	23.2	3KL815	63	3NA78200RC	50	3TF34	32	3TF34	32	3UA5500-2C	16-25	3UA5500-2D	22-30	3RP15
30	53	30.6	3KL815	63	3NA78220RC	63	3TF34	32	3TF34	32	3UA5500-2D	20-32	3UA5500-2Q	25-33.7	3RP15
37	65	37.5	3KL817	100	3NA78240RC	80	3TF35	38	3TF34	32	3UA5500-2R	32-40	3UA5500-8M	36-45	3RP15
45	78	45	3KL817	100	3NA78300RC	100	3TF46	45	3TF34	32	3UA5800-2FZ1	32-50	3UA5800-2FZ1	32-47	3RP15
55	96	55.4	3KL817	100	3NA78300RC	100	3TF47	63	3TF34	32	3UA5800-2TZ1	40-57	3UA5800-2PZ1	50-59	3RP15
75	131	75.6	3KL823	160	3NA78360RC	160	3TF49	85	3TF47	63	3UA5800-8YZ1	70-95	3UA5800-8YZ1	70-88.9	3RP15
90	156	90.1	3KL823	160	3NA78360RC	160	3TF50	110	3TF47	63	3UA5830-5B	70-95	3UA5830-5C	85-98.2	3RP15
110	189	109	3KL831	200	3NA71400RC	200	3TF50	110	3TF50	110	3UA5830-5D	95-120	3UA5830-5D	95-112	3RP15
132	227	131.1	3KL832	250	3NA71440RC	250	3TF51	140	3TF50	110	3UA6230-5B	115-180	3UA6230-5B	115-168	3RP15
160	271	156.5	3KL833	315	3NA72520RC	315	3TF52	170	3TF50	110	3UA6230-5B	115-180	3UA6230-5B	115-168	3RP15
200	339	195.7	3KL834	400	3NA72600RC	400	3TF54	250	3TF52	170	3UA6230-5C	160-250	3UA6230-5C	160-234	3RP15
250	398	229.8	3KL841	500	3NA72600RC	400	3TF54	250	3TF54	250	3UA6230-5C	160-250	3UA6230-5D	200-299	3RP15

Type-2 Coordination Charts



# One system. Worldwide application.

## The 3VA moulded case circuit breaker with UL certification

We have good news for machine and switchgear manufacturers who export worldwide: The 3VA5 and 3VA6 series of our 3VA moulded case circuit breakers with UL certification comply with the UL 489 standard as well as the IEC 60947 standard. All the functionalities of this modular and highly variable moulded case circuit breaker system can be used in plants that are operated, for example, in North America or Europe. The 3VA moulded case circuit breaker: One system. Worldwide application.

For more information, call us on 1800 209 1800 or visit us at [www.siemens.com/3VA](http://www.siemens.com/3VA)

For life cycle support for products, systems and solutions, call us at 1800 209 0987 or email us at [ics.india@siemens.com](mailto:ics.india@siemens.com)

[www.siemens.com/3VA](http://www.siemens.com/3VA)

**SIEMENS**



IoT-Cloud apps and remote monitoring

→ "Cloud / apps"



Connectivity and on-premise monitoring

→ "Software / gateway"



Field devices and sensors

→ "Things"



**SENTRON**  
Powermind



7KN Powercenter 3000



3WA / 3WL

3VA

7KM PAC3220

# SENTRON Digitalization Solution

## Intelligent power distribution management

**Secure. Scalable. Customizable.**

Turn your LV Panels into IoT enabled digital switchboards with benefits like:



On-site or cloud-based data visualization and analysis



Fulfill regulatory requirements (e.g., ISO 50001)



Energy transparency and efficiency without compromising security



Reduce unplanned downtime with condition monitoring

**Siemens/SENTRON-Digitalization**



MindSphere



Watts



SENTRON powermanager



SENTRON powerconfig



Adaptive web interface

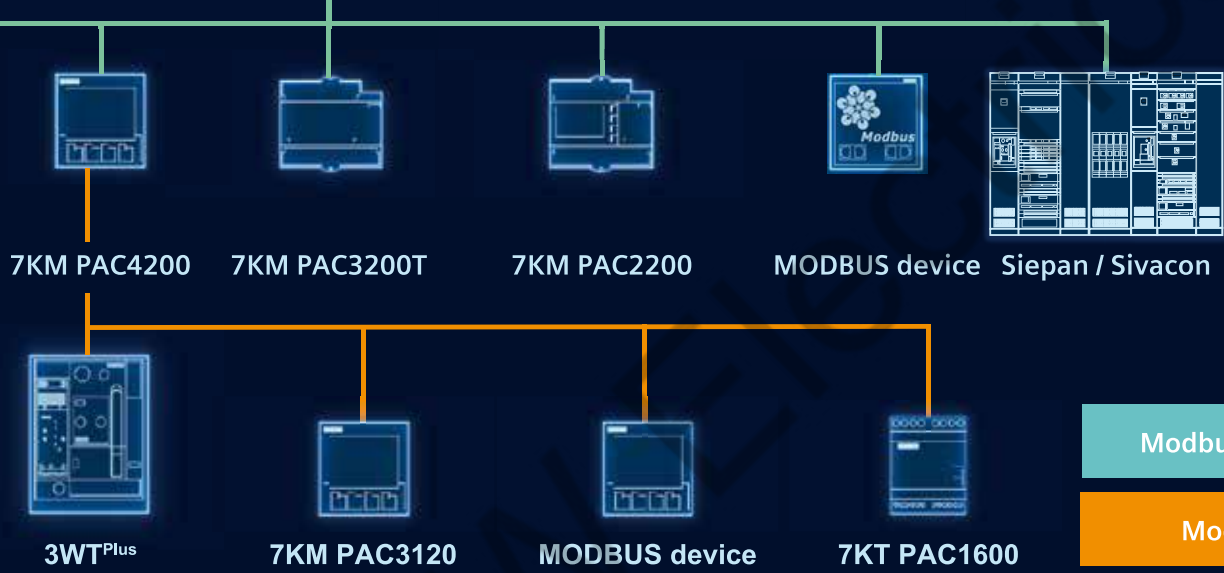

7KM PAC4200

7KM PAC3200T

7KM PAC2200

MODBUS device

Siepan / Sivacon

3WTPlus

7KM PAC3120

MODBUS device

7KT PAC1600

Modbus TCP / HTTP

Modbus RTU

WVO

Scan to explore



SIEMENS

## Available till stocks last

### Superswitch 3KL8

Switch Disconnecter fuse: 3KL8 3-pole with Isolable neutral (Open Execution)

Rated current I <sub>e</sub> @690V 50Hz	SDF suitable for DIN type HRC fuses	Unit MRP* ₹	SDF suitable for BS type HRC fuses	Unit MRP* ₹	SDF suitable for Cylindrical type HRC fuses	Unit MRP* ₹	Std. pkg. (nos.)
20A	3KL8111-3TA00	4015.-	3KL8111-3TJ00	3885.-	3KL8111-3TC00	3955.-	1
32A	3KL8121-3TA00	4115.-	3KL8121-3TJ00	4020.-	3KL8121-3TC00	4075.-	1
63A	3KL8151-3TA00	5805.-	3KL8151-3TJ00	5620.-	3KL8151-3TC00	5665.-	1
100A	3KL8211-3TA00	11600.-	3KL8211-3TJ00	11380.-			1
125A	3KL8221-3TA00	15170.-	3KL8221-3TJ00	14970.-			1
160A <sup>§</sup>	3KL8231-3TA00	16555.-	3KL8231-3TJ00	16325.-			1
200A	3KL8311-3UA00	21150.-	3KL8311-3UJ00	20470.-			1
250A	3KL8321-3UA00	24870.-	3KL8321-3UJ00	25310.-			1
315A	3KL8331-3UA00	30745.-	3KL8331-3UJ00	29945.-			1
400A <sup>§</sup>	3KL8341-3UA00	37040.-	3KL8341-3UJ00	37595.-			1
500A	3KL8411-3UA00	57950.-	3KL8411-3UJ00	55730.-			1
630A	3KL8421-3UA00	59535.-	3KL8421-3UJ00	57745.-			1
800A <sup>§</sup>	3KL8431-3UA00	64490.-	3KL8431-3UJ00	62585.-			1

Notes:

3KL8/ 3KA8 is rated for 690V, 50Hz, AC23A Utilisation Category  
\$ AC23A @500V AC

All SDF Unit MRPs are without fuses

Unit MRPs are inclusive of front drive (Handle) kit, fuse cover, terminal cover, isolable neutral cover and phase barriers.

### Accessories for 3KL8 / 3KA8: 3-pole with Isolable neutral (Open Execution)

Description	3KL81 11/21/51 3KA81 51	Unit MRP* ₹	3KL82 11/21/31 3KA82 11/21/31	Unit MRP* ₹	3KL83 11/21/31/41 3KA83 11/21/41/51	Unit MRP* ₹	3KL84 11/21/31 3KA84 3/4/5/6	Unit MRP* ₹	Std. pkg. (nos.)
Fuse Cover	3KX8150-0AC	485.-	3KX8230-0AC	700.-	3KX8340-0AC	1025.-	3KX8430-0AC	1450.-	1
Terminal Cover (1 set)	-	-	3KX8231-0AC	590.-	3KX8341-0AC	1120.-	3KX8431-0AC	1310.-	1
Isolable Neutral cover	-	-	3KX8232-0AC	295.-	3KX8342-0AC	480.-	3KX8432-0AC	590.-	1
Phase Barrier <sup>§§</sup>	3KX8153-0AC	200.-	3KX8233-0AC	200.-	3KX8343-0AC	290.-	3KX8433-0AC	370.-	1

§§ For phase barriers of BS type switches please contact your nearest Siemens Sales Office.

### SIECAP™ LV Power Capacitors

ND (Normal Duty)

Rated voltage V	kvar @ 50 Hz	Type	Unit LP* ₹	Std. pkg. (nos.)	Rated voltage V	kvar @ 50 Hz	Type	Unit LP* ₹	Std. pkg. (nos.)	
440	0.9	4RB2008-3EE50-8K	395.-	1	480	1	4RB2010-3EJ50-8K	455.-	1	
	1	4RB2010-3EE50-8K	440.-	1		1.5	4RB2015-3EJ50-8K	685.-	1	
	1.2	4RB2012-3EE50-8K	515.-	1		2	4RB2020-3EJ50-8K	900.-	1	
	1.5	4RB2015-3EE50-8K	640.-	1		2.5	4RB2025-3EJ50-8K	1115.-	1	
	2.1	4RB2021-3EE50-8K	910.-	1		4.2	4RB2042-3EJ50-8K	1895.-	1	
	2.5	4RB2025-3EE50-8K	1080.-	1		5	4RB2050-3EJ50-8K	1990.-	1	
	3	4RB2030-3EE50-8K	1300.-	1		5.5	4RB2055-3EJ50-8K	2480.-	1	
	4.2	4RB2042-3EE50-8K	1810.-	1		8.3	4RB2083-3EJ50-8K	3305.-	1	
	5	4RB2050-3EE50-8K	2160.-	1		10.4	4RB2104-3EJ50-8K	4140.-	1	
	6	4RB2060-3EE50-8K	2280.-	1		11.1	4RB2111-3EJ50-8K	3840.-	1	
	7	4RB2070-3EE50-8K	2665.-	1		12.5	4RB2125-3EJ50-8K	4330.-	1	
	7.5	4RB2075-3EE50-8K	2855.-	1		13.8	4RB2138-3EJ50-8K	4775.-	1	
	8.3	4RB2083-3EE50-8K	3160.-	1		15	4RB2150-3EJ50-8K	5190.-	1	
	9	4RB2090-3EE50-8K	3425.-	1		16.7	4RB2167-3EJ50-8K	5770.-	1	
	10	4RB2100-3EE50-8K	3810.-	1		20.8	4RB2208-3EJ50-8K	7200.-	1	
	12.5	4RB2125-3EE50-8K	4110.-	1		25	4RB2250-3EJ50-8K	8645.-	1	
	15	4RB2150-3EE50-8K	4930.-	1		27.7	4RB2277-3EJ50-8K	9580.-	1	
	16.7	4RB2167-3EE50-8K	5485.-	1		30	4RB2300-3EJ50-8K	10380.-	1	
	20	4RB2200-3EE50-8K	6565.-	1						
	20.8	4RB2208-3EE50-8K	6835.-	1						
25	4RB2250-3EE50-8K	8220.-	1							
28	4RB2280-3EE50-8K	9205.-	1							
30	4RB2300-3EE50-8K	9865.-	1							

\* Purchase MOQ for our dealers is in multiples of standard packing, please contact your nearest Siemens Sales Office for further details

\* LP - List Price

\* MRP - Maximum Retail Price

## Discontinued products

### 3KC Automatic Transfer Controller

Description	Type
ATC 5300	3KC9000-8TL30

### Control switches 3ST

Switch	Description	Type
2-Pole On-Off <sup>1), 2)</sup>	415V, 50Hz/8.5A	■ 3ST1 400-0AF08 ■ 3ST1 400-1AH08
3-Pole On-Off <sup>1), 2)</sup>		
Ammeter selector	0-L1-L2-L3	■ 3ST1 400-2RQ08
Voltmeter selector	0-L1L2-L2L3-L3L1	■ 3ST1 400-1RK08

1) 12th place code '8' represents black knob. Replace it by '9' for red knob.

2) 9th place code 'A' represents rotation < 360°. For 360° rotation, replace it by 'B'

### Accessories for Superswitch: 3KL8/ 3KA8

Description	3KL83 11/21/31/41 3KA83 11/21/41	3KL84 11/21/31 3KA84 2/3/4/5/6	Std.pkg. (nos.)
Key interlock	3KX3588-1YP(.)#	3KX3588-1YP(.)#	1

# Type of keys are Type A - F depending on the last digit (.) to be replaced by letters A - F.

Description	Type
3VL MCCBs	3VL1 - 3VL8
3VL Accessories	3VL9... , 13VL9...

### 7KM PAC 3100 power monitoring device

Description	Type
PAC 3100 with integrated RS 485 port for MODBUS RTU	7KM3133-0BA00-3AA0
PAC 3200 with integrated ethernet port for MODBUS TCP	7KM2112-0BA00-3AA0

### Motor control switches 3LA0

Description		Motor output 415V, 50Hz, 3Ph kW	Type
In sheet steel housing	On/Off	7.5	■ 3LA0221-1YA
		30	■ 3LA0621-1YB
	System selector	5.5	3LA0222-1YA
		Reversing	5.5

### Moulded Case Circuit Breaker: 3VT1

Description	Type
3VT1 MCCBs	3VT17....
3VT91 Accessories	3VT91....

# One point contact for your service needs

The comprehensive range of services from Siemens is sure to cover the needs of the most varied users.

We offer structured services, designed to give you valuable support in every phase during the lifecycle of your low voltage products and panels – from warranty support to suitable retrofit solutions.

We educate and help to adopt products and solutions like energy management, condition monitoring, various application with analytic etc. through retrofit and technology upgrade, thereby helping to embark on the digitalization journey easily.

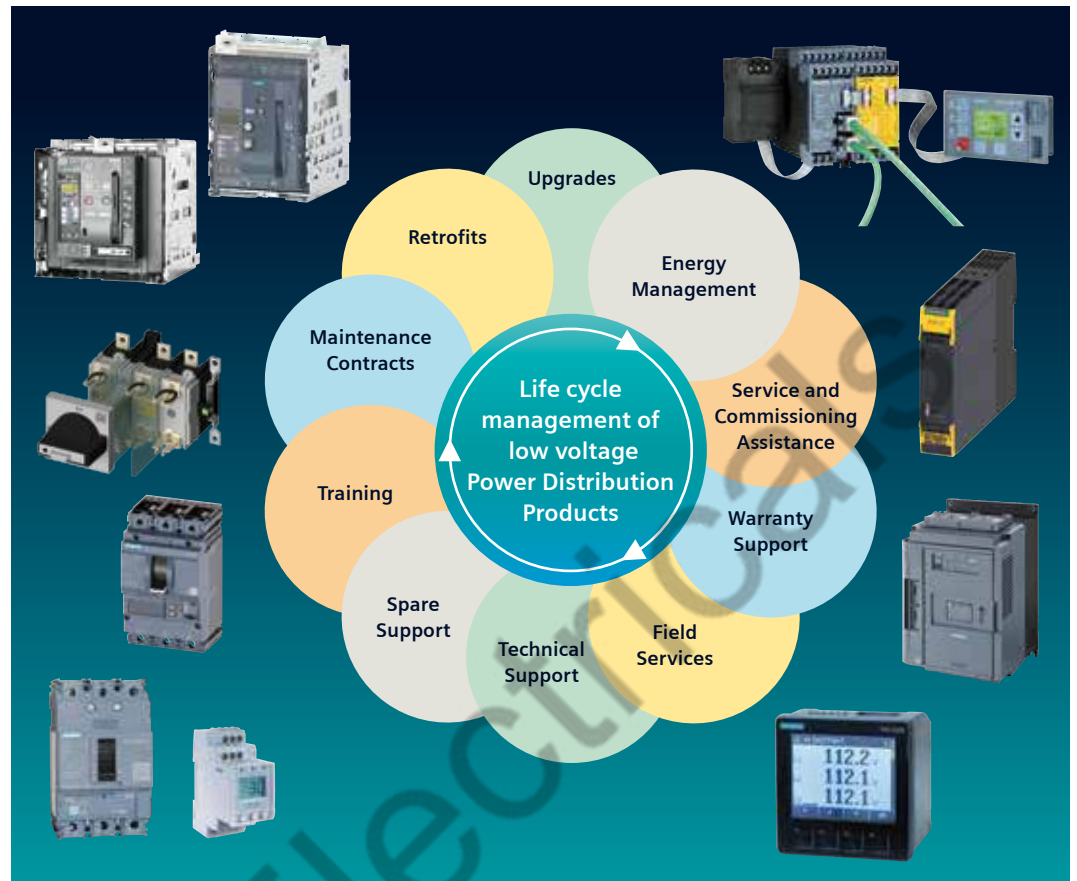

## Service & spares for SIEPAN 8PU

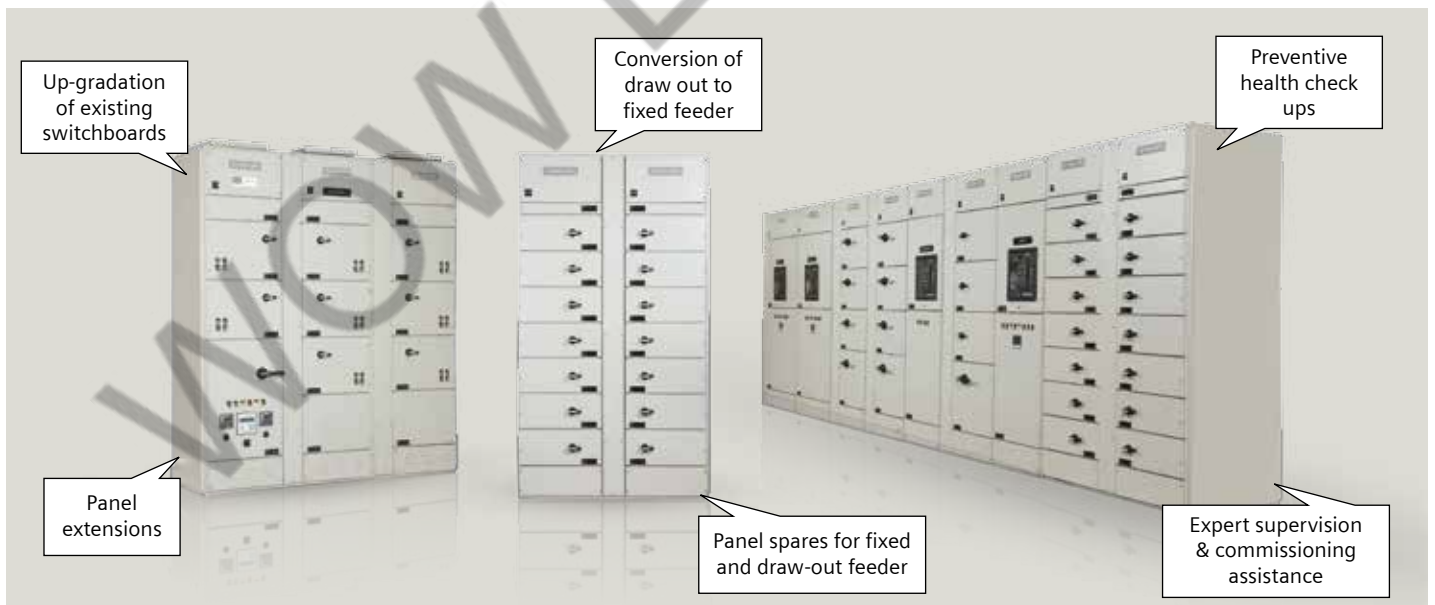

- Annual Maintenance contract of LV Switchboards
- Conversion of existing conventional to intelligent MCC
- Ready to use completely prewired draw out modules for MCC
- Upgradation of existing panels with temperature monitoring system

*Please get in touch with us for details*

**CUSTOMER CARE**  
**Toll Free No: 1800220987/18002090987 • E-mail: ics.india@siemens.com**

For information on prices of below products please refer to the  
Low Voltage Control Products valid Price List



## Terms and conditions

Maximum Retail Price (MRP) / List Price (LP) is subject to revision without prior notice.

The company reserves the right to supply goods at its works or godown at its discretion.

The minimum order size for non-stock items (items not marked with ■) is 50 Nos. for each item or ₹ 50,000/- per item.

**Export control regulation - retention clause:** The fulfillment of the agreement on Siemens part is subject to the provision that this shall not be prevented by implements on the grounds of national and international legal requirements, in particular export control provision.

### Stock items

The normal stock items (indicated by ■) are subject to change without prior notice.

### Note

- This supercedes all previous Price Lists.
- List Prices (LPs) mentioned are exclusive of all taxes.
- Maximum Retail Prices (MRPs) mentioned in the publication are maximum recommended selling prices.
- Invoice amount not to exceed MRP
- Invoice amount = MRP (less) applicable discount + applicable GST %
- For receiving material in factory sealed packing, we request you to order in multiples of the indicated standard packing quantity.

Ask your nearest Siemens partners to include you in our mailing list.

Always make your purchases only from our authorised dealers. Details available with our sales office/territory managers.





**SINOVA**  
Simply  
Efficient

# Low Voltage Electrical Products

**SIEMENS**

# Your partners

## Sales offices:

**Ahmedabad**  
3rd Floor, Prerna Arbour  
Chimanlal Giridharlal Road, Navarangpura  
Near Girish Colddrinks  
Ahmedabad, Gujarat - 380009  
Tel: +91 79 30927600  
Fax: +91 79 30927699

**Baroda**  
Ground Floor, Urja Bhavan  
Maneja Works, Opp. Makarpura Railway Station  
Vadodara - 390010  
Tel: +91 265 3957701  
Fax: +91 265 3039190

**Bengaluru**  
1st Floor, Jyoti Mahal, No. 49, St. Marks Rd.  
Bengaluru - 560 001  
Tel: +91 80 33422000  
Fax: +91 80 33424131

**Bhubaneswar**  
Mobile: +91 8696222212  
E-mail: rohit.nandan@siemens.com

**Chandigarh**  
Mobile: +91 9888484066  
E-mail: padam.sharma@siemens.com

**Chennai**  
4th Floor, ETA Mount Central  
Seethakathi Business Centre, Mount Road  
Chennai - 600006  
Tel: +91 44 30474000  
Fax: +91 44 30474080

**Coimbatore**  
Mobile: +91 9849001842  
E-mail: pramod.krishna@siemens.com

**Gurgaon**  
Plot No. 78, Tower - B  
Jagatjit Industries Building (JIL)  
Opposite SBI Academy, Sector-18  
Gurgaon - 122015  
Tel: +91 124 2842000, 3810200

**Hyderabad**  
5-9-19, 4th Floor, Lakshmi Narasinh Estate  
Hyderabad - 500004  
Tel: +91 40 23482578

**Jaipur**  
Mobile: +91 9815502480  
E-mail: rohit.jagga@siemens.com

**Jamshedpur**  
Mobile: +91 8294052647  
E-mail: shiyamal.bhattacharyya@siemens.com

**Kolkata**  
3rd Floor, 43, Shanti Palli  
Rashbihari Bypass Connector  
Kolkata - 700042, India  
Tel: +91 33 30939000  
Fax: +91 33 30939010

**Lucknow**  
Mobile: +91 9918002525  
E-mail: atul.shukla@siemens.com

**Mumbai**  
Business Centre-1, Kalwa Works  
Thane Belapur Road  
Thane - 400 601  
Tel: +91 22 39663000  
Fax: +91 22 39663721

**Nagpur**  
Mobile: +91 9619413628  
E-mail: sachin.shahane@siemens.com

**Pune**  
Tower C, Panchshil Business Park  
Survey No. 20, Balewadi  
Pune - 411045  
Tel: +91 20 30466000  
Fax: +91 20 30466006

**Vizag**  
Mobile: +91 9701354777  
E-mail: vijaykiran.meduri@siemens.com

## Territory managers:

**Agra**  
Mobile: +91 8802011478  
E-mail: singh.amar@siemens.com

**Aurangabad**  
Shailendra Kumar Maurya  
Flat 304, Ajinkya Palacia, Rajnagar MIDC  
Bansilal Nagar, Aurangabad - 431005  
Mobile: +91 9033563923  
E-mail: shailendra-kumar.maurya@siemens.com

**Belgaum**  
Plot No 11, Sharda Building Sahyadri Colony  
Angol-Vadagnv Road, Belgaum - 590006  
Mobile: +91 8105592066  
E-mail: siddu.mareguddi@siemens.com

**Bharuch**  
Bungalow No. 1, Sanskar Villa, Behind Yogi Petrol Pump  
Namada Chokdi, Zadeshwar, Bharuch - 392011  
Mobile: +91 8884000998  
E-mail: vival.kachhadia@siemens.com

**Bhilai**  
Flat No. 408, 5th Floor, Harihar Nagar  
Besa, Nagpur - 440037  
Mobile: +91 7869922211  
E-mail: pravin.deshbhatar@siemens.com

**Bilaspur**  
House No. 63, Rohini Vihar, Phase-1  
Near Agyey (Greenpark) Colony  
Bilaspur (C.G.) - 495001  
Mobile: +91 9827888436  
E-mail: chandan.gajpalla@siemens.com

**Boisar**  
Flat 110, Building M4, Tata Shubh Grih  
Maan, Opp. D Mart, Boisar - 401506  
Mobile: +91 9819231892  
E-mail: debashis.biswas@siemens.com

**Cochin**  
E27, Federal Park, Vennala P.O.  
Cochin - 682028, Kerala  
Mobile: +91 9447313241  
E-mail: max.tom@siemens.com

**Durgapur**  
Quarter No. C7, Kunustoria Area Complex  
Near Pragati Stadium, Raniganj - 713362, West Bengal  
Mobile: +91 9830317456  
E-mail: harsh.chincholkar@siemens.com

**Gandhidham**  
Plot No. 453, DC-5, Adipur, Gandhidham - 370205  
Mobile: +91 9725005162  
E-mail: maulikumar.patel@siemens.com

**Goa**  
949/C, Gandhi Road, Backbhat, Raia  
Salcete, Goa - 403720  
Mobile: +91 9112633253  
E-mail: vijaykumar.patil@siemens.com

**Gorakhpur**  
Mobile: +91 9889384222  
E-mail: umesh.pandey@siemens.com

**Guwahati Assam**  
Shivalaya Housing Society, Flat No. B-3A  
Bylane-4, Joymatinagar, Adabari, Pandu  
Guwahati - 781012, Assam  
Mobile: +91 9864110684  
E-mail: bilal.datta@siemens.com

**Haridwar**  
Mobile: +91 7983880015  
E-mail: akshit.tyagi@siemens.com

**Hosur**  
Mobile: +91 +91 9000451122  
E-mail: chandrashekar.r@siemens.com

**Hubli**  
Flat No. 303, Shriya Solitaire  
Opp. Murudeshwar Ceramic Factory  
RN Shetty Road, Hubli, Karnataka - 580024  
Mobile: +91 9945961052  
E-mail: kiran.kage@siemens.com

**Hospet**  
Mahalakshmi Badavane 22nd Ward, 1st Cross  
House No. C-5A, MP Prakash Nagar  
Landmark - Behind Markandeswara Govt. School  
Post: Hospet, Dist: Bellary, Karnataka - 583201  
Mobile: +91 9945859004  
E-mail: nagaraj.rk@siemens.com

**Indore**  
78, Anand Nagar, Chitwad Road, Indore - 452001 (MP)  
Mobile: +91 9673333024  
E-mail: brajesh.rathor@siemens.com

**Jalandhar**  
H.No. 212A, Punjabi Bahg Extension, 66 Feet Road  
Near Curo Mall, Jalandhar, Punjab - 144022  
Mobile: +91 9876047929  
E-mail: sunil.singla@siemens.com

**Jammu**  
Plot No. 592/3, 2nd Floor, Bhawani Vihar Extension  
Trikuta Nagar, Jammu -180020  
Mobile: +91 9873084776  
E-mail: sharma.nikhil@siemens.com

**Jodhpur**  
17 E 730 Chopasni H.B.Colony  
Jodhpur - 342008, Rajasthan  
Mobile: +91 8003088889  
E-mail: ankur.pancholi@siemens.com

**Kanpur**  
Plot No. 323, Flat No. 11, Ratan Lal Nagar  
Kanpur, Uttar Pradesh - 208022  
Mobile: +91 8802011478  
E-mail: singh.amar@siemens.com

**Kolhapur**  
Mobile: +91 9112633253  
E-mail: vijaykumar.patil@siemens.com

**Kota**  
A-1, 1st Floor, Shreenath Estate  
Station Road, Kota, Rajasthan - 324002  
Mobile: +91 9929110492  
E-mail: rajendra.kabra@siemens.com

**Ludhiana**  
House No. 548, FF Urban Estate, Phase 1, Jamalpur  
Chandigarh Road, Ludhiana - 141003 Punjab  
Mobile: +91 9872131762  
E-mail: gurvinder.singh@siemens.com

**Ludhiana**  
H.No. 1235, St. No. 3/1, Sardar Nagar, Rahon Road  
Near Gurudwara Mata Bhagwanti  
Ludhiana - 141007, Punjab  
Mobile: +91 9872419990  
E-mail: ravinder.pal@siemens.com

**Madurai**  
Dhanya Block, DF-02, Vasuthara Enclave  
84, TPK Main Road, Andal Puram  
Madurai - 625003, Tamil Nadu  
Mobile: +91 9626699692  
E-mail: balaji.sakthivel@siemens.com

**Mangalore**  
Grace, 3-4-433, Kadri Kambla Road, Bejai  
Mangalore - 575004, India  
Mobile: +91 9964070498  
E-mail: vishaljenen.dsouza@siemens.com

**Meerut**  
110, Lotus Towers, Opposite Ansal Courtyard  
Modipuram, Meerut - 250001, Uttar Pradesh  
Mobile: +91 7983880015  
E-mail: akshit.tyagi@siemens.com

**Mehsana**  
Mobile: +91 9909904993  
E-mail: piyush.thaker@siemens.com

**Mysore**  
No. 980, 4th Cross, 6th Main, Bannimantap B layout  
SS Nagar, Mysore - 570015  
Mobile: +91 9611311645  
E-mail: raashid.syed@siemens.com

**Naidupeta**  
110/21, 3rd Street, Kalpaga Nagar, Padianallur  
Redhills, Chennai - 600052  
Mobile: +91 8122072921  
E-mail: m.karthikeyan@siemens.com

**Nashik**  
Flat No. 301, "A" Wing, Hari Shrushti, Near Jogging Track  
Opposite WNS Indira Nagar, Nashik - 422009  
Mobile: +91 9892292275  
E-mail: dhananjay.thorat@siemens.com

**Neemrana**  
F 131, Japanese Zone, Anant Raj Apartments  
Neemrana, Alwar, Rajasthan - 301705, India  
Mobile: +91 9855526122  
E-mail: kumar.manish@siemens.com

**Patna**  
A-53, 5th Floor, Krishna Apartment  
Boring Road, Patna - 800001  
Mobile: +91 9641574289  
E-mail: rajendra.mitra@siemens.com

**Pondicherry**  
Door No. 102, Second Floor, Chellan Nagar, Main Road  
Near Rainbow Nagar Park, Pondicherry - 605011  
Mobile: +91 8939883966  
E-mail: kolappan.c@siemens.com

**Raipur**  
Jr.M.I.G 503 Chilpy Height, Bhawna Nagar  
Near Shankar Nagar, Raipur - 492007  
Mobile: +91 9926511479  
E-mail: ravindra.ughade@siemens.com

**Rajahmundry**  
D No. 8-23-2, Flat No. G2, Sri Lalitha Heights, 1st Floor  
Jammalamadaka Vari Street, Gandhinagar  
Kakinada-533004  
Mobile: +91 9642351144  
E-mail: venkateshwar.d@siemens.com

**Ranchi**  
Raj Enclave, Flat No. 204, 2nd Floor  
Kaju Bagan (Near DAV Hehal Jr. Section)  
Piska More, P.S. Sukhdeonagar, Ranchi - 834005  
Mobile: +91 9674011440  
E-mail: sarkar.saikat@siemens.com

**Renukoot**  
Plot No. 2, Ward No. 14, Near A1  
Turra Chauraha, Pipri, Renukoot Dist.  
Sonebhadra - 231221 (U.P.), Uttar Pradesh  
Mobile: +91 9984500021  
E-mail: kumardeepak@siemens.com

**Rourkela**  
U4/8, Civil Town Ship, 3rd Lane, Rourkela - 769004  
Mobile: +91 9861056581  
E-mail: ashirbad.das@siemens.com

**Rudrapur**  
Shanti Vihar Colony, Chatarpur Road  
Opposite Dr. Pandey Hospital, Rudrapur - 263153  
Distt. Udham Singh Nagar, Uttrakhand  
Mobile: +91 9839174578  
E-mail: girish.pandey@siemens.com

**Salem**  
Sri Krishna Nivasam Apartment, B2, 2nd Floor  
Vidya Ashramam Salai, Shankar Nagar, Salem - 636007  
Mobile: +91 9952389893  
E-mail: b.saravanan@siemens.com

**Silvassa**  
Flat No. 306, Dream Heights, Besides Jama Masjid  
Vapi Silvassa Road, Dunga, Vapi - 396193  
Mobile: +91 987021215  
E-mail: akif.qadeer@siemens.com

**Sonipat**  
Flat No. - B1206, Max Height Dream Home, Kundli  
Sonipat, Haryana - 131028  
Mobile: +91 9650481919  
E-mail: deepak.beniwal@siemens.com

**Sriperumbudur**  
No. 36, 2nd Floor, Jayasri Nagar, Pattunool Chathiram  
Sriperumbudur, Tamilnadu - 602105  
Mobile: +91 9071161117  
E-mail: mohanjai@siemens.com

**Surat**  
A1-504, Shradha Flats, Near Swastik Villa, Pal  
Surat - 395009  
Mobile: +91 9879110276  
E-mail: rahul.gangrade@siemens.com

**Trichy**  
Flat No. 57, 2nd Floor, A Block, Bharat Citi Squares  
5th Cross Extn, 1st Main Road, Ramalinga Nagar  
Woraiyur Trichy - 620003  
Mobile: +91 9840255185  
E-mail: r.pradeep@siemens.com

**Udaipur**  
H.No. 4, Humdo Ki Sehri, Near Badnor House  
Udaipur - 313001  
Mobile: +91 7073032555  
E-mail: yogesh.ordia@siemens.com

**Vapi**  
Flat No. 306, Dream Heights, Besides Jama Masjid  
Vapi Silvassa Road, Dunga, Vapi - 396193  
Mobile: +91 987021215  
E-mail: akif.qadeer@siemens.com

**Vapi**  
Flat No. 302, 3rd Floor, Samrajya-IV, Royal Residency  
Gokul Vihar Township, Charwada Road, Taluka- Pardi  
Dist. Valsad, Vapi - 396195  
Mobile: +91 9825147957  
E-mail: rohit.darji@siemens.com

**Vijayawada**  
D No. 39-15-3, Datti Simhadri Street  
Opp Taj Gateway Hotel, Labbipet, Vijayawada - 520010  
Mobile: +91 9666368553  
E-mail: ganesh.pillala@siemens.com

Siemens Limited  
Smart Infrastructure  
Electrical Products  
R&D Technology Centre  
Thane Belapur Road  
Airoli Node, Navi Mumbai - 400708  
For more information contact toll free 1800 209 1800  
E-mail: lvsg-rmktg.india@siemens.com

**www.siemens.co.in**

Order No.: 112980209  
SI-EP-PO-PL-1122  
(This replaces SI-EP-PO-PL-0422  
dated 15th April, 2022)

Customer Care Toll free no. 1800 209 0987  
Email: ics.india@siemens.com

Product upgradation is a continuous process. Hence, data in this pricelist is subject to change without prior notice. For the latest information, please get in touch with our Sales Offices.